



Perfect Appearance    Excellent Performance

精 于 静                      精 于 动

# EASY TRAINER 1280

## OPERATING MANUAL



<http://www.facebook.com/FMSmodel>



[www.fmsmodel.com](http://www.fmsmodel.com)

Please visit both our Facebook fanpage and our homepage for updated product information

# WARNING

 **WARNING:** Read the ENTIRE instruction manual to become familiar with the features of the product before operating. Failure to operate the product correctly can result in damage to the product, personal property and cause serious injury.

This is a sophisticated hobby product and NOT a toy. It must be operated with caution and common sense and requires some basic mechanical ability. Failure to operate this Product in a safe and responsible manner could result in injury or damage to the product or other property. This product is not intended for use by children without direct adult supervision.

This manual contains instructions for safety, operation and maintenance. It is essential to read and follow all the instructions and warnings in manual, prior to assembly, setup or use, in order to operate correctly and avoid damage or serious injury.

## Safety Precautions and Warnings

As the user of this product, you are solely responsible for operating in a manner that does not endanger yourself and others or result in damage to the product or the property of others. This model is controlled by a radio signal subject to interference from many sources outside your control. This interference can cause momentary loss of control so it is advisable to always keep a safe distance in all directions around your model, as this margin will help avoid collisions or injury.

Age Recommendation: Not for children under 14 years. This is not a toy.

- Never operate your model with low transmitter batteries.
- Always operate your model in an open area away from cars, traffic or people.
- Avoid operating your model in the street where injury or damage can occur.
- Never operate the model in the street or in populated areas for any reason.
- Carefully follow the directions and warnings for this and any optional support equipment (chargers, rechargeable battery packs, etc.) you use.
- Keep all chemicals, small parts and anything electrical out of the reach of children.
- Moisture causes damage to electronics. Avoid water exposure to all equipment not specifically designed and protected for this purpose.
- Never lick or place any portion of your model in your mouth as it could cause serious injury or even death.

## **FMS MODEL Friendly Reminder**



Thank you for purchasing a FMS MODEL product. Our goal is to provide high quality products and offer great customer service. If you have any problems with your product or want to offer suggestions for improvements (such as plane design, packaging, building instructions, etc.) please feel free to contact us at [info@fmsmodel.com](mailto:info@fmsmodel.com)

## *Table of contents*

<b><i>Kit contents</i></b> .....	<b>1</b>
<b><i>The spare parts list</i></b> .....	<b>2</b>
<b><i>Spare parts list content</i></b> .....	<b>3</b>
<b><i>The illustration of the spare parts</i></b> .....	<b>4</b>
<b><i>Kit inspection</i></b> .....	<b>5</b>
<b><i>Assemble the plane</i></b> .....	<b>6</b>
The control horns installation	
Install the horizontal stabilizer	
The transmitter and model setup	
Install the main wing	
Install the propeller set	
Install the battery	
The receiver connection	
The placement of the receiver	
<b><i>Get your model ready to fly</i></b> .....	<b>13</b>
Important ESC information	
The model and transmitter setup	
Check the control direction	
Install the canopy	
Flight control	
Check the C.G. (Center of Gravity)	
<b><i>Before the model flying</i></b> .....	<b>19</b>
Find a suitable flying site	
Perform the range check of your plane	
Monitor your flight time	
<b><i>Flying course</i></b> .....	<b>20</b>
Take off	
Flying	
Landing	
Maintenance	
<b><i>Troubleshooting</i></b> .....	<b>21</b>
<b><i>AMA</i></b> .....	<b>22</b>

## *Kit contents*



### **Kit contents**

1. The fuselage assembly ( Front gear, motor, ESC, propeller, canopy, motor hatch cover,)
2. Main wing set (A set of main wings with the flap and aileron control servos installed)
3. Horizontal Stabilizer with the elevator
4. wings tube
5. battery and charger (RTF version only)
6. Radio control system (RTF version only)

### ***The spare parts list***

Replacement parts for the EASY TRAINER 1280 are available using the order numbers in the Spare parts list that follows. The fastest, most economical service can be provided by your hobby dealer or mail-order company.

## Spare parts list content

SQ 101 Fuselage (With the motor board and extension wire installed)  
 SQ 102 Main wing set (With all the plastic part installed)  
 SQ 103 Horizontal Stabilizer  
 SQ 104 Canopy  
 SQ 105 Propeller  
 SQ 107 Linkage Rods  
 SQ 112 Sticker  
 SQ 113 Motor mount  
 SQ 114 Motor Board  
 SQ 115 Pipe  
 FMS-Battery-7.4V 1300mah 20C  
 FMS-Motor-3128 Kv2650  
 FMS-Servo-9g-positive  
 FMS-ESC-20A

## The illustration of the spare parts



SQ-101



SQ-102



SQ-103



SQ-104



SQ-105



SQ-107



SQ-112



SQ-113



SQ-114



SQ-115



FMS-Battery-7.4V  
1300mah 20C



FMS-Motor-3128 Kv2650



FMS-Servo-9g-positive



FMS-ESC-20A

## *Kit inspection*

Before starting to build, inspect the parts to make sure they are acceptable quality. If any parts are missing or are not in good shape or acceptable quality, or if you need assistance with setup and assembly, please feel free to contact ROC TEAM. Please write down the name of the parts when you are reporting defective or missing of them.

ROC TEAM Product Support

ADDRESS: 3/F, Building B, 3rd Industry Zone, Matigang, Dalingshan Town, Dongguan City, P.R.C

Ph: 0086-769-86976655

## *Charging the Flight Battery*

The Battery Charger included with your aircraft is designed to safely charge the Li-Po battery, **Caution:** All instructions and warnings must be followed exactly. Mishandling of Li-Po batteries can result fire, personal injury, or property damage.

### **Battery warning:**

- ◆ By handling, charging or using the included Li-Po battery you assume all risks associated with lithium batteries.
- ◆ If at any time the batteries begin to swell, or balloon, discontinue use immediately. Charge or discharge a swelling and ballooning battery can result fire.
- ◆ Always store the batteries at room temperature in a dry area for the extensive use of the battery. Always transport or temporarily store the battery in a temperature range of 40-120°F. Do not store battery or model in a car of direct sunlight. If stored in a hot car, the battery can be damaged or even catch fire.
- ◆ Never use a Ni-Mh charger. Failure to charge the battery with a compatible charger may cause fire resulting in personal injury and property damage.
- ◆ Never discharge Li-Po cells to below 3V.
- ◆ Never leave charging batteries unattended.
- ◆ Never charge damaged batteries.

### **Charging the flight battery**

Your ARF aircraft comes with a DC balancing charger. You must charge the battery with a Li-Po specific charger only (such as the included **BC-3S10** DC charger). when charging the battery, make certain the battery is on a heat-resistant surface, charge the battery before the assemble. Install the fully charged battery to perform control tests and binding.

### **BC-3S10 Balance Charger**

To correctly use the charger, please read the instruction before use.

## Charging the Flight Battery

### Electrical Parameters

Parameter	Min	Type	Max	Unit
Working Voltage	9	12	16	V
Input Power	15			W
Work Temperature	-20		45	°C
Store Temperature	-20		65	°C
Charging Stop Voltage	4.19	4.20	4.21	V
Charging Current			1000	mA
Balancing Current	150		200	mA
Activate Current	80		120	mA

#### Using Steps:

1. Connect charger to adapter with enough voltage and wattage, then the Power LED lights on;
2. Connect 2S/3S battery pack to the corresponding balance port (**Do not connect two battery packs at the same time**), then the Charge LED flicker (1Hz) and start charging.
3. When the Charge LED stop flicker, charging is completed, the batteries can be unplugged.

#### Charging Function Description

1. All voltage of the installed battery pack is higher than 4.18V, charging will not start, Charge LED shine.
2. The voltage of one battery or some batteries is lower than 0.7V, charging will not start. If the voltage of the first battery of 3S battery pack is lower than 0.7V, charger will charge the battery pack regarding as 2S battery pack.
3. The voltage of one battery or some batteries is lower than 2.8V, charger will activate the battery pack with small current. If the voltage can't be increased above 2.8V after half an hour, charger will judge the battery pack is bad. Charge LED rapid flicker (0.5Hz), charging stop.

#### Self Checking Function

1. Charger will check charging function before charge every time. Charge LED will rapid flicker (0.5Hz) if the charging function is abnormal;
2. Accuracy checking Function: Connect one 3S battery pack which all voltage are just 4.2V, Charge LED will flicker twice then shine always. It means the accuracy is normal. (Maybe user's voltage measurement equipment exist accuracy error, this function only for reference)

### The control horns installation

1. Install the horizontal stabilizer horns, fit the horn into the pre-notched slot on the down side of the horizontal stabilizer that contain the servos.



2. Place the backplate on the opposite side with the two small protrude collars filled into the control surface.

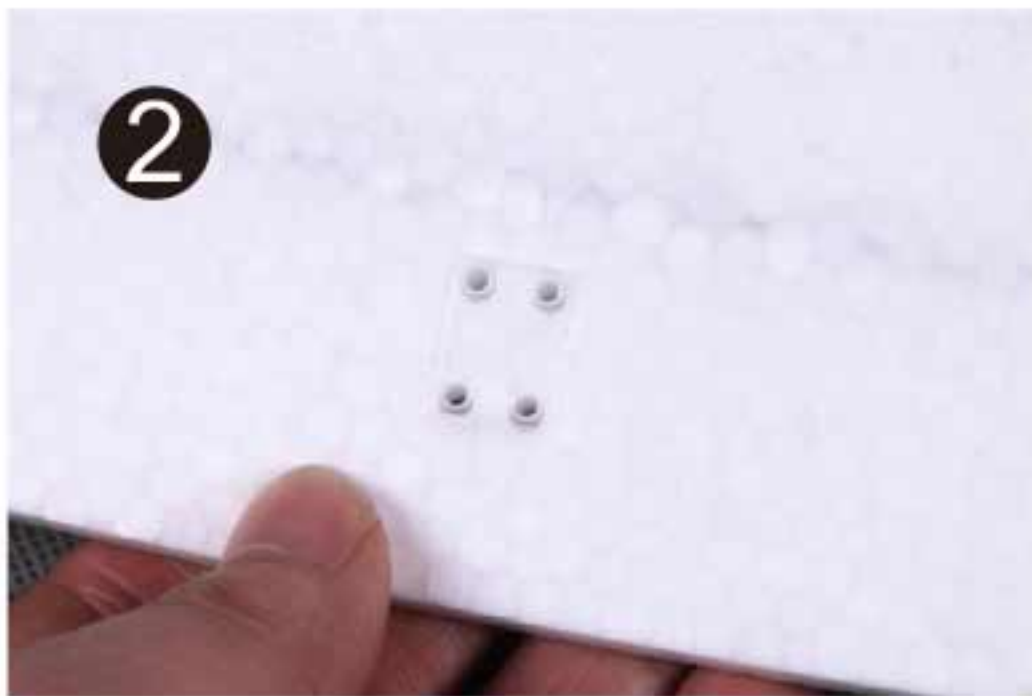

3. Secure the control horn from the horn mounting side using the provided screws. The shorter screws located on the trailing edge side, the horizontal stabilizer and tail horn securing screw are mounted the same. Make sure the control horns are facing the proper direction.

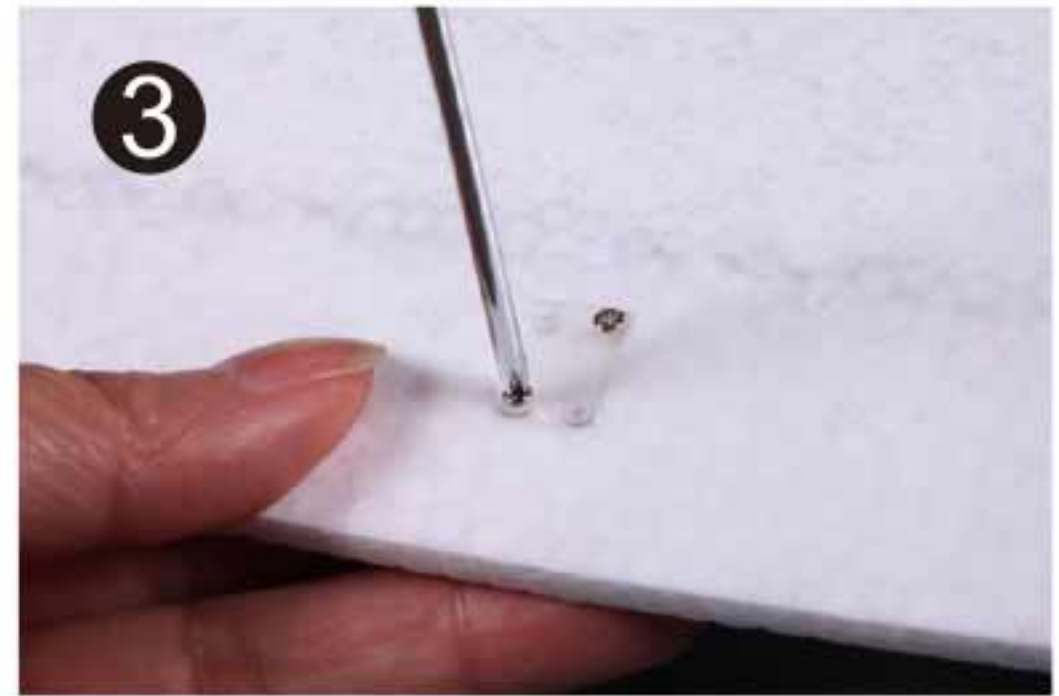

### Install the horizontal stabilizer

1. Apply glue on the combined side of the elevator.





## Assemble the plane

2. Insert two side of stabilizer into the rear fuselage, make sure two half stabilizer fully connect well.

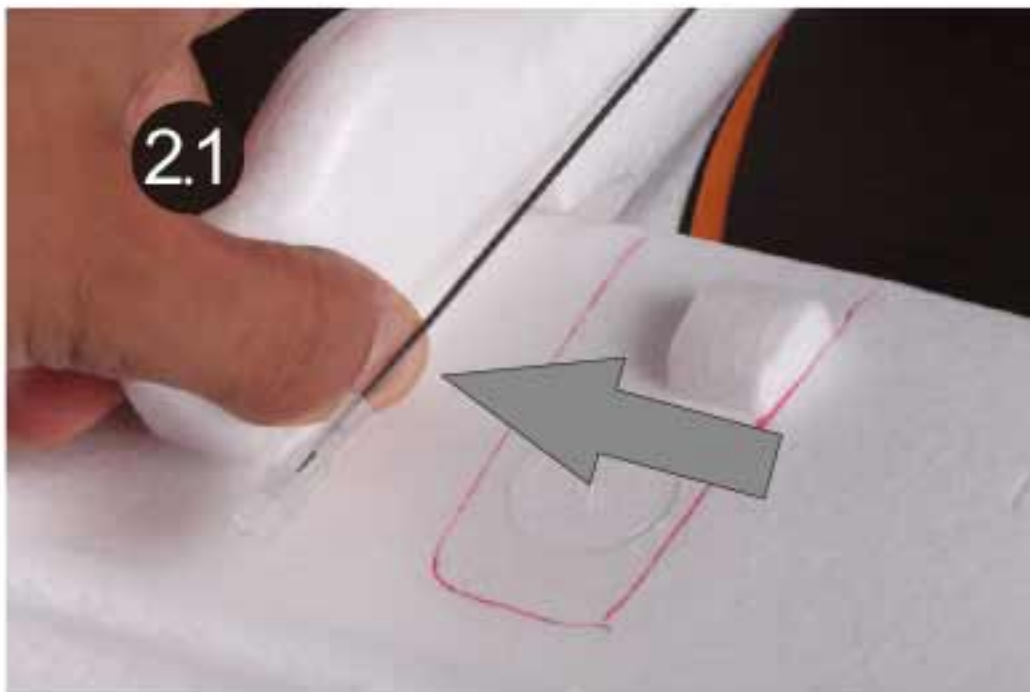

### The transmitter and model setup

Before getting started, bind your receiver with your transmitter. Please refer to your **Transmitter Manual** for proper operation.

**CAUTION:** To prevent personal injury, DO NOT install the propeller assembly onto the motor shaft while testing the control surfaces. DO NOT arm the ESC and do not turn on the transmitter until the **Transmitter Manual** instructs you to do so.

**Tips:** Make sure all control sticks on your radio are in the neutral position (rudder, elevator, ailerons) and the throttle in the OFF position. Make sure both ailerons move up and down (travel) the same amount. This model tracks well when the left and right ailerons travel the same amount in response to the control stick.

1. Connect the leads from the control surfaces and the ESC to the receiver.

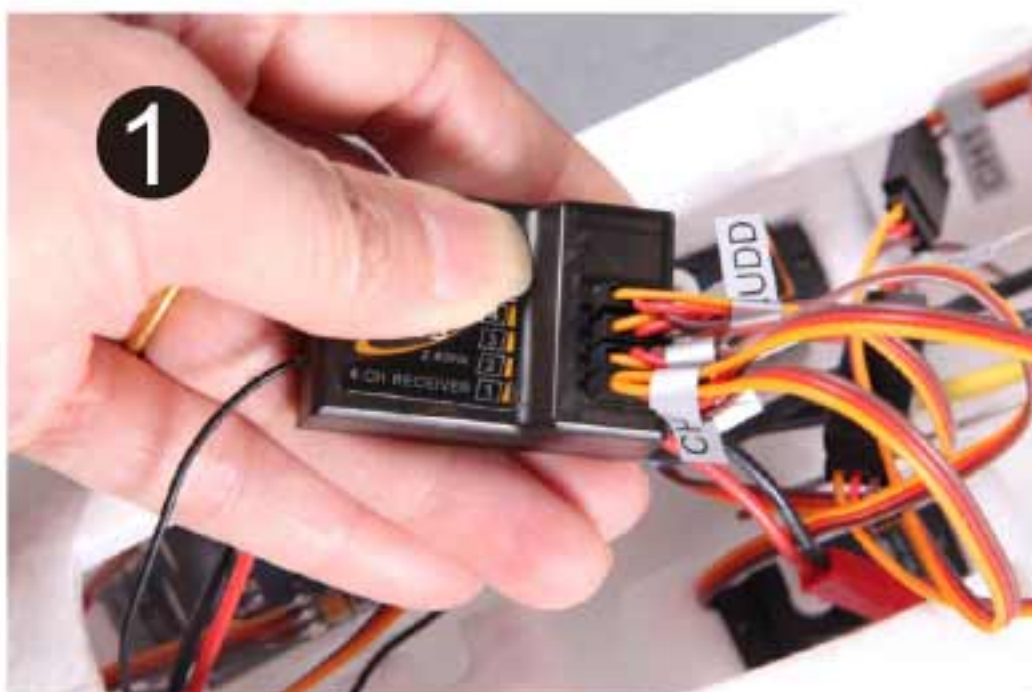

2. Turn on your transmitter and power up your ESC, make sure the servo arms are fully vertical with the servo before hooking the linkage rods.

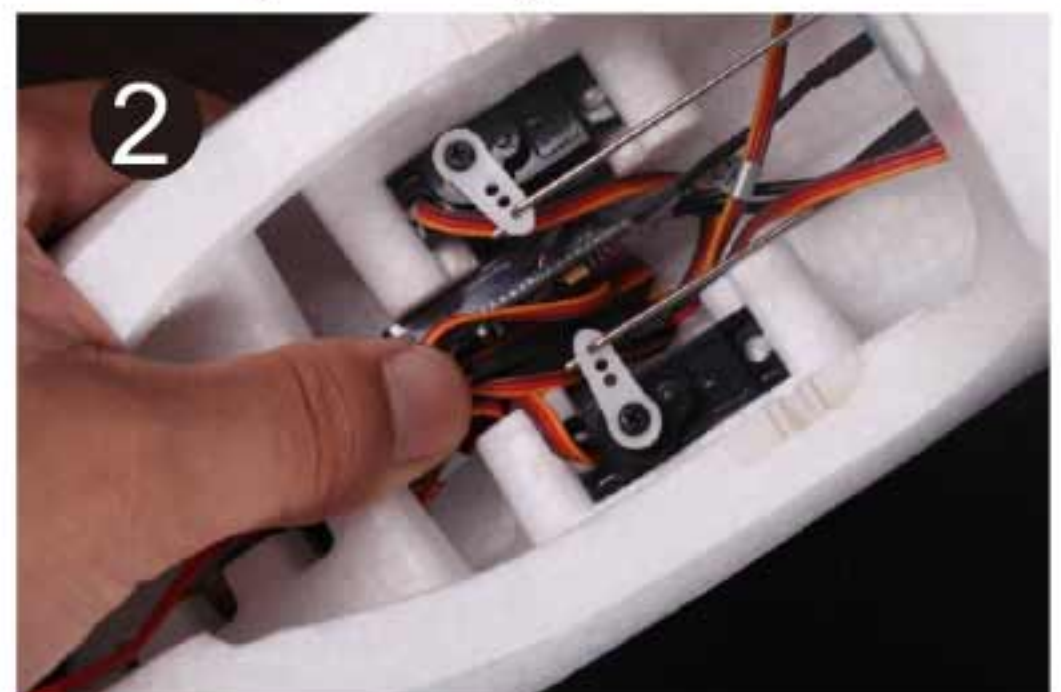

## Assemble the plane

3. Make sure all servo arms are fully vertical. If not, adjust the servo arm by using the trim function on your radio. **Note:** For computerized transmitters, use the servo/channel sub-trim feature to make each servo arm fully vertical.
4. The standard hole settings for linkage connections are shown by the black arrows in the diagram below. You can move the linkage to different hole positions to increase control surface travel and increase the aerobatics of the airplane.

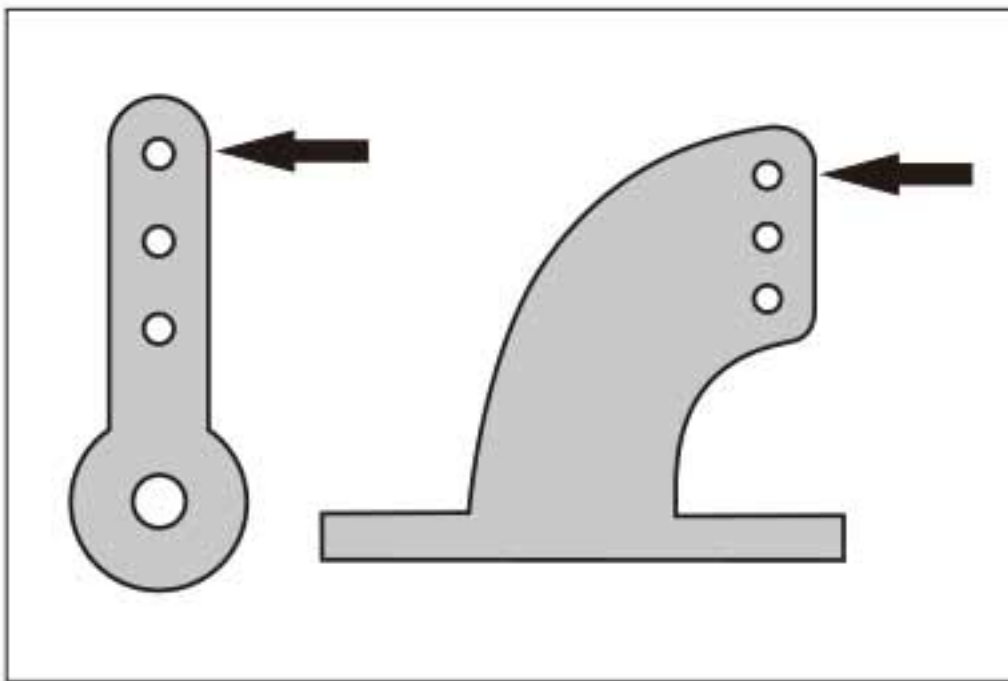

5. Snap the clevis into the surface control horn.



6. The provided piece of fuel tubing keeps the clevis closed during flight. Secure all the linkages the same way. **Note:** Do not over slide the securing tube or it will impede the movement of the surface control horn.



## Assemble the plane

### Install the main wing

1. The photo shows the wings tube .

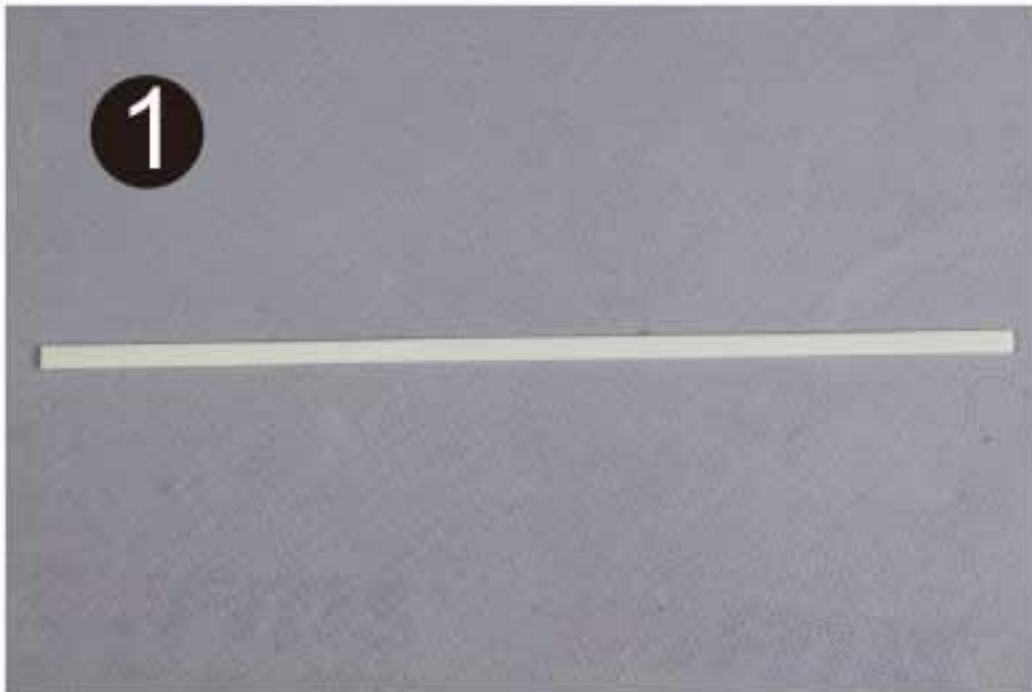

2. Inset the wing tube to one side of the wings, make sure the direction is right as photo shows.

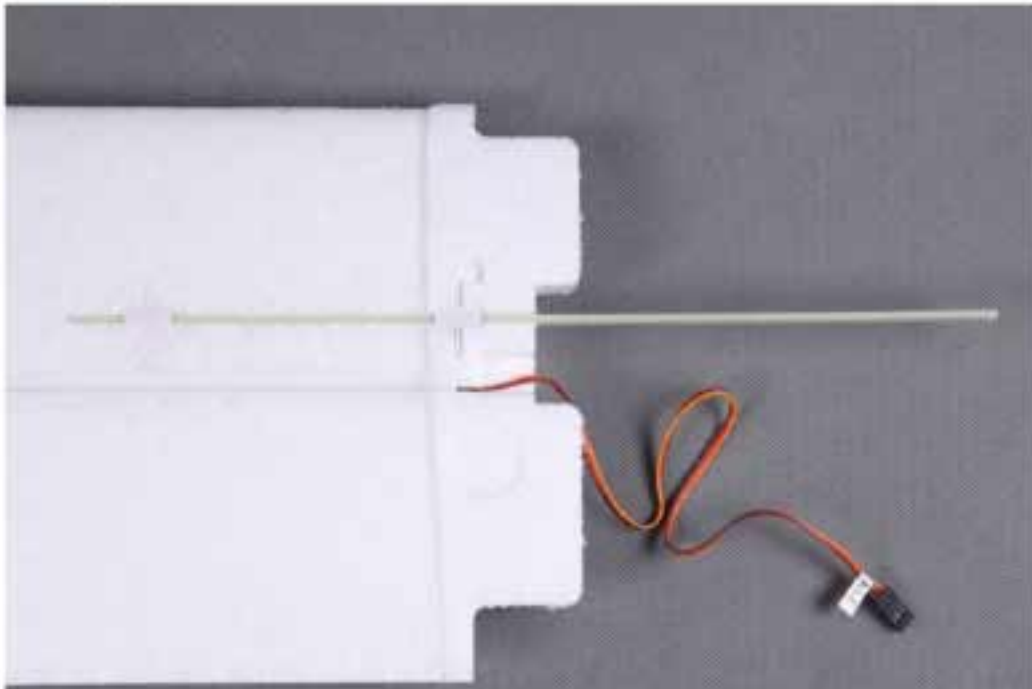

3. Slide the port side (Left) wing to the wing tube all the way to the wing saddle the same with the right panel, make sure it is fully fitted into place.



4. Be sure to pull the wire leads from the canopy hatch the same time to avoid any tangling to prevent the main wing from fully installation.



5. Connect the servo leads from the wing with the extension wires in the fuselage. Use the labels on the servo leads to match all four servos.

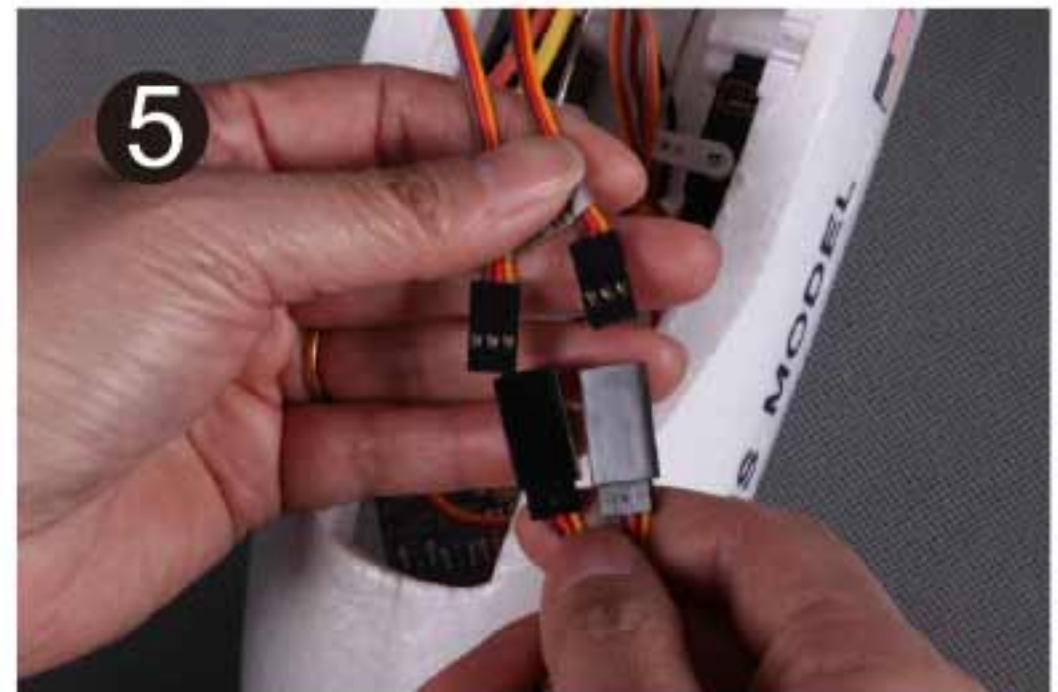

## Assemble the plane

### Install the main wing

6. 固锁主翼的棒子



8 当你要去下来主翼的时候要吧两个棒子用钩子拉出来。



7 固锁主翼把两根棒子安装在指定的位置。

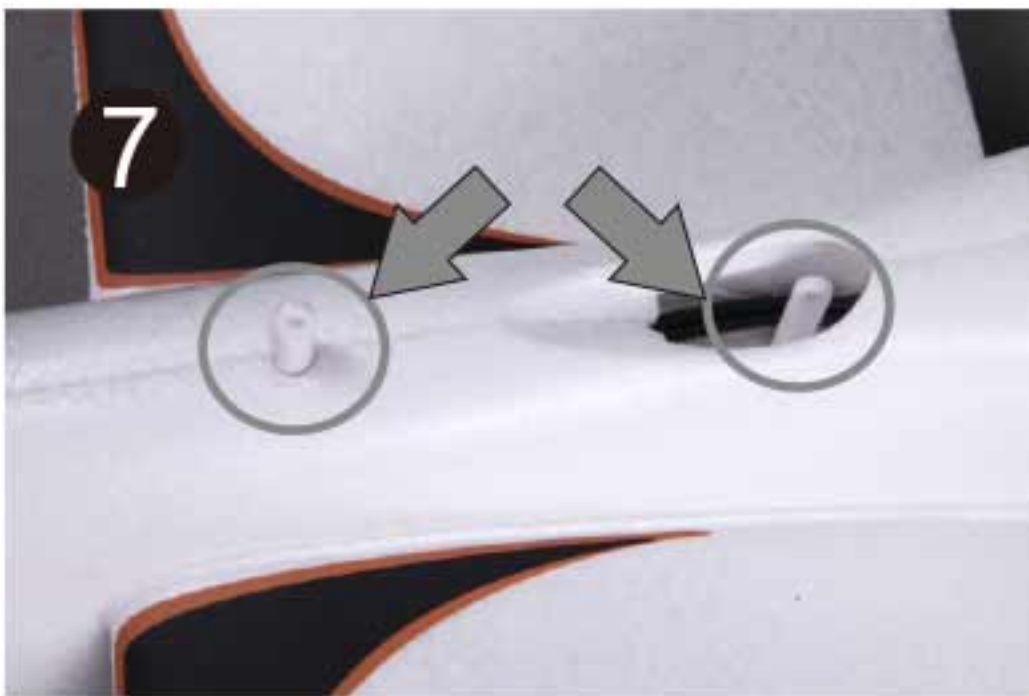

## *Disassemble the spinner*

### **Install the propeller set**

1. Keyed the propeller hub back plate onto the motor shaft fully. The plate will mate with the position nut on the shaft.



2. Install the propeller set to the motor shaft, the side with the maintenance mark faces the back of the plane.



3. Secure the bullet into place using the included machine screw.



## Assemble the plane

### Battery position

- Slide the battery all the way into the battery hatch with the power supply cable toward the rear end of the plane.  
**Note:** You may need to relocate the battery position to achieve the correct **CG** for your model.

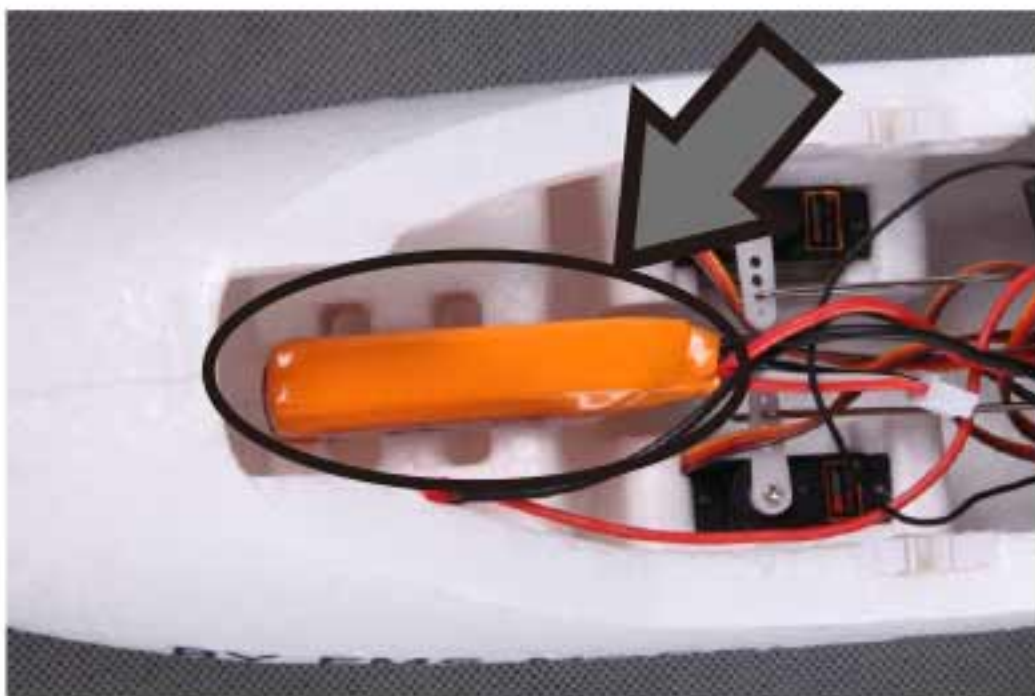

### The placement of the receiver

- Attach the receiver to the hatch in front of the servo using the hook and loop tape.

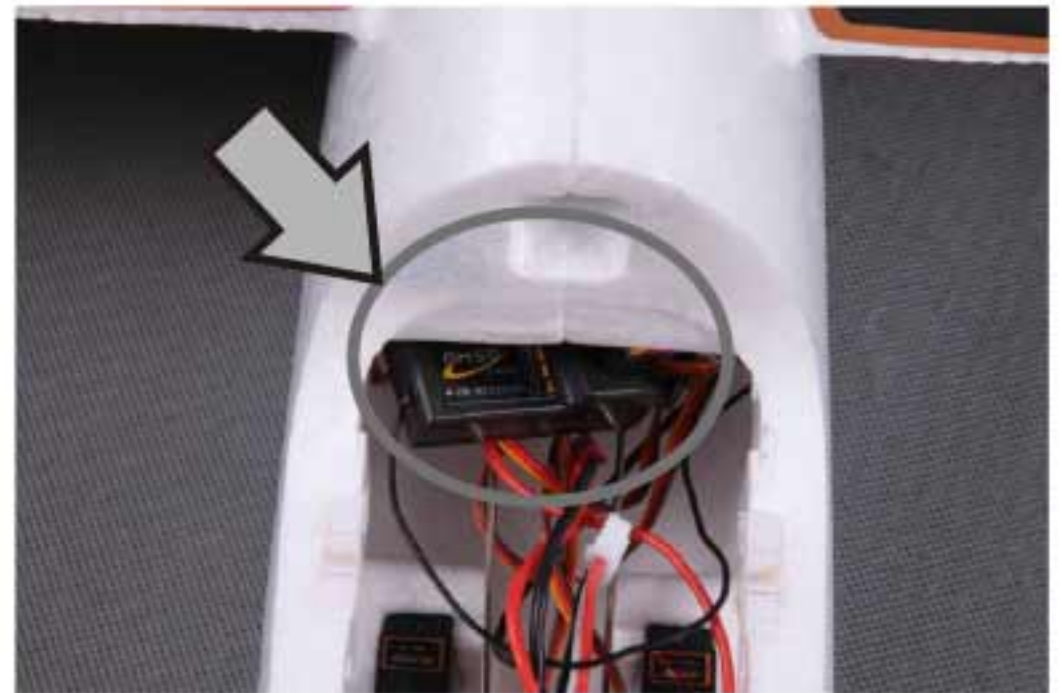

### The receiver connection

Attach right aileron to the elevator channel of your receiver. Left aileron goes to aileron channel of your receiver. You will need to activate the delta wing / elevon configuration of your transmitter. Attach the ESC connector to the throttle channel of the receiver.

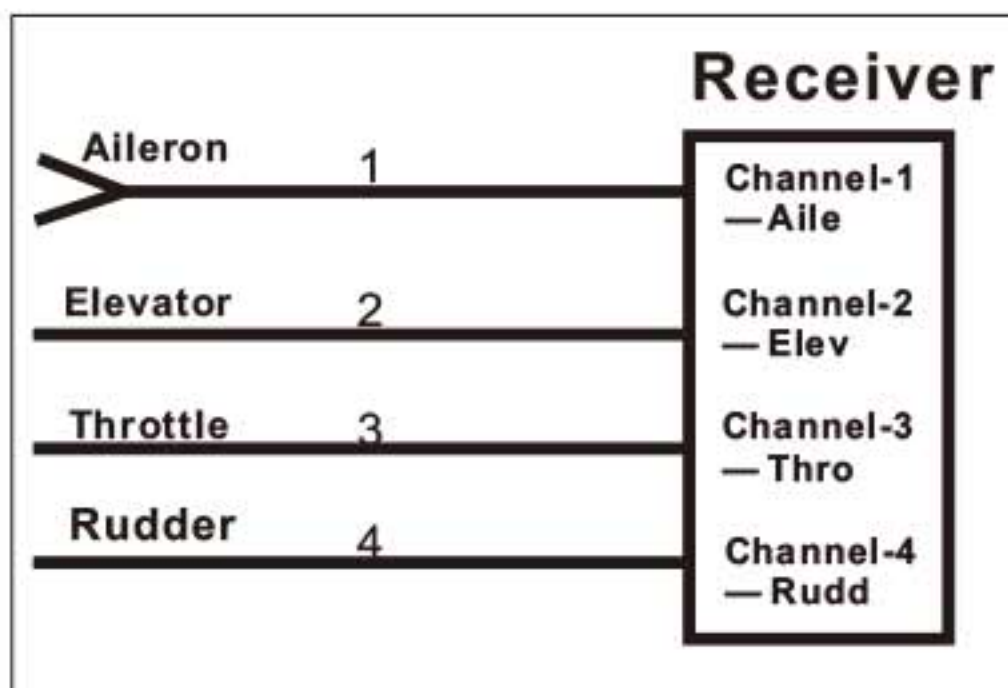

## Get your model ready to fly

### Important ESC information

1. The ESC included with the EASY TRAINER 1280 has a safe start. If the motor battery is connected to the ESC and the throttle stick is not in the low throttle or off position, the motor will not start until the throttle stick is moved to the low throttle or off position. Once the throttle stick is moved to the low throttle or off position, the motor will give a series of beeps. The started several beep with the same tune means the ESC is detect the cells of the battery. The counts of the same tune beeps equal the cells of the battery. The motor is now armed and will start when the throttle is moved.
2. The motor and ESC come already connected and the motor rotation should be correct. However, if you disconnected the ESC from the motor and when you reconnected it, the motor is rotating the wrong direction, reverse two of the three motor wires.
3. The motor has an optional brake setting. The ESC comes with the brake switched off and we recommended that the EASY TRAINER 1280 be flown with the brake on. However, the brake could be accidentally switched off if the motor battery is connected to the ESC while the throttle stick is set at full throttle. To switch the brake on, move the throttle stick to full throttle and plug in the motor battery. The motor will beep **one time**. Move the throttle stick to low throttle or the off position. The motor is ready to run and the brake will be switched off.
4. Battery Selection and Installation. We recommend the 7.4V 1300mAh20C Li-Po battery. If using another battery, the battery must be at least a 7.4V 1300mAh 20C battery. Your battery should be approximately the same capacity ,dimension and wight as the 7.4V 1300mAh 20C Li-Po battery to fit in the fuselage without changing the center of gravity too much.
5. The specification of the model list as fellow:

Wingspan	: 1280mm /50.4 in
Length	: 910mm /35.8 in
Weight	: 660g /23.3 oz
Servo	: 9g Servo x 4
Wing Area	: 21.4dm <sup>2</sup>
Wing Load	: 30.8g/dm <sup>2</sup>
Battery	: 7.4V 1300mAh Li-Po
The TX requires	: 4 Channel

## Get your model ready to fly

### The transmitter and model setup

Before getting started, bind your receiver with your transmitter. Please refer to your **Transmitter Manual** for proper operation.

**CAUTION:** To prevent personal injury, DO NOT install the propeller assembly onto the motor shaft while testing the control surfaces. DO NOT arm the ESC and do not turn on the transmitter until the **Transmitter Manual** instructs you to do so.

**Tips:** Make sure all control sticks on your radio are in the neutral position (rudder, elevator, ailerons) and the throttle in the OFF position. Make sure both ailerons move up and down (travel) the same amount. This model tracks well when the left and right ailerons travel the same amount in response to the control stick.

1. Move the controls on the transmitter to make sure aircraft control surface move correctly. Or you have to reverse the corresponding switch on the TX front panel mechanically. See diagrams below.

	Bank Left		Aileron
	Bank Right		
	Climb		Elevator
	Descend		
	Yaw Left		Rudder
	Yaw Right		



## Get your model ready to fly

1. Align the elevator and rudder surface with the wing root by turning the clevis clockwise and counterclockwise on the linkage, carefully open the clevis fork and put the clevis pin in the desired hole of the control horn. Trim the aileron to correct any misalignment.

**Note:** Please secure the clevis with provided piece of tube after the alignment of the surface is completed.

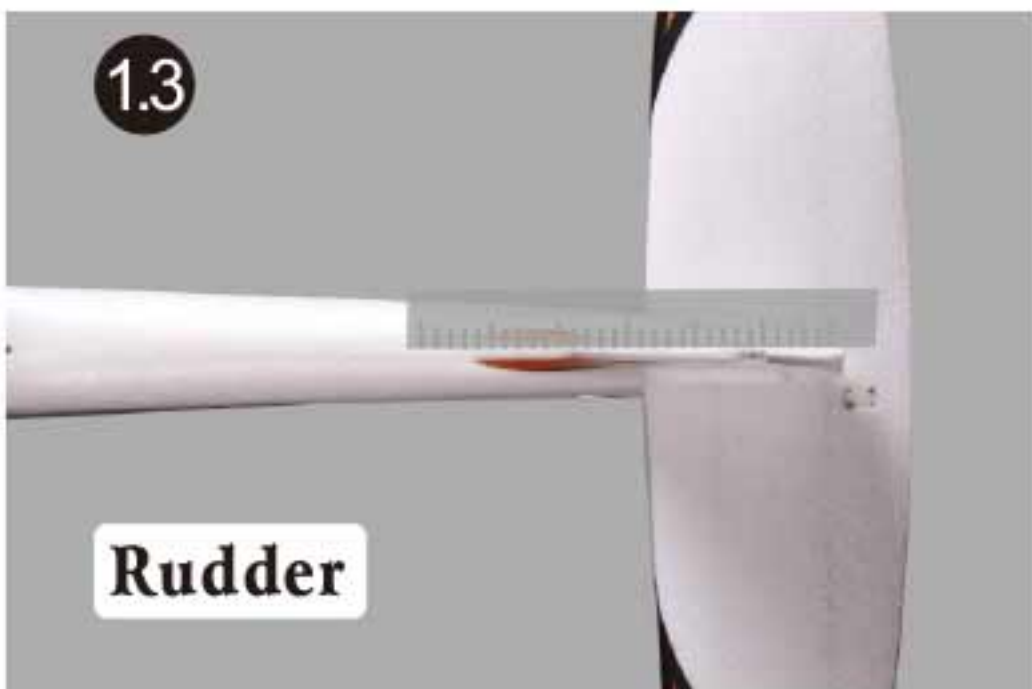

## Get your model ready to fly

### Check the motor rotating direction

1. Caution: Do not touch or do not close to the propeller while testing the rotating direction to avoid any body or property injury. The motor should rotate clockwise when viewing the plane from the rear.



### Flight control

For smooth control of your aircraft, always make small control moves. All directions are described as if you were sitting in the aircraft.

#### Tips:

1. Flying faster and slower: When your aircraft is stable in the air, push the throttle stick up to make the aircraft go faster, and pull the throttle stick back to slow down. The aircraft will climb when the throttle is increased.
2. Bank right and left: Move the aileron stick right to make the aircraft bank right and move the aileron stick left to bank left.
3. Elevator up and down: Push the elevator stick forward to make the aircraft go down and pull the elevator stick back to go up.

### Install the canopy

1. Install the canopy as the photos show.



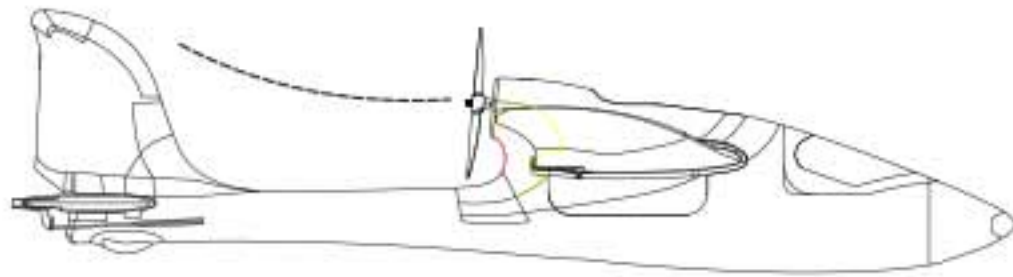

**Throttle up to fly faster**

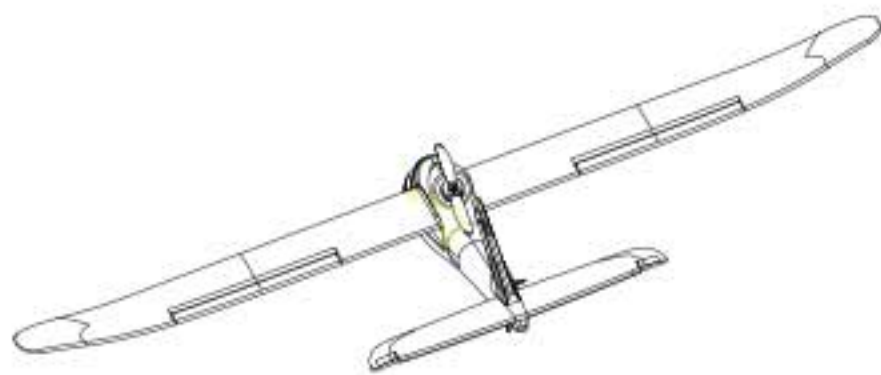
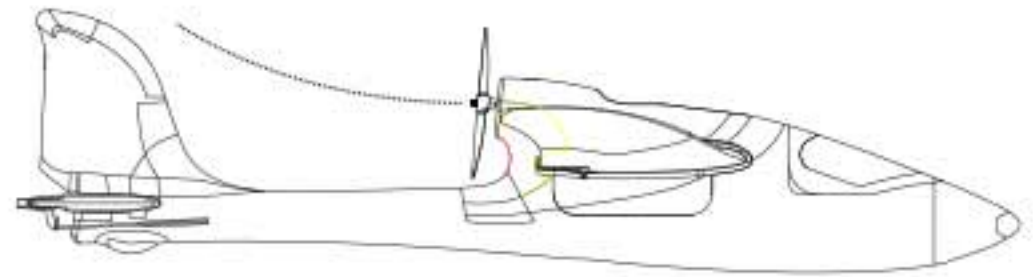

**Aileron: Bank Left**

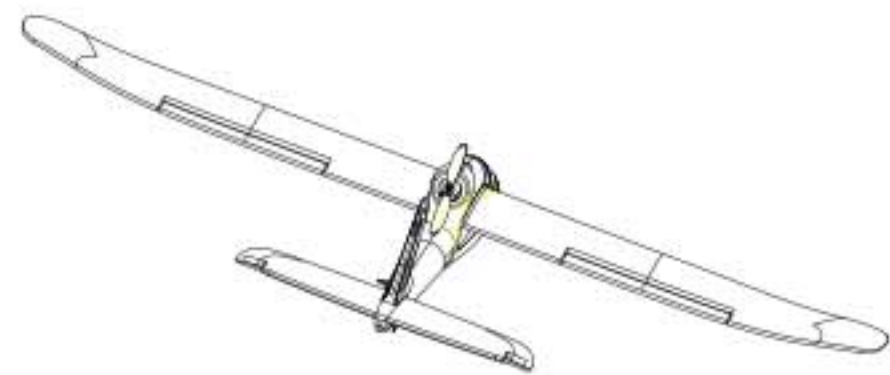

**Bank Right**

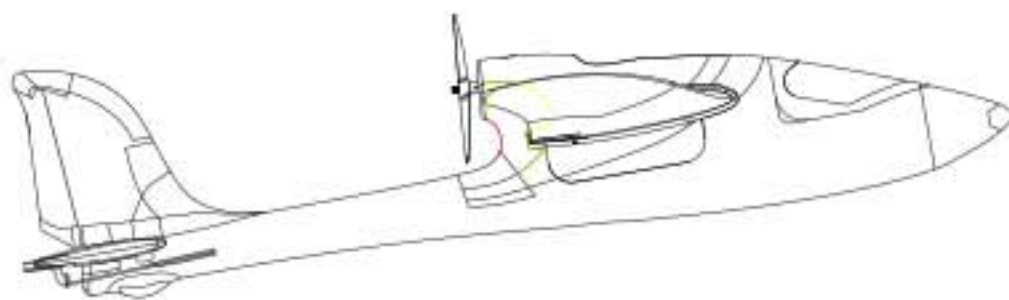

**Elevator: Climb**

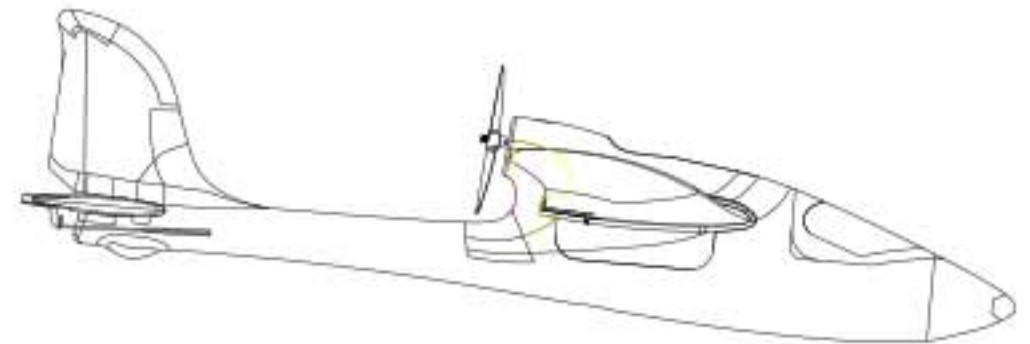

**Descend**



**Rudder: Yaw Left**



**Yaw Right**

### Check the C.G. (Center of Gravity)

#### Center of Gravity

When balancing your model, adjust the motor battery as necessary so the model is level or slightly nose down. This is the correct balance point for your model. After the first flights, The **CG** position can be adjusted for your personal preference.

1. The recommended Center of Gravity (**CG**) location for your model is **(70mm/ 2.75in)** back from the leading edge of the top main wing as shown with the battery pack installed. Mark the location of the **CG** on top of the wing.

2. When balancing your model, support the plane inverted at the marks made on the top of the main wing with your fingers or a commercially available balancing stand. This is the correct balance point for your model, Make sure the model is assembled and ready for flight before balancing.

**Note:** Always balance the plane with the retracts down.



## ***Before the model flying***

### **Find a suitable flying site**

Find a flying site clear of buildings, trees, power lines and other obstructions. Until you know how much area will be required and have mastered flying your plane in confined spaces, a site at least the size of two to three football fields should be adequate— a flying field specifically for R/C planes is best. Never fly near people— especially children who can wander unpredictably.

### **Perform the range check of your plane**

As a precaution, an operational ground range test should be performed before the first flight each time you go out. Performing a range test is a good way to detect problems that could cause loss of control such as low batteries, defective or damaged radio components or radio interference. This usually requires an assistant and should be done at the actual flying site you will be using.

First turn on the transmitter, then install the fully-charged battery into the fuselage. Connect the battery and install the hatch.

Remember, use care not to bump the throttle stick. Otherwise, the propeller will turn and possibly cause damage or injury.

**Note:** Please refer to your **Transmitter Manual** that come with your radio control system to perform a ground range check. If the controls aren't working correctly or if anything seems wrong, don't fly the model until you find and correct the problem. Make certain all the servo wires are securely connected to the receiver and the transmitter batteries are in good connection.

### **Monitor your flight time**

Monitor and limit your flight time use a timer (such as one on a wrist watch or in your transmitter if yours has one). When the batteries are getting low you will usually notice a performance drop before the ESC cuts off motor power, so when the plane starts flying slower you should land. Often (but not always), power can be briefly restored after the motor cuts off by holding the throttle stick all the way down for a few seconds.

To avoid an unexpected dead-stick landing on your first flight, set your timer to a conservative 4 minutes. When your alarm sounds you should land right away.

### **Take off**

The plane can only take off by the hand launch due to the abandoned landing gear design. To hand launch the Swift, hold the finger grips on the underside of the airplane. Give a firm throw directly into the wind slightly up (5-10 degrees above the horizon) with the throttle all the way down and the propeller not spinning. After release, when the propeller is clear of your hands, throttle up to climb out.

**Warning:** Do not to input the throttle while you grip the plane in your hand to avoid any body injuries due to the highly rotate parts of the plane.

### **Flying**

Always choose a wide-open space for flying your plane. It is ideal for you to fly at a sanctioned flying field. If you are not flying at an approved site, always avoid flying near houses, trees, wires and buildings. You should also be careful to avoid flying in areas where there are many people, such as busy parks, schoolyards, or soccer fields. Consult laws and ordinances be for choosing a location to fly your aircraft.

### **Landing**

Land the model when you hear the motor pulsing (LVC) or if you notice a reduction in power. If using a transmitter with a timer, set the timer so you have enough flight time to make several landing approaches.

Recharge the battery and repair the model as needed. The model's nose wheel and bottom fin skids let the model land on the hard surfaces when needed (which may damage the propeller). Align model directly into the wind and fly down to the ground. Fly the airplane down to the ground using 1/4-1/3 throttle to keep enough energy for proper flare. Before the model touches down, always fully decrease throttle to avoid damage the propeller or other components.

### **Maintenance**

The Swift is made from PA and polythene, repairs to the foam can be made using virtually any adhesive (hot glue, regular CA, epoxy, etc). When parts are not repairable, see the Spare Parts List for ordering by Item number.

Always check to make sure the screw for the control horns specially the screws related to the highly rotated components are firmly grabbed into place (The bullet of the propeller adaptor, the screws hold the motor into place).

## Troubleshooting

Problem	Possible Cause	Solution
Aircraft will not respond to the throttle but responds to other controls.	ESC is not armed. Throttle channel is reversed.	Lower throttle stick and throttle trim to lowest settings. Reverse throttle channel on transmitter.
Extra propeller noise or extra Vibration.	Damaged spinner, propeller, motor or motor mount. Loose propeller and spinner parts. Propeller installed backwards.	Replaced damaged parts. Tighten parts for propeller adapter, propeller and spinner.
Reduced flight time or aircraft underpowered.	Flight battery charge is low. Propeller installed backward. Flight battery damaged.	Remove and install propeller correctly. Completely recharge Flight battery. Remove and install propeller correctly. Replace flight battery and obey flight battery instructions.
Control surface does not move, or is slow to respond to control inputs.	Control surface, control horn, linkage or servo damage, Wire damaged or connections loose.	Replace or repair damaged parts and adjust controls. Do a check of connections for loose wiring.
Control reversed.	Channels need be reversed in the transmitter.	Do the Control Direction Test and adjust controls for aircraft and transmitter.
Motor loses power. Motor power pulses then motor loses power.	Damage to motor, or battery. Lose of power to aircraft. ESC uses default soft Low Voltage Cutoff(LVC).	Do a check of batteries, transmitter, receiver, ESC, motor and wiring for damage (replace as needed). Land aircraft immediately and Recharge flight battery.
LED on receiver flashes slowly.	Power lose to receiver.	Check connection from ESC to receiver. Check servos for damage. Check linkages for binding.

# AMA

If you are not already a member of the AMA, please join, The AMA is the governing body of model aviation and membership provided liability insurance coverage, protects modelers' rights and interests and is required to fly at most R/C sites.

## Academy of Model Aeronautics

5151 East Memorial Drive

Muncie, IN 47302-9252

Ph.(800)435-9262

Fax(765)741-0057

Or via the Internet at: <http://www.modelaircraft.org>



## Academy of Model Aeronautics National Model Aircraft Safety Code Effective January 1, 2011

- A. GENERAL:** A model aircraft is a non-human-carrying aircraft capable of sustained flight in the atmosphere. It may not exceed limitations of this code and is intended exclusively for sport, recreation and/or competition.  
All model flights must be conducted in accordance with this safety code and any additional rules specific to the flying site.
1. Model aircraft will not be flown:
    - (a) In a careless or reckless manner.
    - (b) At a location where model aircraft activities are prohibited.
  2. Model aircraft pilots will:
    - (a) Yield the right of way to all man carrying aircraft.
    - (b) See and avoid all aircraft and a spotter must be used when appropriate.  
(AMA Document #540-D-See and Avoid Guidance.)
    - (c) Not fly higher than approximately 400 feet above ground level within three (3) miles of an airport, without notifying the airport operator.
    - (d) Not interfere with operations and traffic patterns at any airport, heliport or seaplane base except where there is a mixed use agreement.
    - (e) Ensure the aircraft is identified with the name and address or AMA number of the owner on the inside or affixed to the outside of the model aircraft.  
(This does not apply to model aircraft flown indoors).
    - (f) Not operate aircraft with metal-blade propellers or with gaseous boosts except for helicopters operated under the provisions of AMA Document #555.
    - (g) Not operate model aircraft while under the influence of alcohol or while using any drug which could adversely affect the pilot's ability to safely control the model.
    - (h) Not operate model aircraft carrying pyrotechnic devices which explode or burn, or any device which propels a projectile or drops any object that creates a hazard to persons or property.



## AMA

### Exceptions:

- ◆ Free Flight fuses or devices that burn producing smoke and are securely attached to the model aircraft during flight.
  - ◆ Officially designated AMA Air Show Teams (AST) are authorized to use devices and practices as defined within the Team AMA Program Document (AMA Document #718).
3. Model aircraft will not be flown in AMA sanctioned events, air shows or model demonstrations unless:
- (a) The aircraft, control system and pilot skills have successfully demonstrated all maneuvers intended or anticipated prior to the specific event.
  - (b) An inexperienced pilot is assisted by an experienced pilot.
4. When and where required by rule, helmets must be properly worn and fastened. They must be OSHA, DOT, ANSI, SNELL or NOCSAE approved or comply with comparable standards.

### B. RADIO CONTROL (RC)

1. All pilots shall avoid flying directly over unprotected people, vessels, vehicles or structures and shall avoid endangerment of life and property of others.
2. A successful radio equipment ground-range check in accordance with manufacturer's recommendations will be completed before the first flight of a new or repaired model aircraft.
3. RC model aircraft must use the radio-control frequencies currently allowed by the Federal Communications Commission (FCC). Only individuals properly licensed by the FCC are authorized to operate equipment on Amateur Band frequencies.
4. RC model aircraft will not operate within three (3) miles of any pre-existing flying site without a frequency-management agreement (AMA Documents #922-Testing for RF Interference; #923- Frequency Management Agreement)
5. With the exception of events flown under official AMA Competition Regulations, excluding takeoff and landing, no powered model may be flown outdoors closer than 25 feet to any individual, except for the pilot and the pilot's helper(s) located at the flight line.
6. Under no circumstances may a pilot or other person touch a model aircraft in flight while it is still under power, except to divert it from striking an individual. This does not apply to model aircraft flown indoors.
7. RC night flying requires a lighting system providing the pilot with a clear view of the model's attitude and orientation at all times.
8. The pilot of a RC model aircraft shall:
  - (a) Maintain control during the entire flight, maintaining visual contact without enhancement other than by corrective lenses prescribed for the pilot.
  - (b) Fly using the assistance of a camera or First-Person View (FPV) only in accordance with the procedures outlined in AMA Document #550.

### C. FREE FLIGHT

1. Must be at least 100 feet downwind of spectators and automobile parking when the model aircraft is launched.
2. Launch area must be clear of all individuals except mechanics, officials, and other fliers.
3. An effective device will be used to extinguish any fuse on the model aircraft after the fuse has completed its function.



Email:[info@fmsmodel.com](mailto:info@fmsmodel.com)  
[Http://www.fmsmodel.com](http://www.fmsmodel.com)

MADE IN CHINA