

User Manual

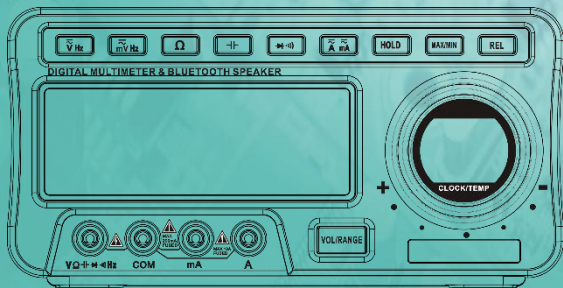

LIMITED WARRANTY AND LIMITATION OF LIABILITY

Customers enjoy one-year warranty from the date of purchase.

This warranty does not cover fuses, disposable batteries, damage from misuse accident, neglect, alteration, contamination, or abnormal conditions of operation or handling, including failures caused by use outside of the product's specifications, or normal wear and tear of mechanical components.

Contents

Title Page

Instruction.....	1
Safety Information.....	1
Instrument Overview.....	3
LCD Display.....	3
Function Buttons.....	6
Rotary Switch.....	9
Input Terminals.....	10
Measurement Instruction.....	11
Measure AC/DC Voltage.....	11
Measure AC/DC Current.....	11
Measure Resistance.....	12
Test Continuity.....	13
Test Diodes.....	13
Measure Capacitance.....	14
Measure Frequency/Duty Cycle.....	15
Clock Setting.....	15
Alarm Clock Setting.....	16
Bluetooth Connection.....	16

Auto Standby.....	17
Charge and Replace the Batteries.....	17
Replace the Fuses.....	18
Maintenance.....	18
Clean the Product.....	18
Specifications.....	19
General Specifications.....	19
Mechanical Specifications.....	19
Environmental Specifications.....	20
Electrical Specifications.....	21
Bluetooth Specifications.....	24

Introduction

This product is a lithium battery-powered, true RMS, auto-range multi-function digital multimeter with 19999 counts LCD display and adjustable backlight brightness. It is equipped with clock, alarm clock, Bluetooth to play music, temperature display.

Safety Information

To avoid possible electrical shock, fire, or personal injury, please read all safety information before you use the product. Please use the product only as specified, or the protection supplied by the product can be compromised.

- Examine the case before you use the product. Look for cracks or missing plastic. Carefully look at the insulation around the terminals.
- The measurement must be made with correct input terminals and functions and within the allowable measuring range.



- Do not use the product around explosive gas, vapor, or in damp or wet environments.
- Keep fingers behind the finger guards on the probes.
- When the product has already been connected to the line being measured, do NOT touch the input terminal that is not in service.
- Disconnect the test leads from the circuit before changing the mode.
- When the voltage to be measured exceeds 36V DC or 25V AC, the operator shall be careful enough to avoid electric shock.
- Misuse of mode or range can lead to hazards, be cautious. "OL" will be shown on the display when the input is out of range.
- Low level of a battery will result in incorrect readings. Change the batteries when battery level is low. Do not make measurements when the battery door is not properly placed.

Instrument Overview

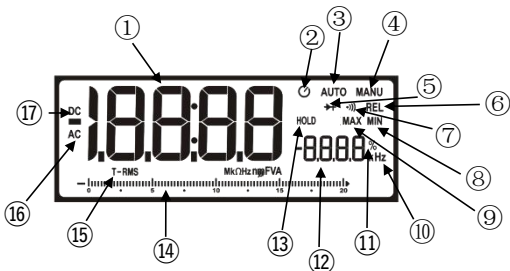
Main LCD Display



①	1.88.88	Main display
②		Auto standby
③	AUTO	Auto range
④	MANU	Manual range
⑤		Diode test
⑥	REL	Relative value test

⑦		Continuity test
⑧	MIN	Display shows maximum reading.
⑨	MAX	Display shows minimum reading.
⑩	Hz	Frequency test. (Hertz)
⑪	%	Duty cycle test
⑫		Vice Display
⑬	HOLD	Display hold present reading.
⑭		Analog bar graph.
⑮	T-RMS	The product measures both sinusoidal and nonsinusoidal ac waveforms accurately.
⑯	AC	Alternating current
⑰	DC	Direct current

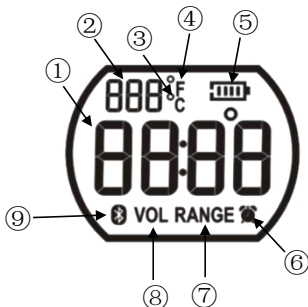

Vice Display





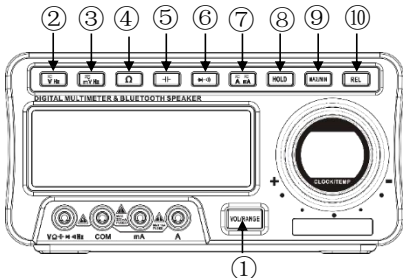



①		Main display for data
②		Vice display for data
③	°C	Regular temperature (Celsius)
④	°F	Regular temperature(Fahrenheit)
⑤		Battery power
⑥		Alarm clock
⑦	RANGE	Range select
⑧	VOL	Volume control
⑨		Bluetooth connection

Function Buttons



①	Press this button to select the multimeter's range or control the audio playback volume.
②	Press this button  to enter AC and DC voltage and frequency measurement mode. AC voltage: $\leq 750V$. The main display shows the voltage and the secondary display shows the frequency. DC voltage: $\leq 1000V$.
③	Press this button  to enter the AC and DC millivolt voltage and frequency measurement mode. DC voltage: $\leq 199.99mV$. AC voltage: $\leq 199.99mV$.
④	Press this button  to enter the resistance measurement mode. Resistance: $\leq 199.99M\Omega$.

Function Buttons

⑤	Press this button  to enter the capacitance measurement mode. Capacitor: $\leq 100\text{mF}$.
⑥	Press this button  to enter the diode/on-off measurement mode. Continuity: The buzzer sounds when it is less than 50Ω . Diode: more than 3V will display "  "
⑦	Press this button  to enter AC and DC high current, AC and DC milliamp current measurement mode. DC high current: $\leq 19.999\text{A}$. AC high current: $\leq 19.999\text{A}$. DC mA current: $\leq 199.99\text{mA}$. AC mA current: $\leq 199.99\text{mA}$.
⑧	Press this button  to keep the current reading.
⑨	Press this button  to record the maximum value and minimum value. Long press to exit.
⑩	Press this button  to enter the relative value measurement mode.

Function Buttons

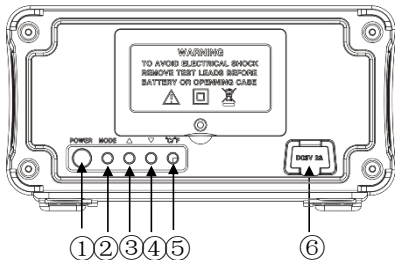

①	Power Button
②	Setting Button. Short press to enter the clock setting and long press to enter the alarm clock setting. Short press to enter the next setting after entering the setting mode, and long press to exit the setting mode. (In the standby mode, you cannot enter the setting mode. If you need to set it, please wake up and then make the relevant settings.)
③	Increase the screen brightness. In the setting mode, increase the clock/alarm setting value and select the alarm on/off.
④	Decrease the screen brightness. In the setting mode, decrease the clock/alarm setting value and select the alarm on/off.
⑤	Switch the Celsius/Fahrenheit of the regular temperature.
⑥	Charging power connector (maximum input DC5V 2A)

Rotary Switch

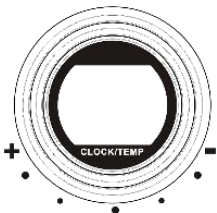

- When using the multimeter, press the “VOL/RANGE” button to go to the RANGE mode and rotate to select the corresponding range.
 - When using Bluetooth audio, press the “VOL/RANGE” button to go to VOL mode, rotate to control the playback volume.
 - When the alarm is ringing, rotate to turn off the alarm.
- Note:
- 1. When the multimeter is standby, the audio playback volume can only be controlled by the rotary switch.
 - 2. When charging or not placing the battery to play music, rotate to control the volume of 0-15 grades. When the battery is full or not charging, rotate to control the volume of 0-30 grades.

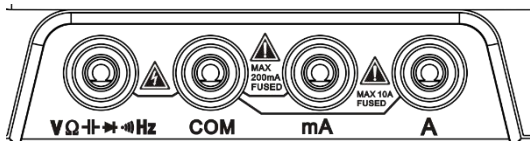

Input Terminals



A	Used for high current measurement ($\leq 19.999A$).
mA	Used for low current measurement ($\leq 199.99mA$)
COM	Common (return) terminal for all measurements.
VΩ⊖⊕⊚Hz	Input terminal for the measurements of: 1. AC/DC voltage 2. Resistance 3. Capacitance 4. Frequency 5. Continuity 7. Diode

Measurements Instruction

Measure AC/DC Voltage

1. Turn the rotary switch to  or , then choose AC or DC Voltage range.
2. Connect the black test lead to the COM Terminal and the red lead to the  Terminal.
3. Touch the probes to the correct test points of the circuit to measure the voltage.
4. Read the measured voltage on the display.

- Do not measure voltage that exceeds the extremes as indicated in the Specifications.
- Do not touch high voltage circuit during measurements.



Measure AC/DC Current

1. Turn the rotary switch to , then choose AC or DC Current range.
2. Connect the black test lead to the COM Terminal and the red test lead to the A ($\leq 19.999\text{A}$) or mA ($\leq 199.99\text{mA}$).

3. Press SEL to toggle between AC/DC.
4. Read the measured current on the display.

- Do not measure current that exceeds the extremes as indicated in the Specifications .
- Use the 19.999A range at the “A” terminal to test when you are measuring an unknown current. Then switch to the right terminal and the range regard to the value.
- Fobid testing voltage on this range, or the damage on meter or human body may happen. Please make sure knowing the ways to test current before testing.

Measure Resistance

1. Press  to switch to resistance range.
2. Connect the black test lead to the COM terminal and the test lead to the  terminal.
3. Use the probe pin to contact two sides of the resistance.
4. Read the measured resistance on the display.

- Disconnect circuit power and discharge all capacitors before you test resistance.
- Do not input voltage at this setting.

Test for Continuity

1. Press  to enter in continuity range.
2. Put the black test lead into COM terminal and the red test lead into $\text{V}\Omega\text{h}\mu\text{Hz}$ terminal. Use the probe pin to contact two sides of circuit to be tested .
3. The built-in beeper will beep when the resistance is lower than 50Ω , which indicates a short circuit.

- Do not input voltage at this setting.

Test Diodes

1. Press  twice to enter in diode range.
2. Put the black test lead into COM terminal and the red test lead into $\text{V}\Omega\text{h}\mu\text{Hz}$ terminal.
3. Contact the red pin with the positive pole and the black lead pin with the negative pole of the diode.
4. Read the forward bias voltage value on the display.

5. If the polarity of the test leads is reversed with diode polarity or the diode is broken, the display reading shows “OL”.



- Do not input voltage at this setting.
- Disconnect circuit power and discharge all capacitors before you test diode.



Measure Capacitance

1. Press  to enter in capacitance range.
2. Put the black test lead into COM terminal and the red test lead into VΩ+*~4Hz terminal.
3. Contact the red pin with the positive pole and the black lead pin with the negative pole of the diode.
4. Read the measured capacitance value on the display once the reading is stabilized.

- Disconnect circuit power and discharge all capacitors before you test capacitance.

Measure frequency and duty cycle.

1. Press  or  to enter in frequency range.
2. Put the black test lead into COM terminal and the red test lead into  terminal.
3. Touch the probes to the desired test points.
4. Read the measured frequency value on the display, read the duty cycle value at the vice display.

- Press  to enter in AC voltage and frequency range, test the frequency of AC voltage that beyond 36V.
- Press  to enter in the AC mV range, test the frequency of AC voltage that less than 36V.

Clock setting

Shortly press “MODE” to enter in clock setting mode, press “▲” and “▼” to set hour number when it is twinkling, and then press “MODE” again to set minute number the same way as hour setting. Long press “MODE” to quit.

Alarm clock setting

Long press “MODE” to enter in alarm clock mode, when the line shows alarm clock symbol and hour number begin twinkling, press “▲” and “▼” to set hour number and minute number. Shortly press “MODE” to turn on or off alarm clock. Long press “MODE” to quit.

Play music by linking BlueTooth

1. Press “POWER” to turn on BlueTooth, when the BlueTooth symbol start twinkling, turn on mobile’s BlueTooth to search it and click to link it. Warning voice ringing when it link successfully.

2. The warning voice “dongdong” prompt to disconnect BlueTooth.

- The BlueTooth will be disconnected when in setting mode, it will connect again when quit setting mode.
- BlueTooth function will be closed if long time no operation. Turn on it again to link it.

Auto standby

It will enter in standby mode if no operation in 15 minutes. At the time, main line display time and vice line display regular temperature and battery capacity, etc.

Please press “REL” to turn on it again when it had been turn off if you want to cancel auto standby. Auto standby canceled when buzzer warn 5 times.

Charge and replace battery

When it shows low battery and prompt by warn “dudu”. It should be charged or replaced battery. Before replacing battery, all measurement must be disconnected. Use screwdriver to open battery cover to replace battery and then activate new battery to turn on.

- Because the lithium battery protection circuit is set inside the product, you need to re-plug the USB battery after the battery is replaced to activate the new battery.
- Please disconnect all measuring cables before replacing the battery, otherwise there is a possibility of endangering personal safety.

Replace the fuse

When the fuse blows or fails, follow the steps below to replace the fuse:

1. Remove the test leads and turn off the power before replacing the fuse.
2. Unscrew the four screws securing the back cover on the back of the product and remove the back cover.
3. Remove the old fuse and replace it with a new one of the same type.
4. Replace the back cover and tighten the screws.

Maintenance

Except for battery and fuse replacement, do not attempt to repair the product or change the circuit unless you are qualified and have the appropriate calibration, performance testing, and service instructions.

Clean the Product

Wipe the product with a damp cloth and mild detergent. Do not use abrasives or solvents. Dirt or moisture in the terminals can affect readings.

*Remove the input signals before you clean the product.

Specifications

General Specifications	
Display (LCD)	19999 counts
Ranging	Auto/Manual
Material	ABS+TPE
Update rate	3 times/ second
True RMS	√
Data hold	√
Backlight	√
Low battery Indicated	√
Auto power off	√
Mechanical Specifications	
Dimension	200*135*105mm
Weight	895g (without batter)
Battery type	18650 Lithum battery * 2
Warrantly	One year

Environmental Specifications

Operating	Temperature	0~40°C
	Humidity	<75%
Storage	Temperature	-20~60°C
	Humidity	<80%

Electrical Specifications

<i>Function</i>	<i>Range</i>	<i>Resolution</i>	<i>Accuracy</i>
<i>DC voltage (V)</i>	1.9999V	0.0001V	$\pm(0.05\%+3)$
	19.999V	0.001V	
	199.99V	0.01V	
	1000.0V	0.1V	
<i>DC volatge (mV)</i>	19.999mV	0.001mV	$\pm(0.3\%+3)$
	199.99mV	0.01mV	
<i>AC voltage (V)</i>	1.9999V	0.0001V	$\pm(0.3\%+3)$
	19.999V	0.001V	
	199.99V	0.01V	
	750.0V	0.1V	
<i>AC voltage (mV)</i>	19.999mV	0.001mV	Attention: Turn off music playing when use mV range, otherwise the accuracy will be affected.
	199.99mV	0.01mV	

Function	Range	Resolution	Accuracy
DC current (A)	1.9999A	0.0001A	$\pm(0.5\%+30)$
	19.999A	0.001A	
DC current (mA)	19.999mA	0.001mA	$\pm(0.5\%+10)$
	199.99mA	0.01mA	
AC current (A)	1.9999A	0.0001A	$\pm(0.8\%+30)$
	19.999A	0.001A	
AC current (mA)	19.999mA	0.001mA	$\pm(0.8\%+10)$
	199.99mA	0.01mA	
Resistance	199.99 Ω	0.01 Ω	$\pm(0.5\%+3)$
	1.9999k Ω	0.0001k Ω	$\pm(0.2\%+3)$
	19.999k Ω	0.001k Ω	
	199.99k Ω	0.01k Ω	
	1.9999M Ω	0.0001M Ω	$\pm(1.0\%+3)$
	19.999M Ω	0.001M Ω	
	199.99M Ω	0.01M Ω	$\pm(5.0\%+5)$

Function	Range	Resolution	Accuracy
Capacitance	9.999nF	0.001nF	$\pm(5.0\%+20)$
	99.99nF	0.01nF	$\pm(2.0\%+5)$
	999.9nF	0.1nF	
	9.999 μ F	0.001 μ F	
	99.99 μ F	0.01 μ F	
	999.9 μ F	0.1 μ F	
	9.999mF	0.001mF	$\pm(5.0\%+5)$
Frequency	99.99Hz	0.01Hz	$\pm(0.1\%+2)$
	999.9Hz	0.1Hz	
	9.999kHz	0.001kHz	
	99.99kHz	0.01kHz	
	999.9kHz	0.1kHz	
	6.000MHz	0.001MHz	

Fuction	Range	Resolution	Accuarcy
Diode		√	
Continuity		√	

BlueTooth speaker technology parameters

BlueTooth version	V5.0
Transfer distance	$\leq 10\text{m}$
Rated power	2 x 4W RMS
Frequency response range	100Hz-18KHz
Distortion	$\leq 1\%$
Signal to noise ratio	$\geq 76\text{dB}$

