

80g道林纸, 双面单黑印刷, 骑马钉, 封面背面为空白页
成品尺寸: 70*100mm

封底

封面

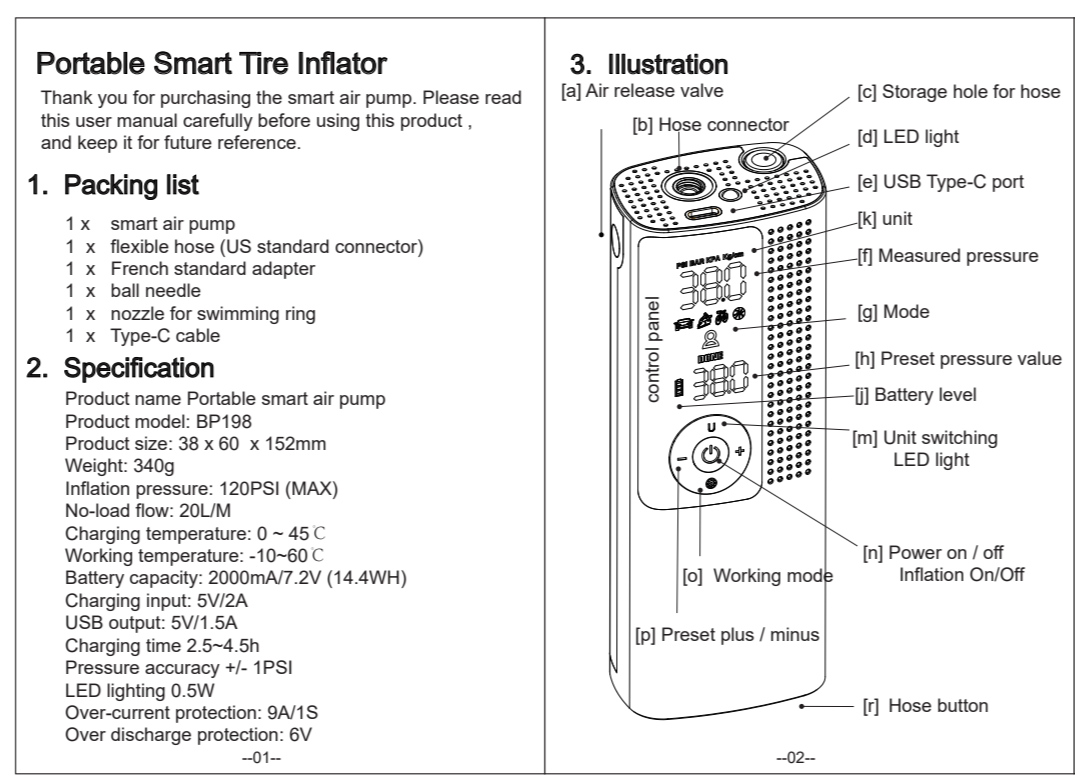
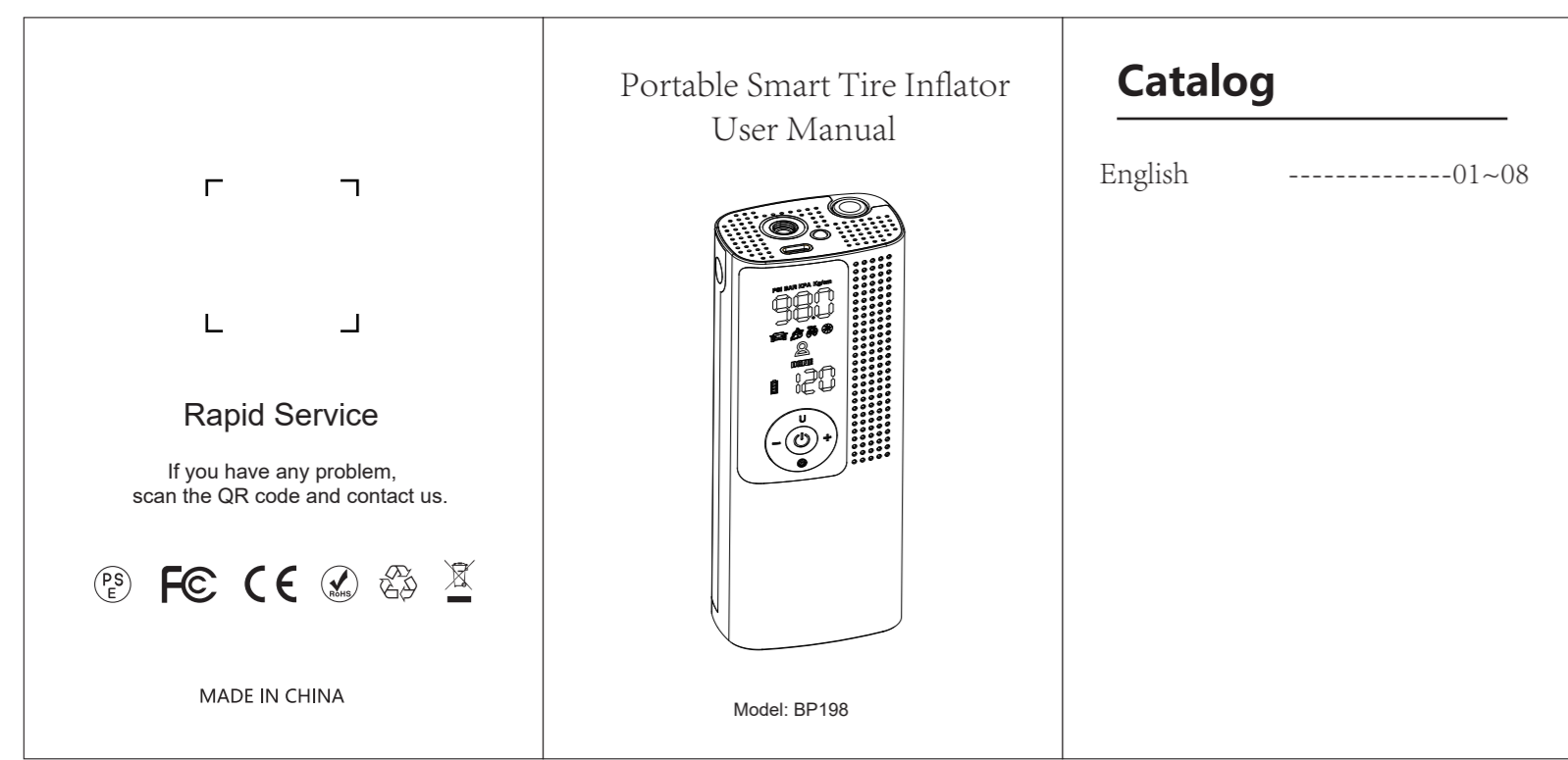

4. ATTENTION:
1) Do not leave during inflation.
2) Keep away from combustible and explosives.
3) Avoid contact with hot and cold objects.
4) Do not store the product in a place that is too cold or hot.
5) It is forbidden to use the product in an open or closed area where there is a fire or explosion risk.
6) Do not use the product if the battery is low.
7) Do not use the product if the battery is low.
8) Do not use the product if the battery is low.
9) Do not use the product if the battery is low.
10) Do not use the product if the battery is low.

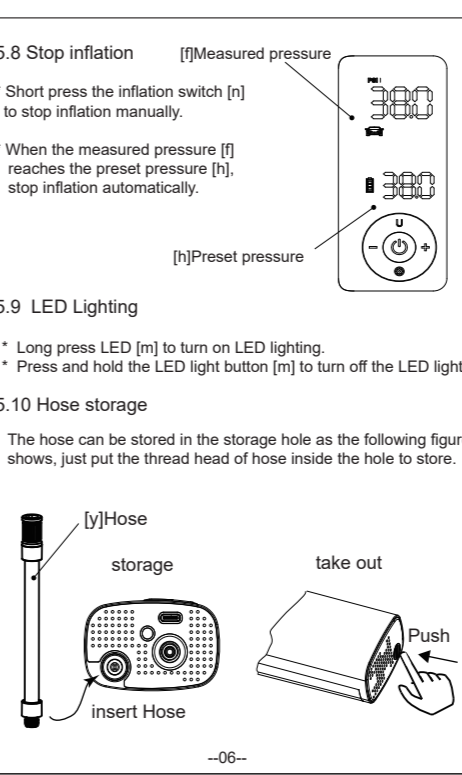
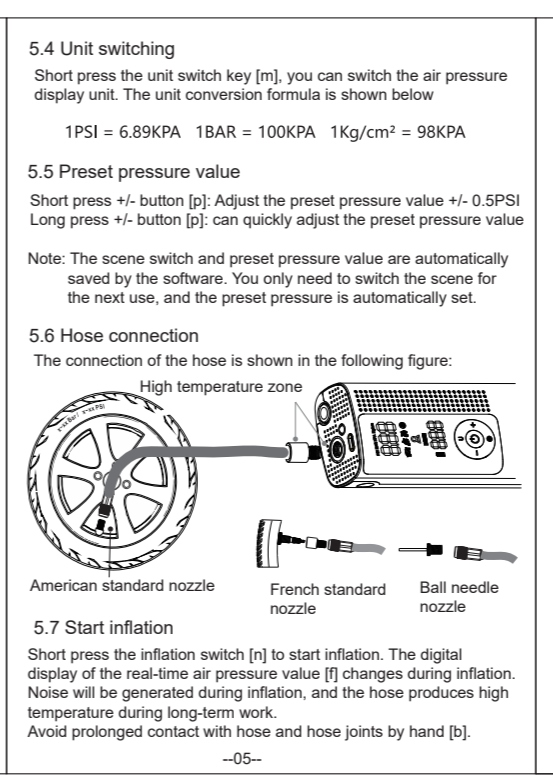
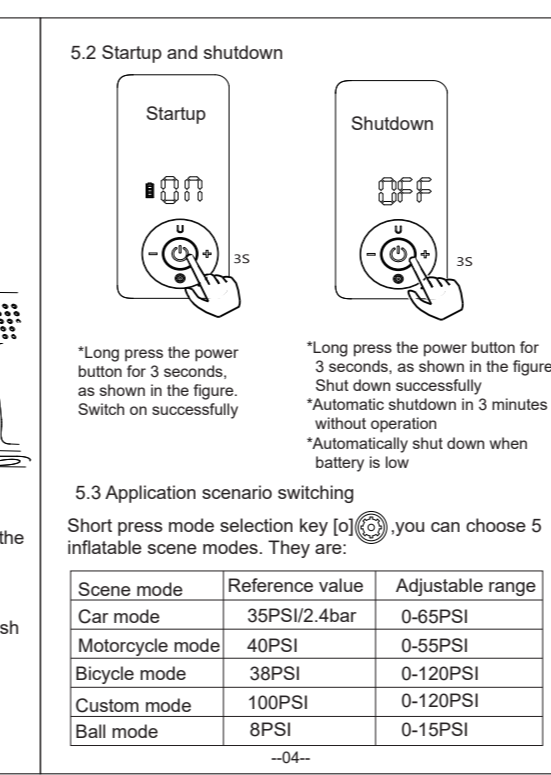

category	Type	Pressure value
bicycle	Street	18-30PSi
	10-16inch tire	30-45PSi
	20-30inch tire	38-55PSi
road bike		90-120PSi
motorcycle	motor / wheelbar / Moped	30-45PSi
Electric car		28-55PSi
car	car	2.2-2.8Bar
ball	Children's toy ball	3-6PSi
	baseball	7-9PSi
	Football	10-12PSi
	volleyball	4-6PSi
	Rugby	10-14PSi

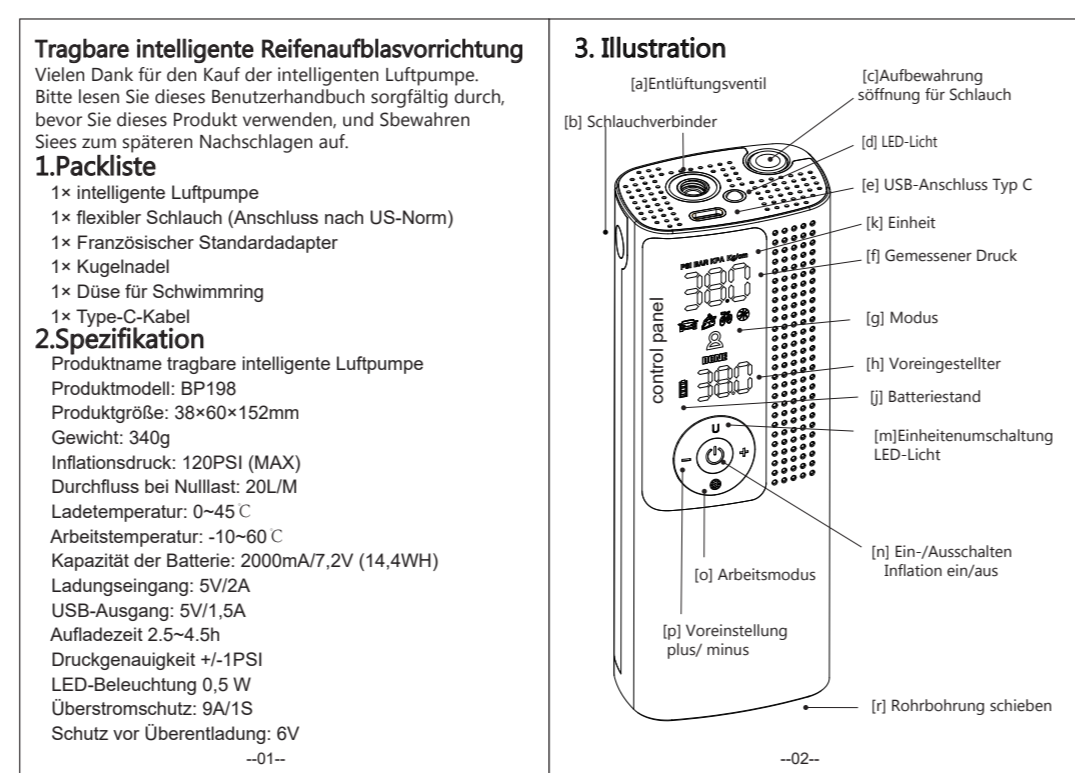
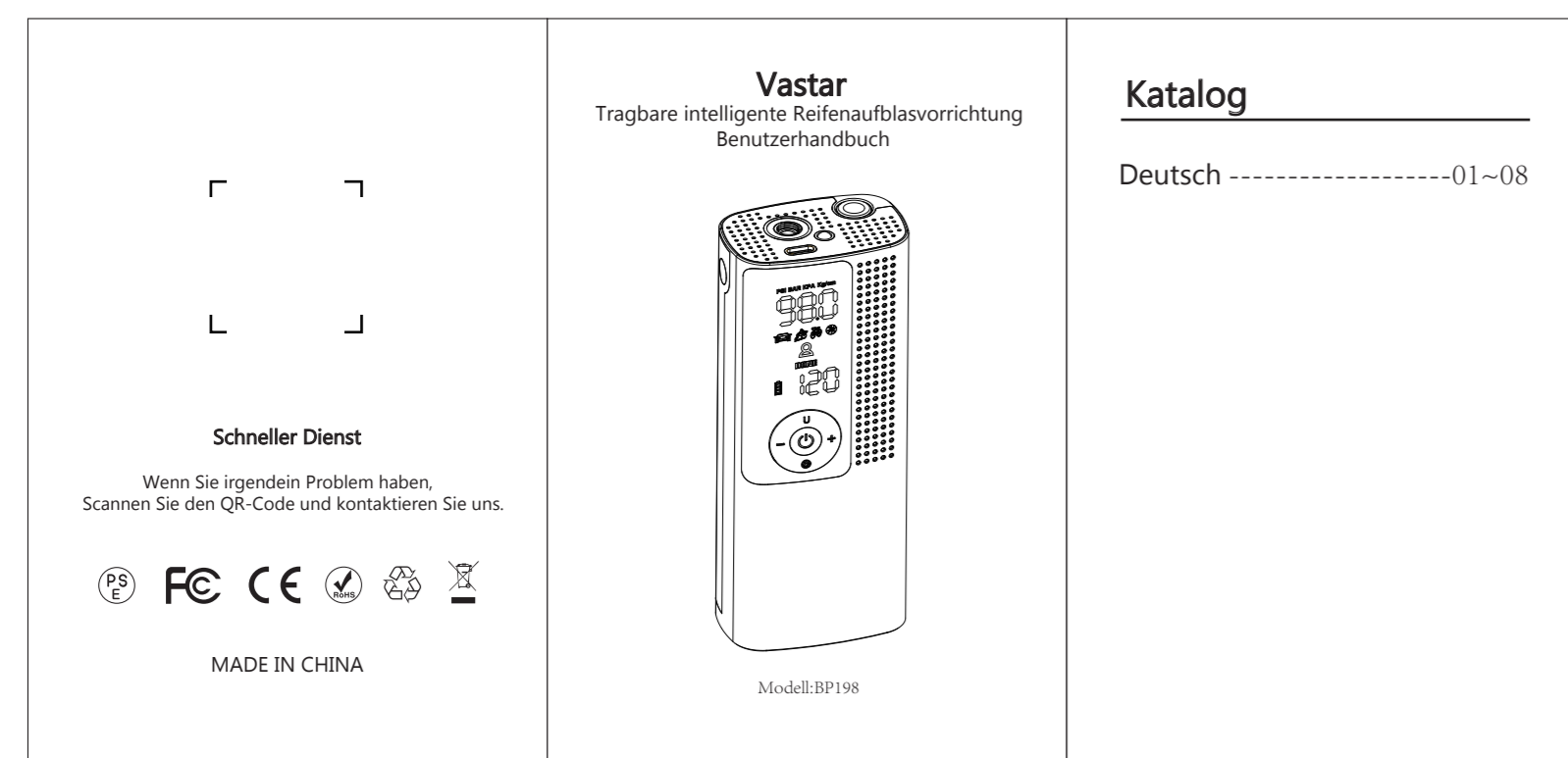

4.ACHTUNG:
1) Während der Inflation nicht verlassen.
2) Entfernen Sie sich von brennbaren und explosiven Stoffen fernhalten.
3) Vermeiden Sie Feuer, Hitze und Schläge.
4) Lagern Sie das Produkt nicht an einem Ort, der zu kalt oder zu heiß ist.
5) Es ist verboten, das Produkt in Feuer zu werfen oder es aufzutragen (nicht angeschlossen) für charging charging status: battery indicator flashes. Flashing red indicates low battery level. The product cannot be used during charging.
6) Do not use the product if the battery is low.
7) Do not use the product if the battery is low.
8) Do not use the product if the battery is low.
9) Do not use the product if the battery is low.
10) Do not use the product if the battery is low.

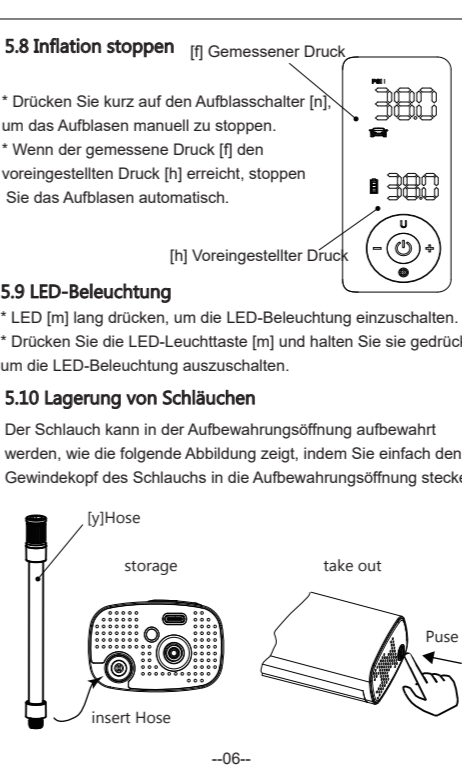
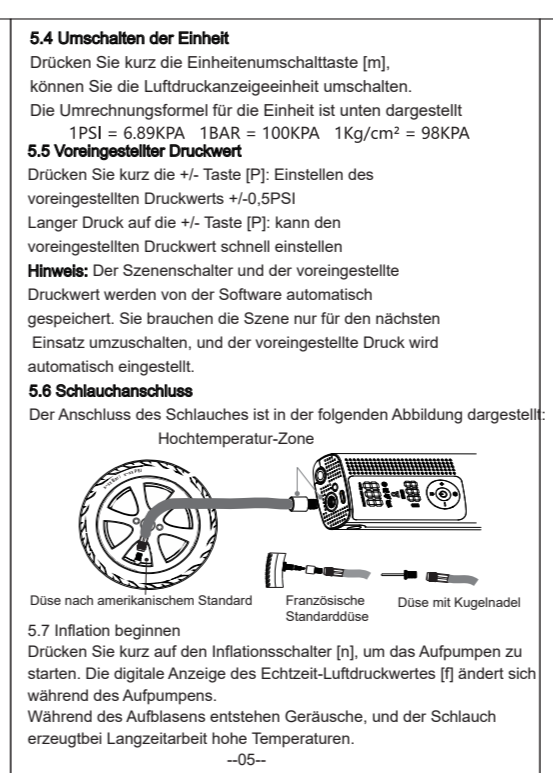
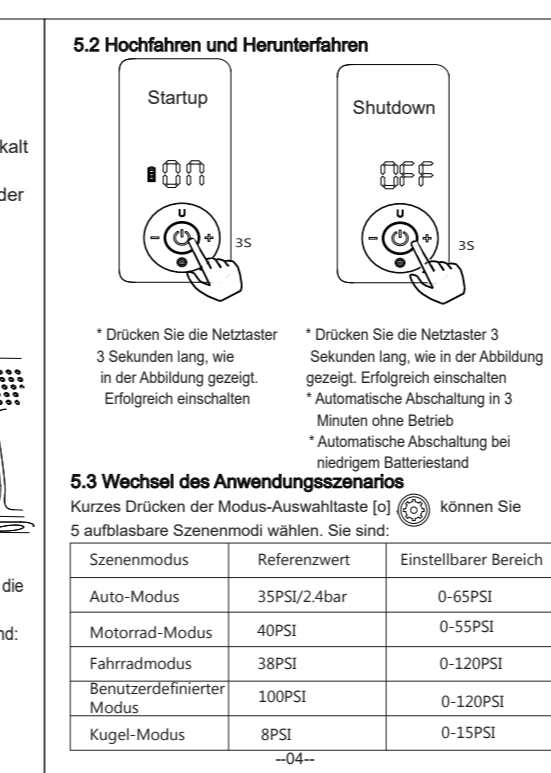

Kategorie	Typ	Druckwert
Fahrrad	Kontinental	18-30PSi
	10-16Zoll Reifen	30-45PSi
	20-30 Zoll-Reifen	38-55PSi
	Rad	90-120PSi
Motorrad/Moped		30-45PSi
Motorrad/ Elektroauto		28-55PSi
Auto	Auto	2.2-2.8Bar
Spielfußball für Kinder	3-6PSi	
Basketball	7-9PSi	
Fußball	10-12PSi	
Volleyball	4-6PSi	
Rugby	10-14PSi	

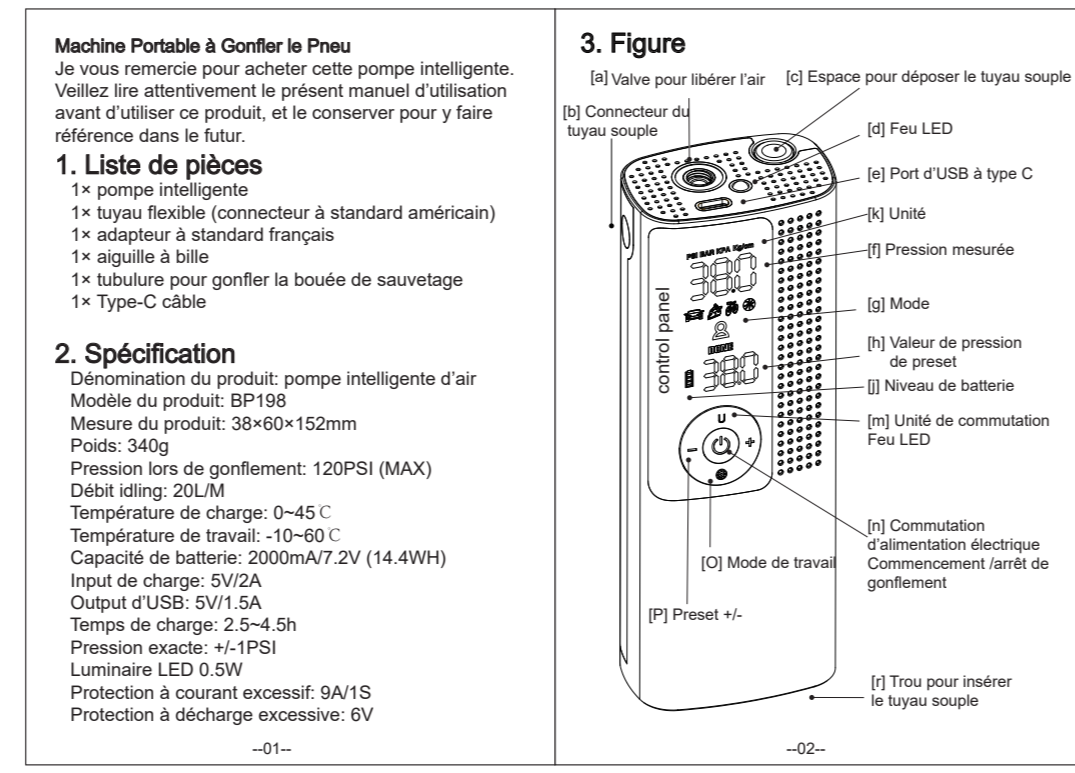
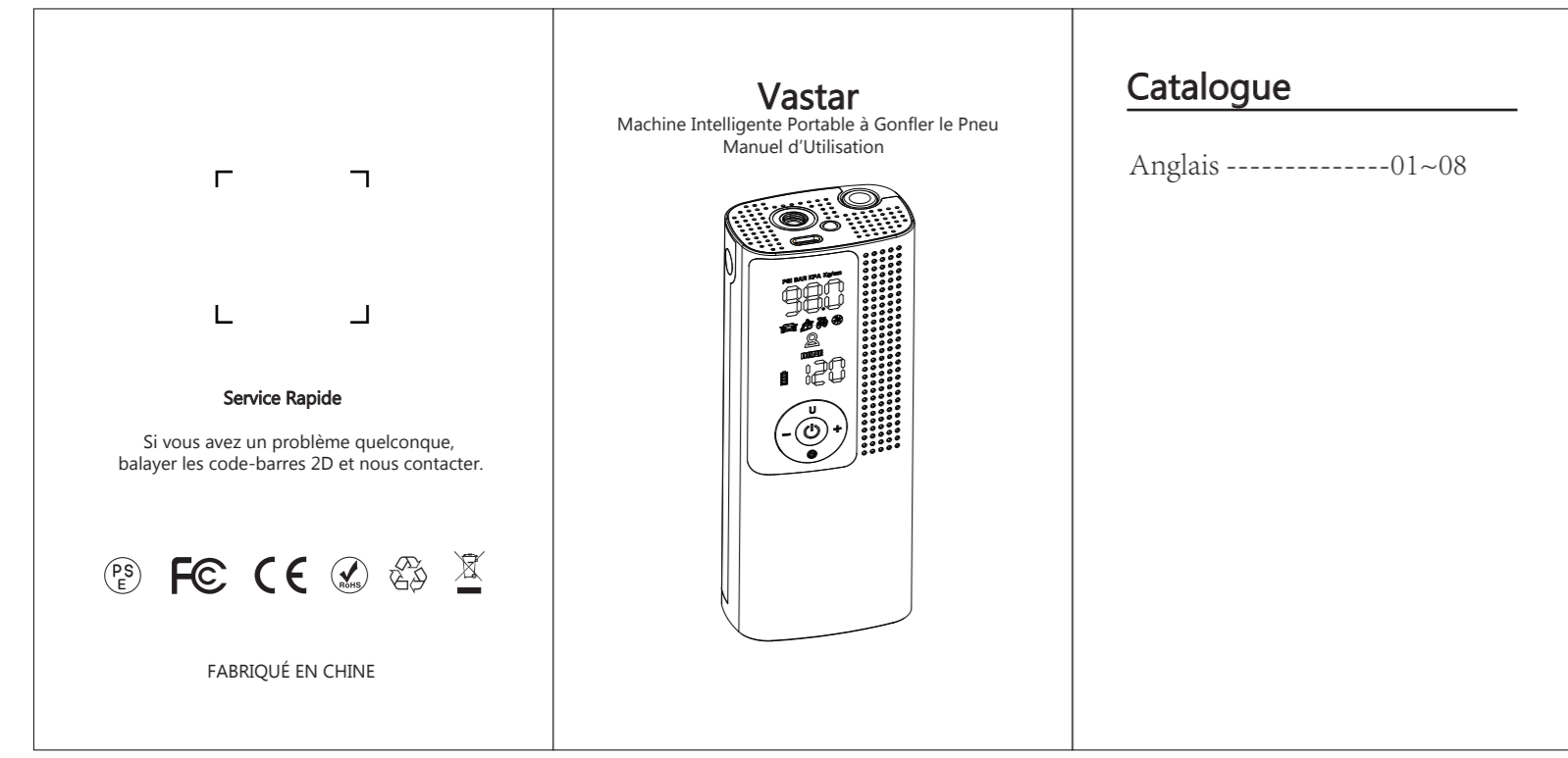

4.ATTENTION:
1) Do not leave during inflation.
2) Please to be away from inflammable and explosive materials.
3) Do not store the product in a humid or dry place.
4) Do not use the product in an open or closed area where there is a fire or explosion risk.
5) Do not use the product if the battery is low.
6) Do not use the product if the battery is low.
7) Do not use the product if the battery is low.
8) Do not use the product if the battery is low.
9) Do not use the product if the battery is low.
10) Do not use the product if the battery is low.

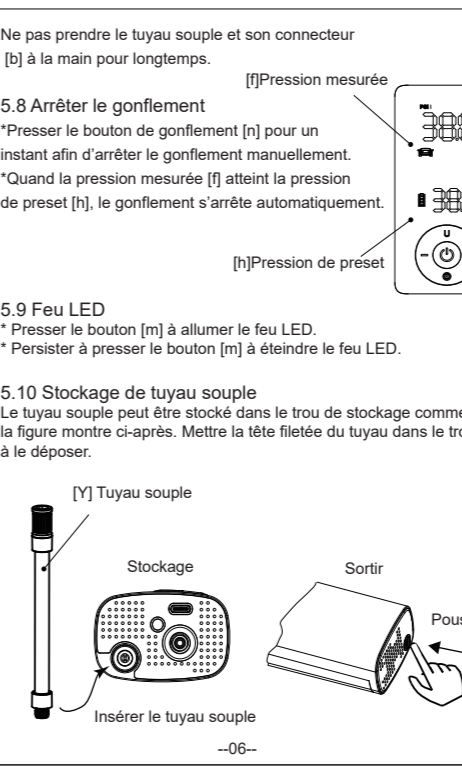
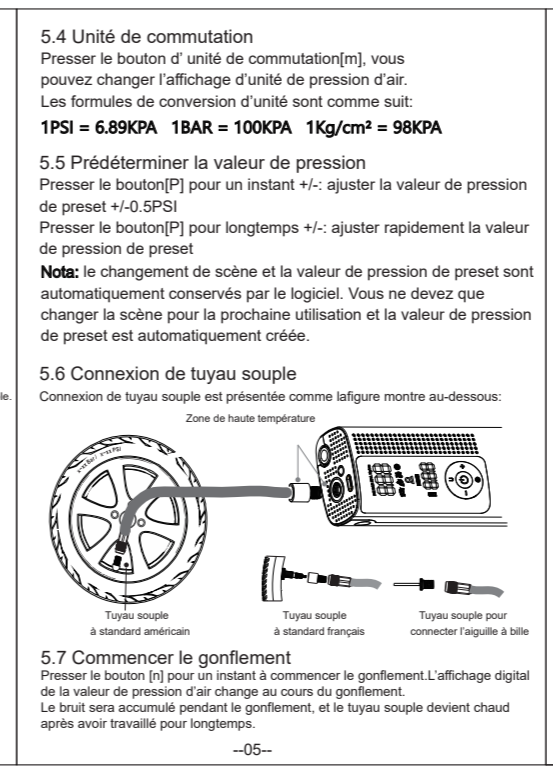
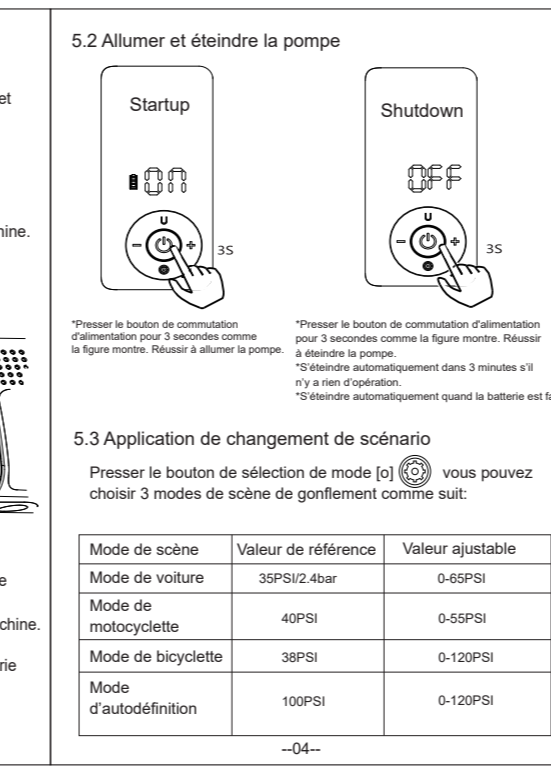

Catégorie	Type	Pressure value
Bicycle	Volume d'air	18-30PSi
	Volume d'air	30-45PSi
	Volume d'air	38-55PSi
	Volume d'air	90-120PSi
Motorcycle	Volume d'air	30-45PSi
Motorcycle	Volume d'air	28-55PSi
Ballon	Volume	2.2-2.8Bar
Basketball	Volume d'air	3-6PSi
Football	Volume d'air	10-12PSi
Volleyball	Volume d'air	4-6PSi
Rugby	Volume d'air	10-14PSi

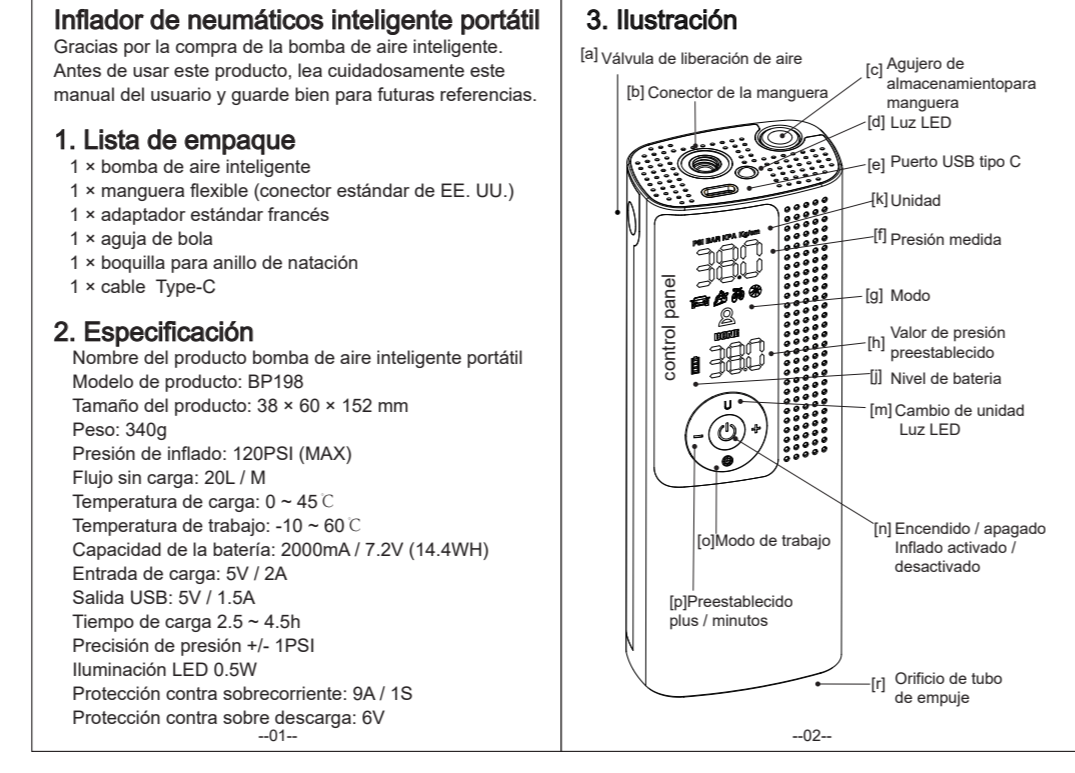
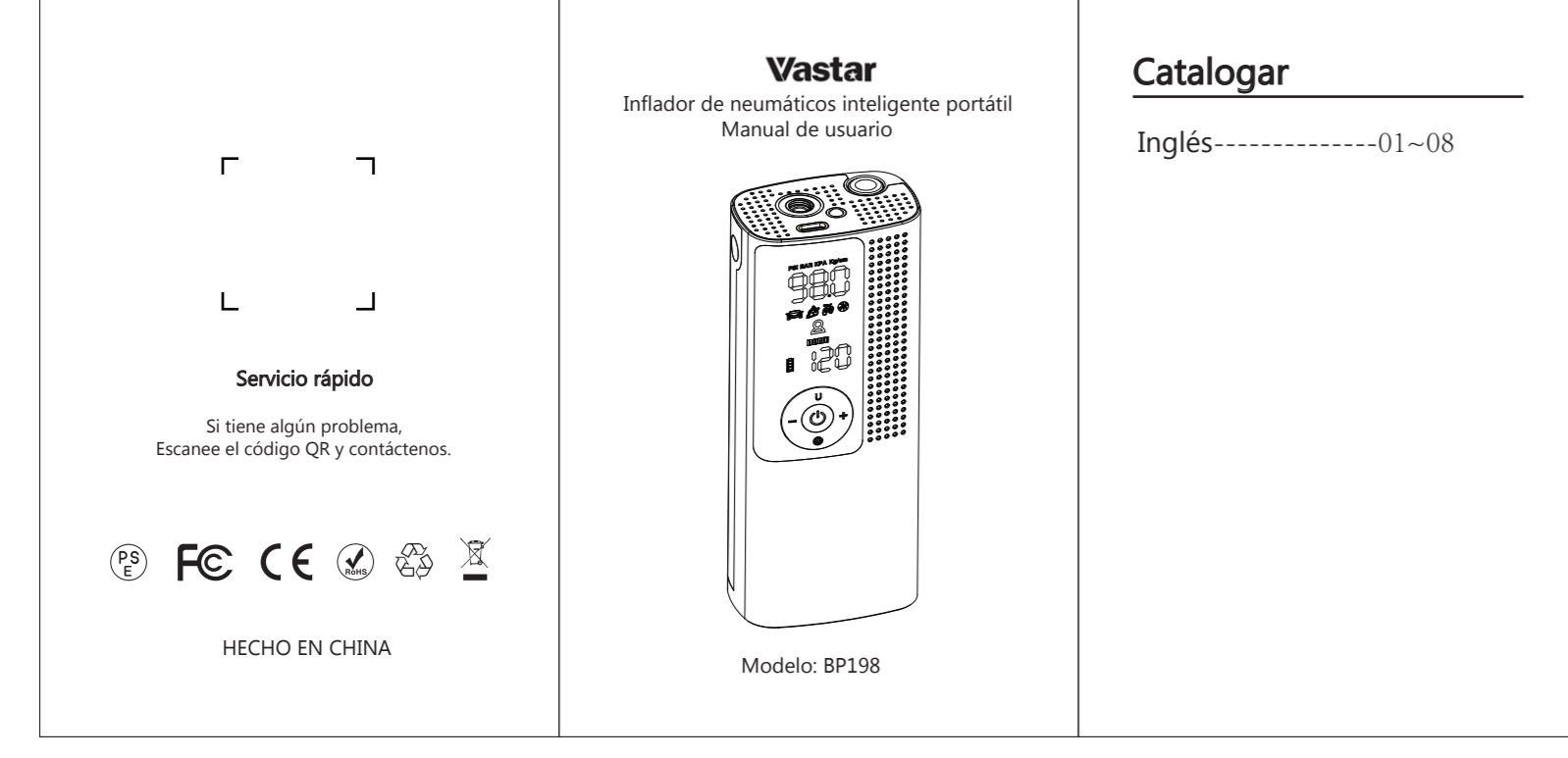

4.ATENCIÓN:
1) No se debe abandonar el producto durante la inflación.
2) Manténgase alejado de los materiales inflamables y explosivos.
3) Evite la humedad, la arena y las calidas.
4) No guarde el producto en un lugar demasiado frío o demasiado caliente.
5) No se permite el uso del producto en un área abierta o cerrada donde haya riesgo de incendio o explosión.
6) No use el producto si la batería está baja.
7) No use el producto si la batería está baja.
8) No use el producto si la batería está baja.
9) No use el producto si la batería está baja.
10) No use el producto si la batería está baja.

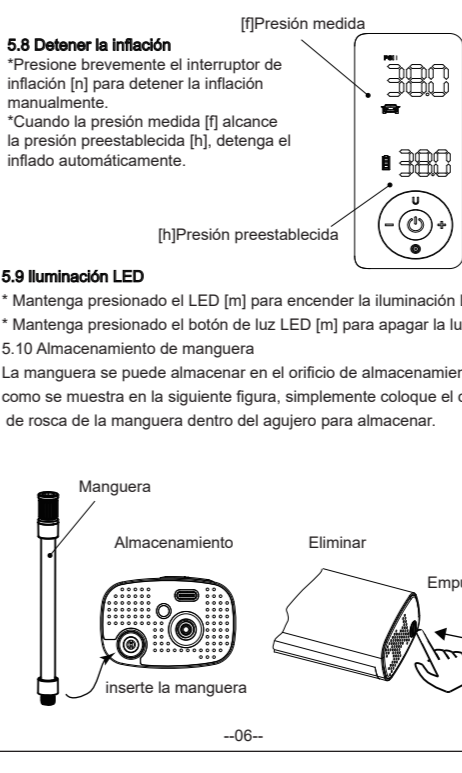
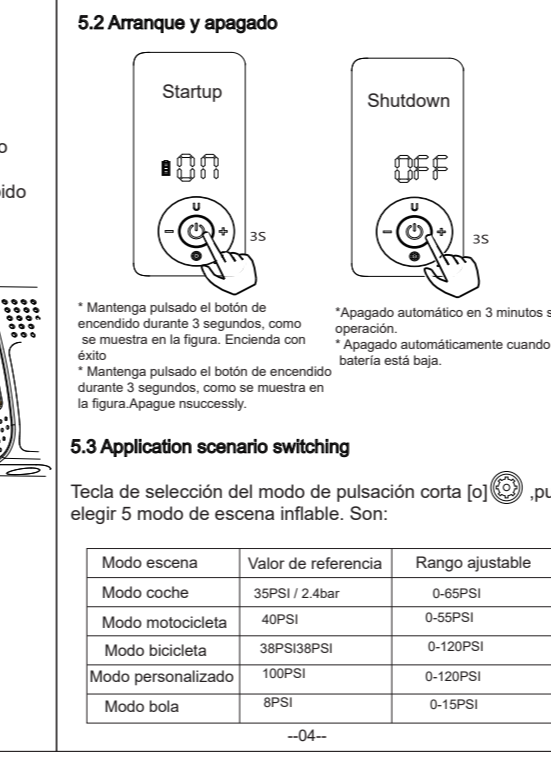

categoría	Tipo	Pressure value
bicicleta	Presión	18-30PSi
	10-16 pulgadas	30-45PSi
	20-30 pulgadas	38-55PSi
	carretera / montaña	90-120PSi
motorcicleta		30-45PSi
Coche eléctrico		28-55PSi
code		2.2-2.8Bar
Prueba de pelota para niños		3-6PSi
Basketball		7-9PSi
Fútbol		10-12PSi
Volleyball		4-6PSi
Rugby		10-14PSi

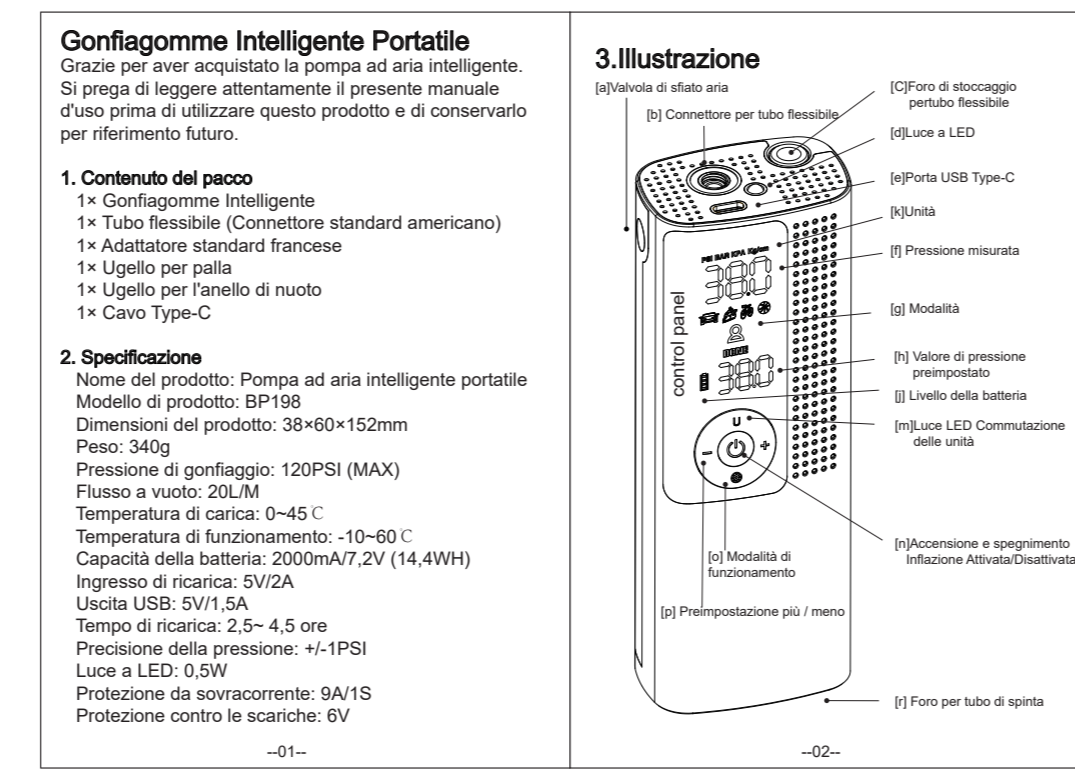
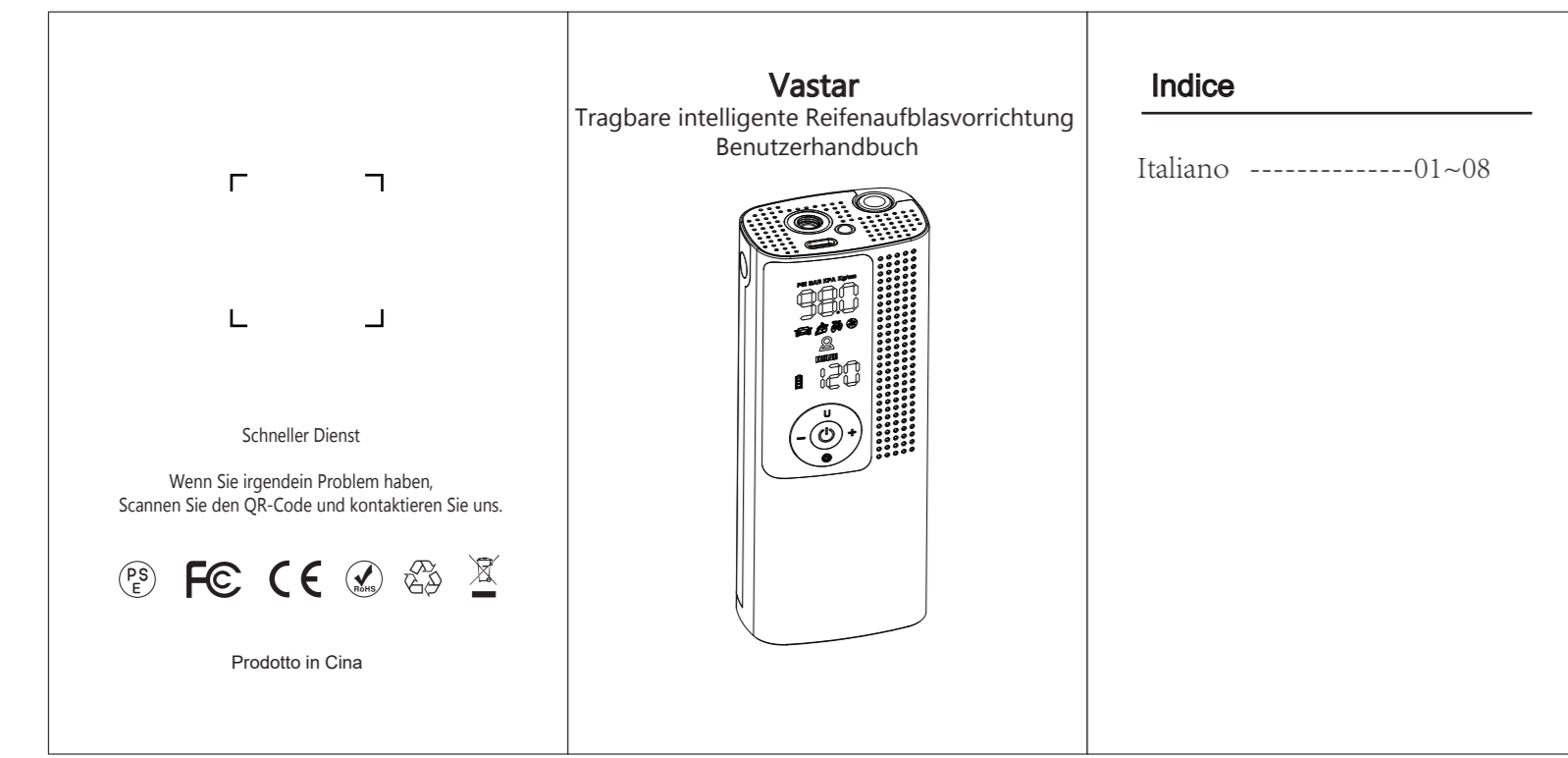

4. ATTEZIONE:
1) Non lasciare durante l'inflazione.
2) Tenersi lontano da materiali infiammabili ed esplosivi.
3) Evitare l'umidità, la sabbia e la calida.
4) Non conservare il prodotto in un luogo troppo caldo o troppo freddo.
5) È vietato usare il prodotto in un'area aperta o chiusa dove c'è il rischio di incendio o esplosione.
6) Non usare il prodotto se la batteria è scarica.
7) Non usare il prodotto se la batteria è scarica.
8) Non usare il prodotto se la batteria è scarica.
9) Non usare il prodotto se la batteria è scarica.
10) Non usare il prodotto se la batteria è scarica.

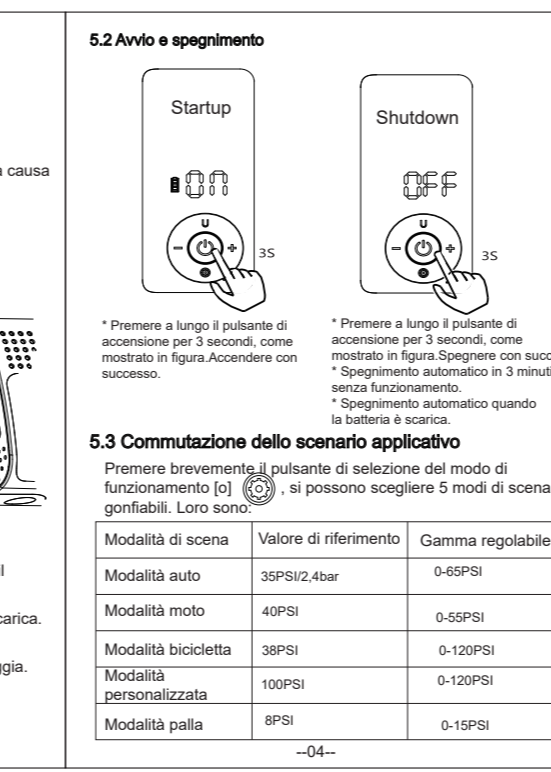

categoria	Tipo	Valore di pressione
Bicicletta	Pressione	18-30PSi
	Pressione da 10-16 pollici	30-45PSi
	Pressione da 20-30 pollici	38-55PSi
	Pressione da 90-120PSi	
Motorcicla		30-45PSi
Macchina		28-55PSi
Prueba de pelota para niños		3-6PSi
Basketball		7-9PSi
Fútbol		10-12PSi
Volleyball		4-6PSi
Rugby		10-14PSi