

RAF SE5a Manual



Tony Ray's AeroModel



RAF SE5a- Kit Inventory

- Wood Part: Balsa wood Sheets *6, Basswood Sheets *1
- Hardware Part: Carbon rod * 2, Micro Hinge * 1, Micro screw * 20, Rubber wheel * 2, Heat shrink tube*1, Mini Magnet*8
- Paper Part: Installation drawings *2, Covering tissue * 1

Required Electronics

- RC Transmitter with 3 or 4 channels
- Receiver/1.7g Micro servo
- Motor 8.5mm coreless motor with gearbox
- Propeller,5.5in or 138mm prop /LiPo battery

Part1.Fuselage

Step1

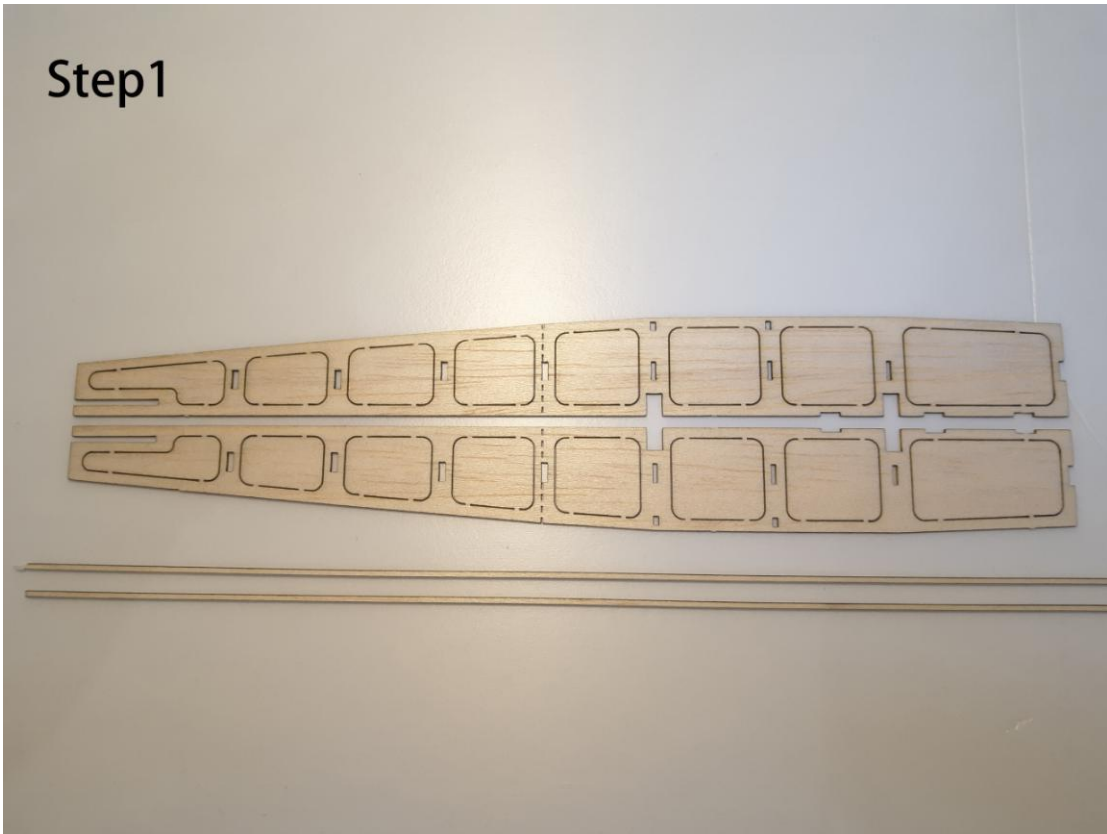

Step2

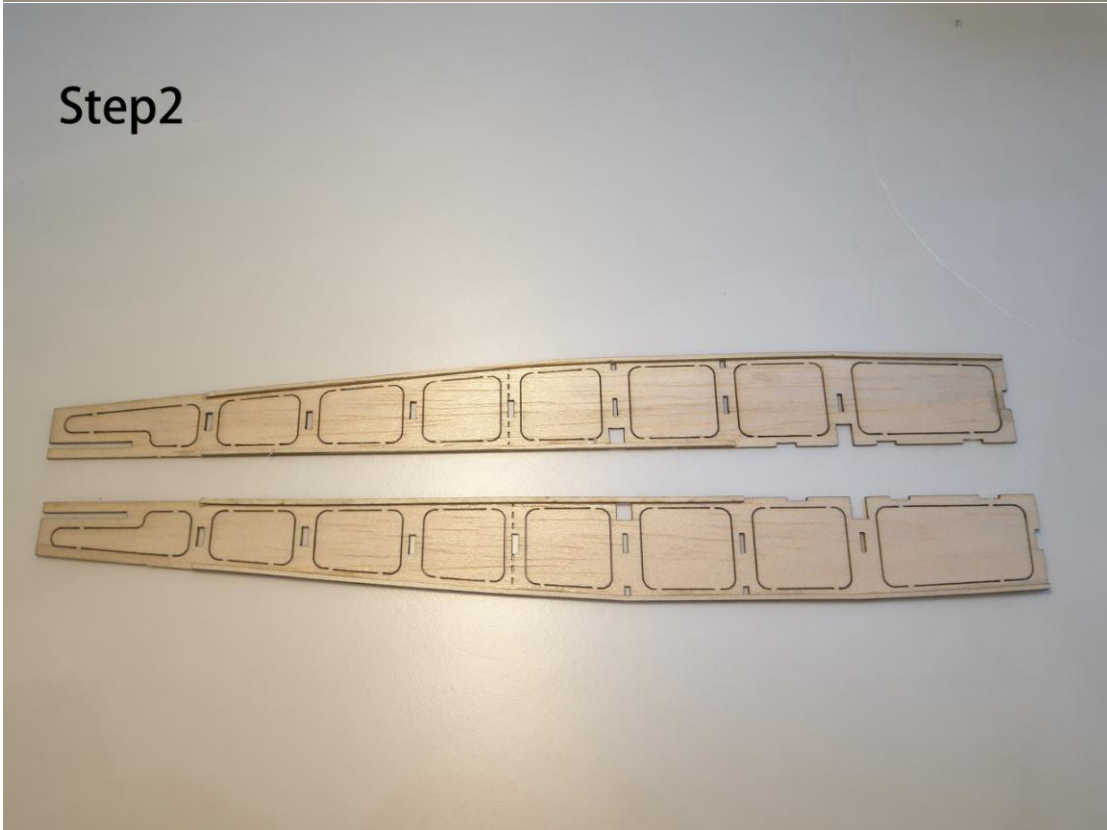

Step3

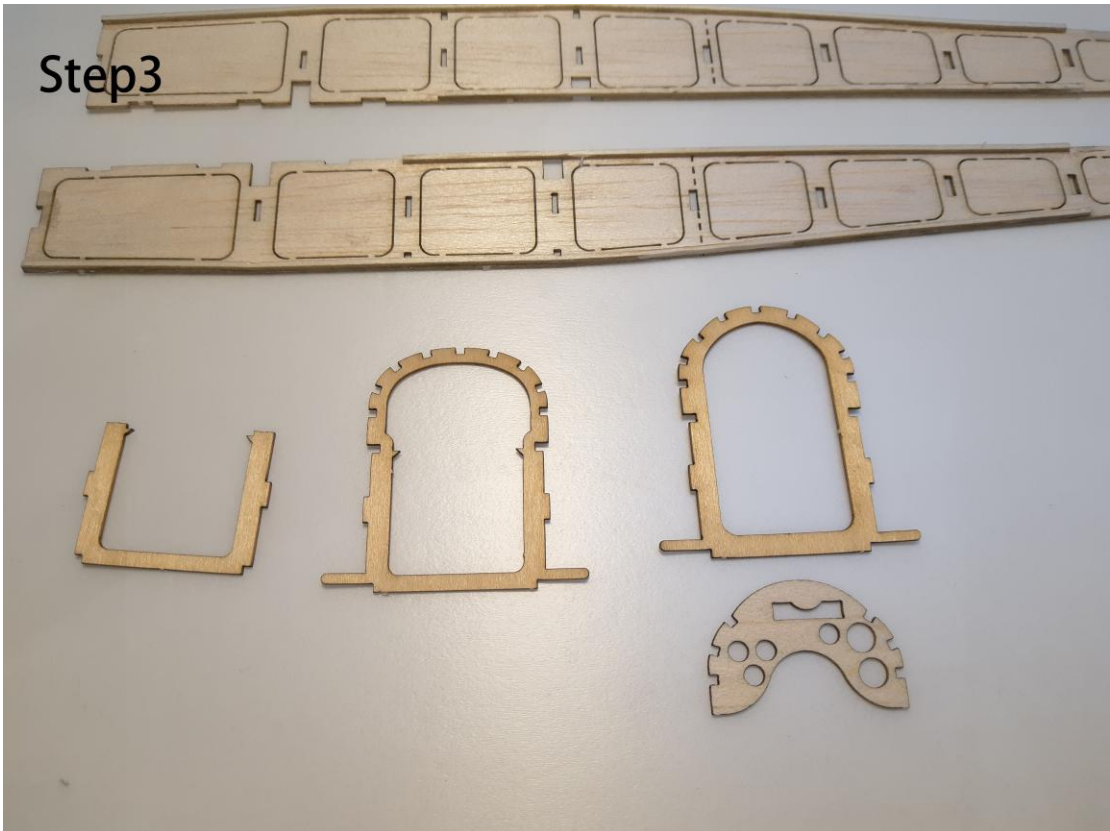

Step4

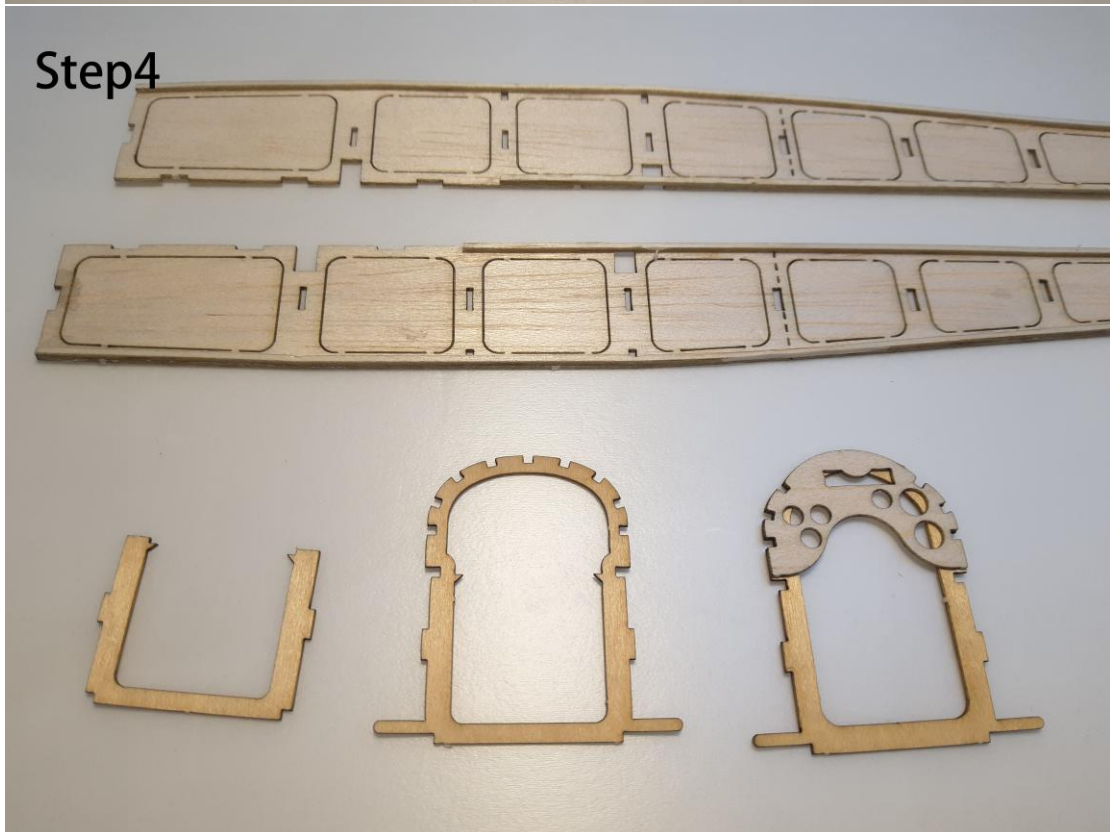

Step5

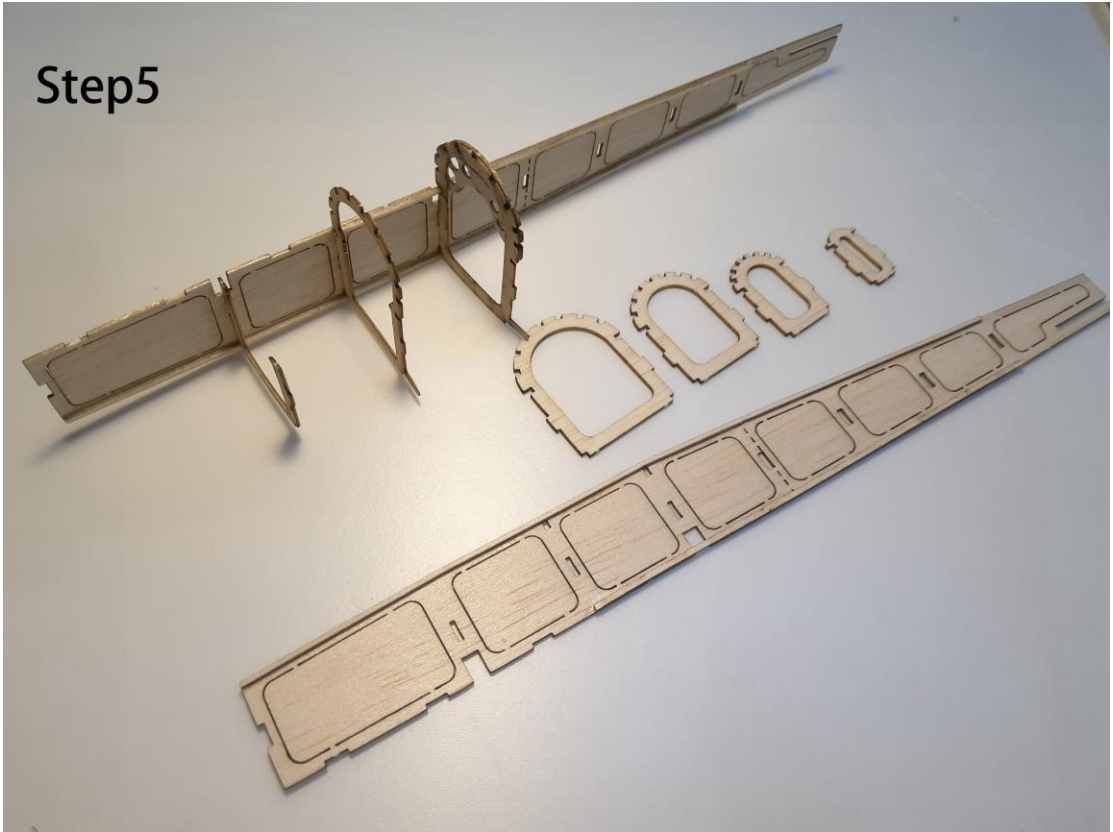

Step6

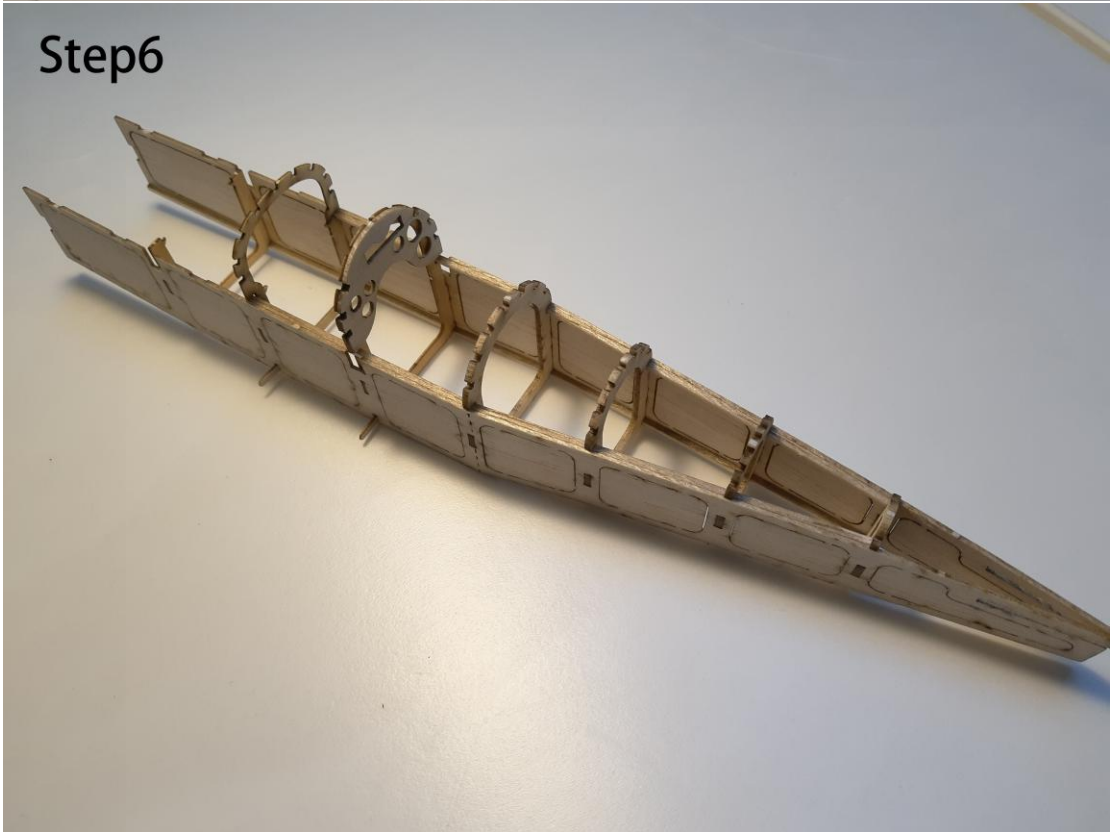

Step7

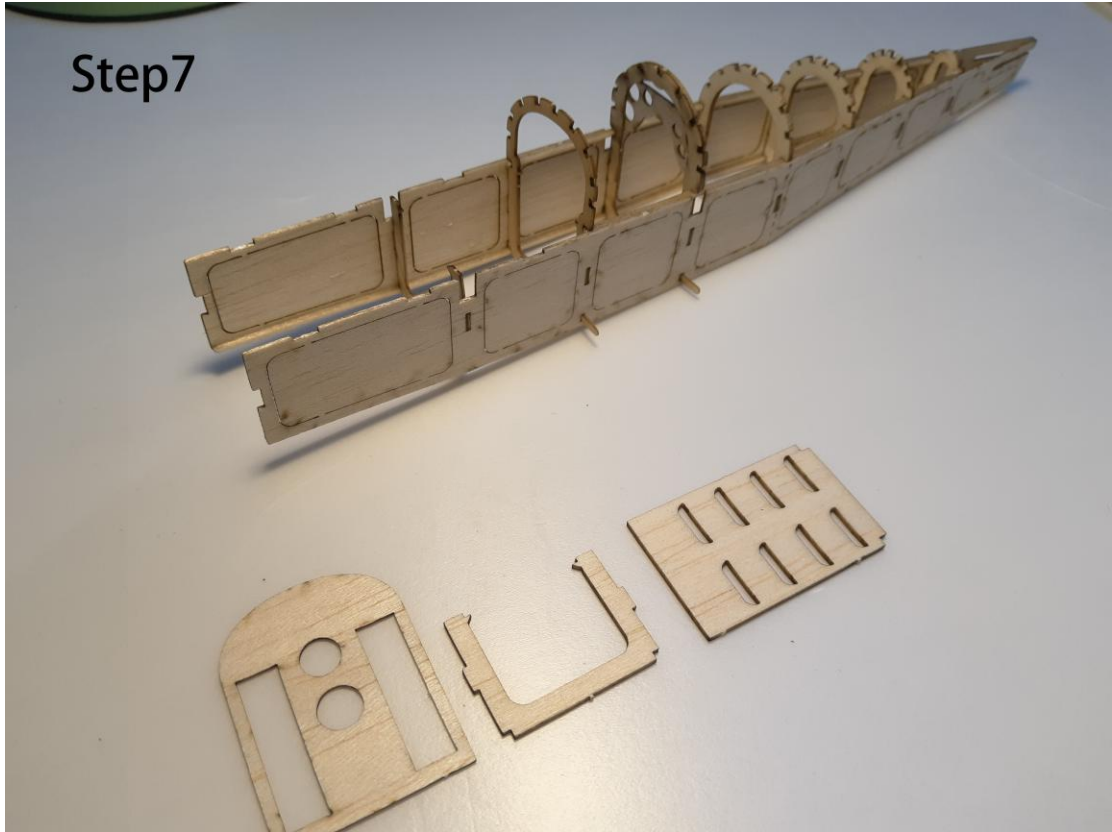

Step8

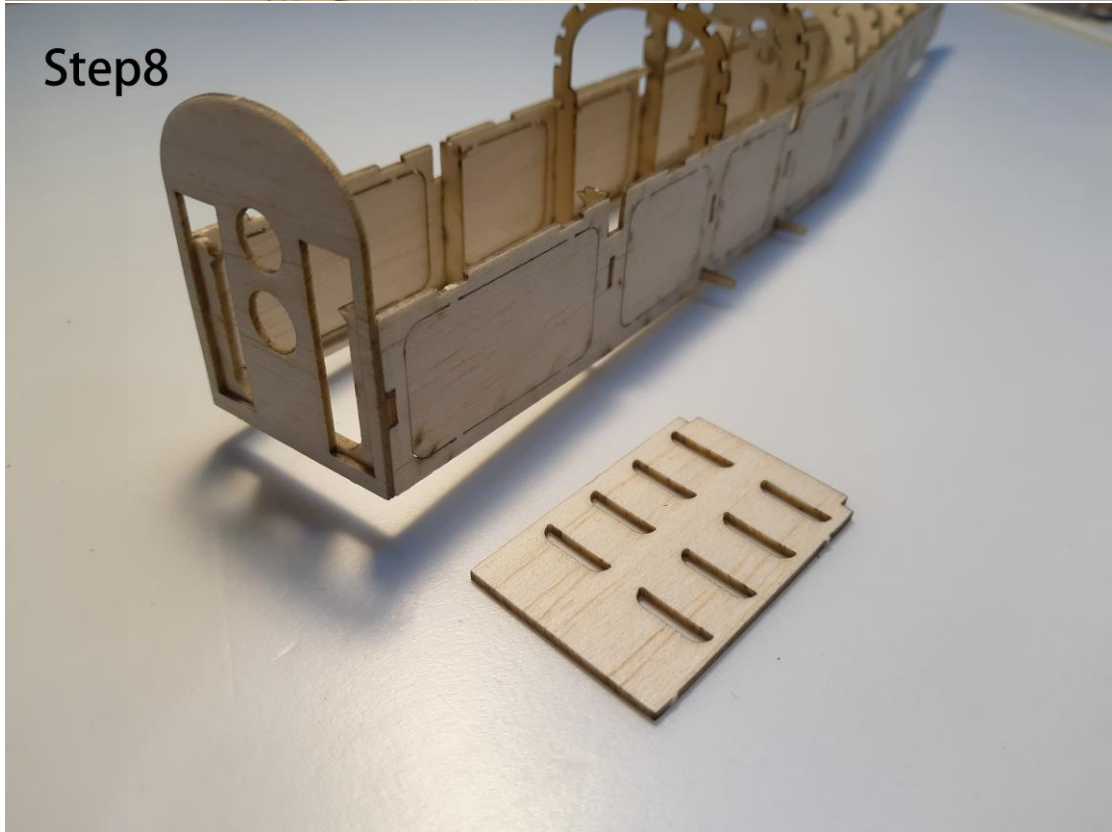

Step9

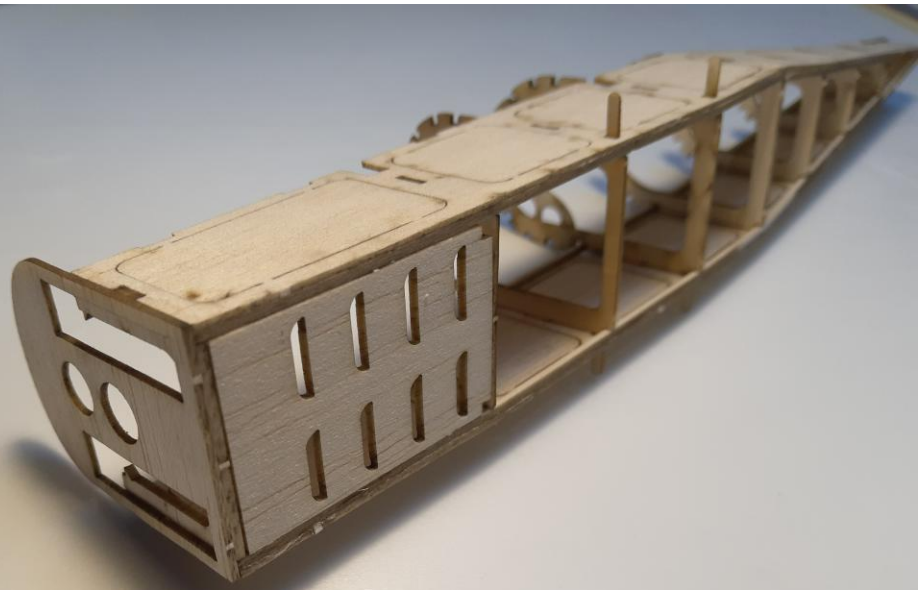

Step10

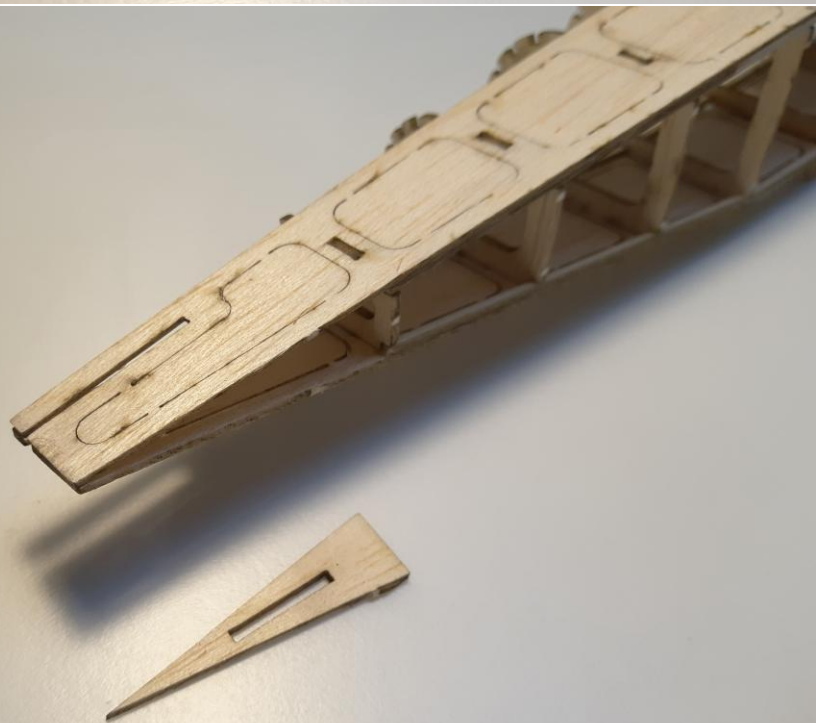

Step11

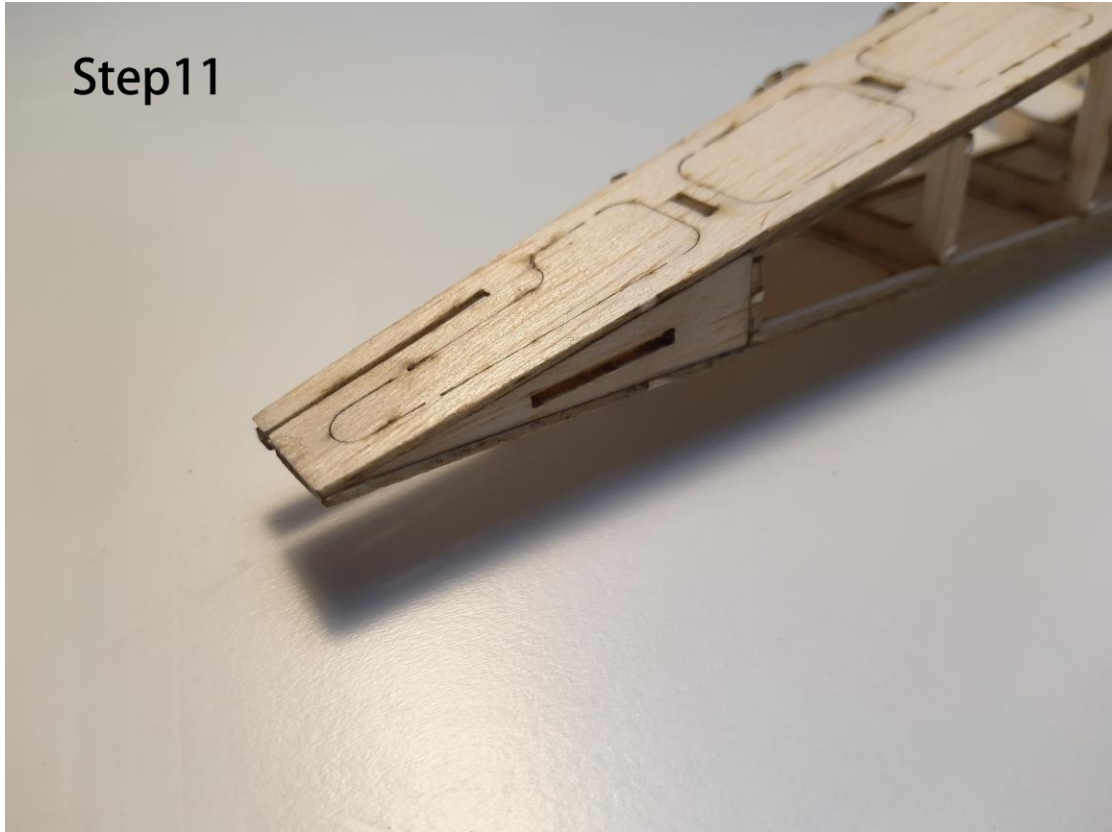

Step12

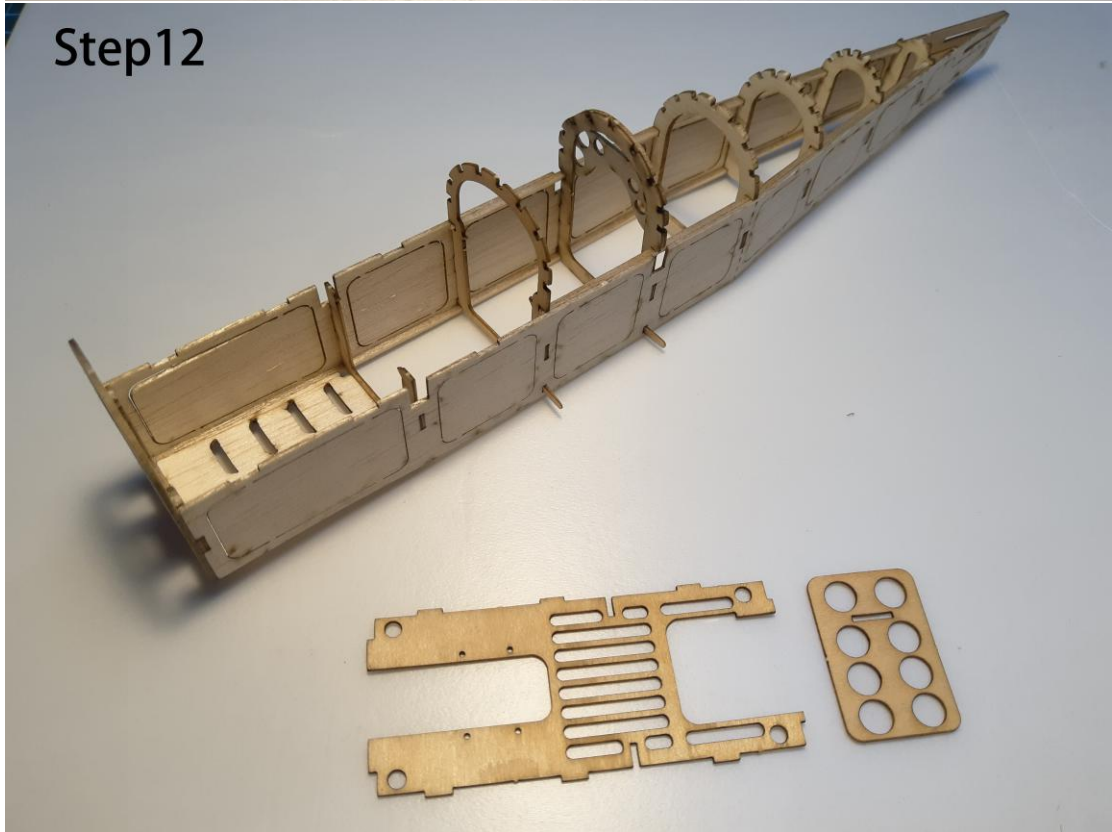

Step13

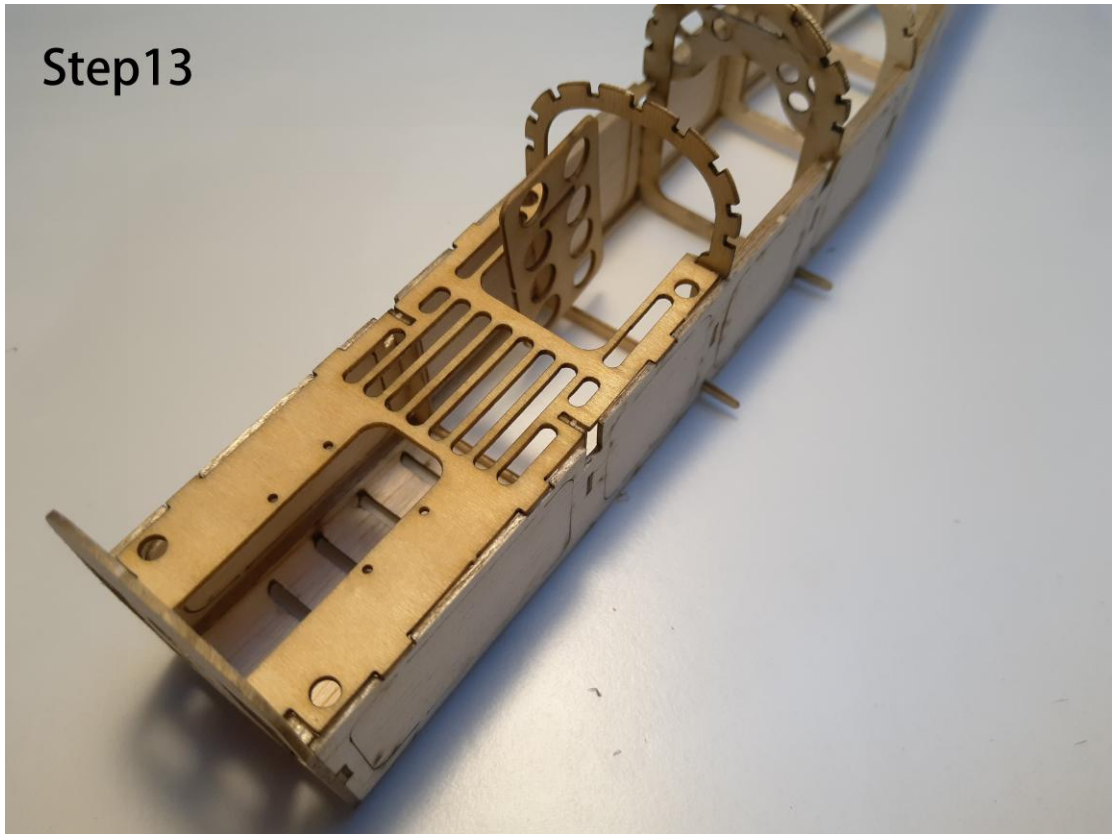

Step14

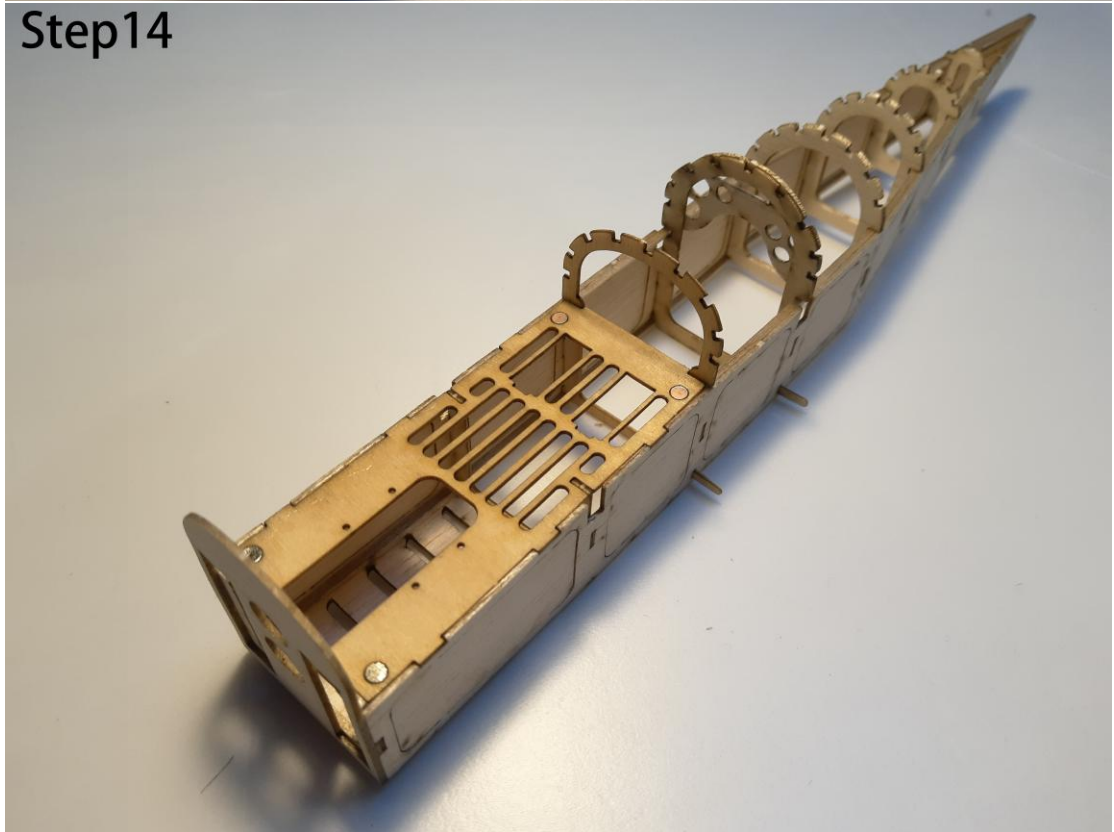

Step15

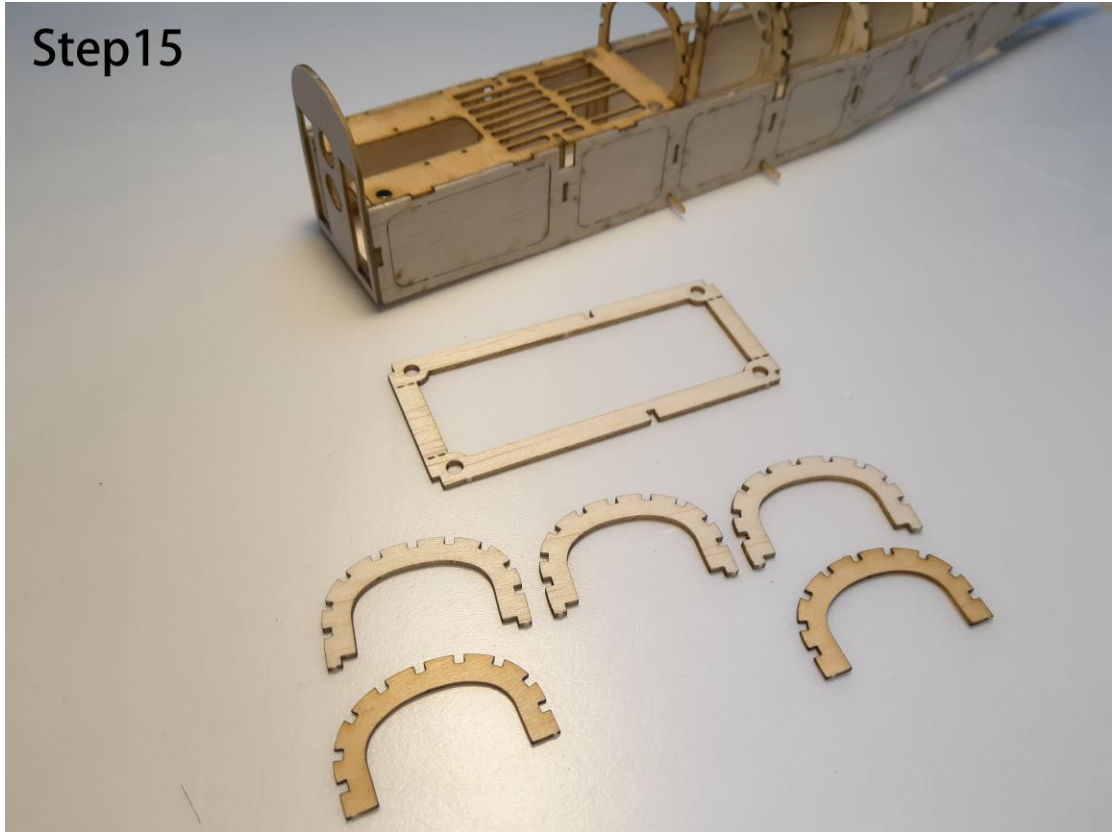

Step16

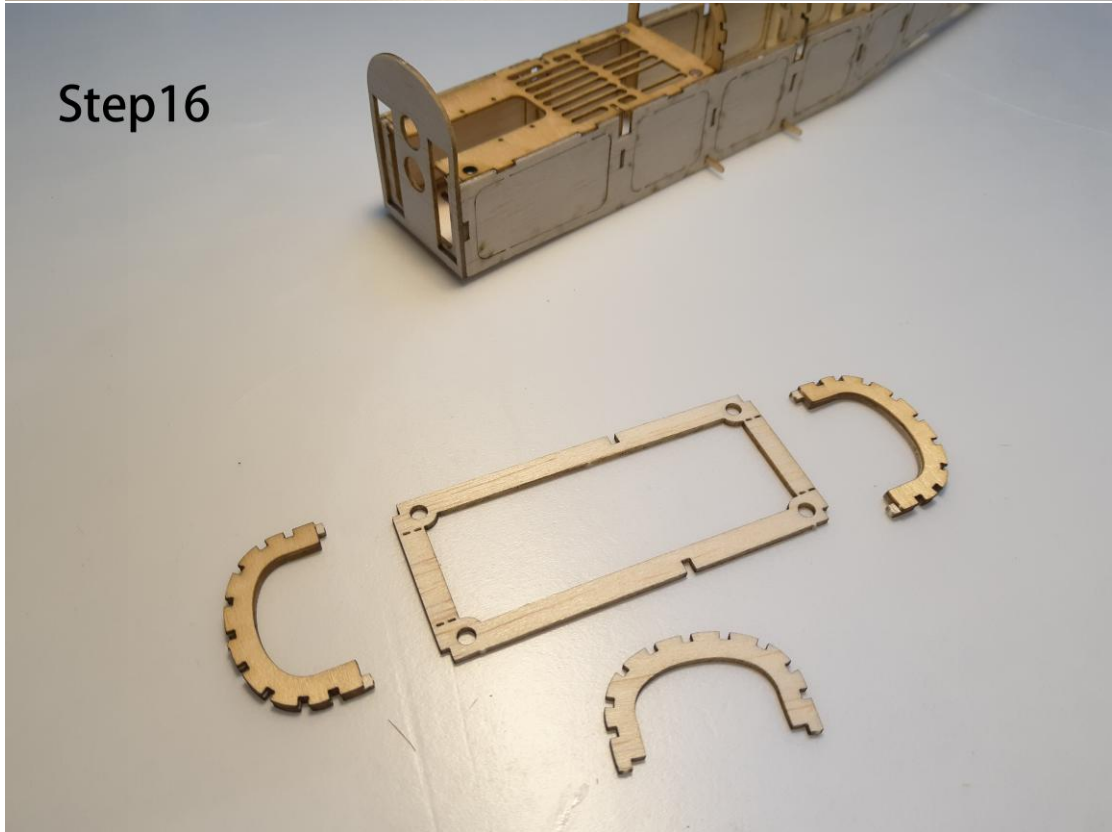

Step17

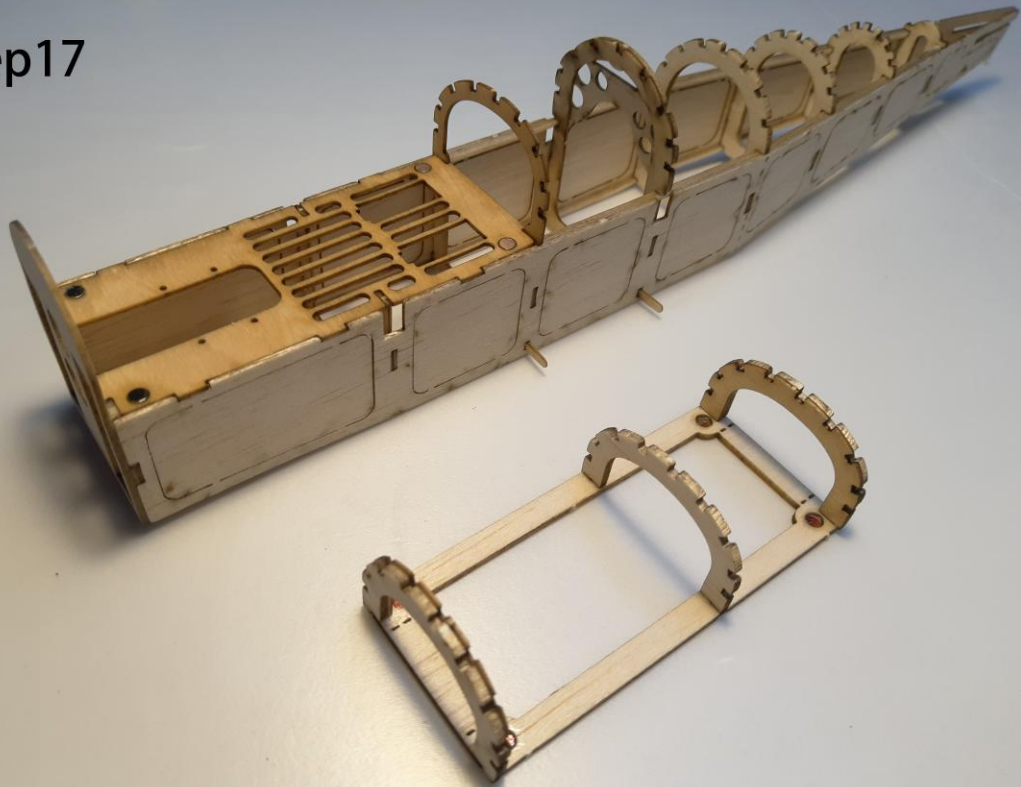

Step18

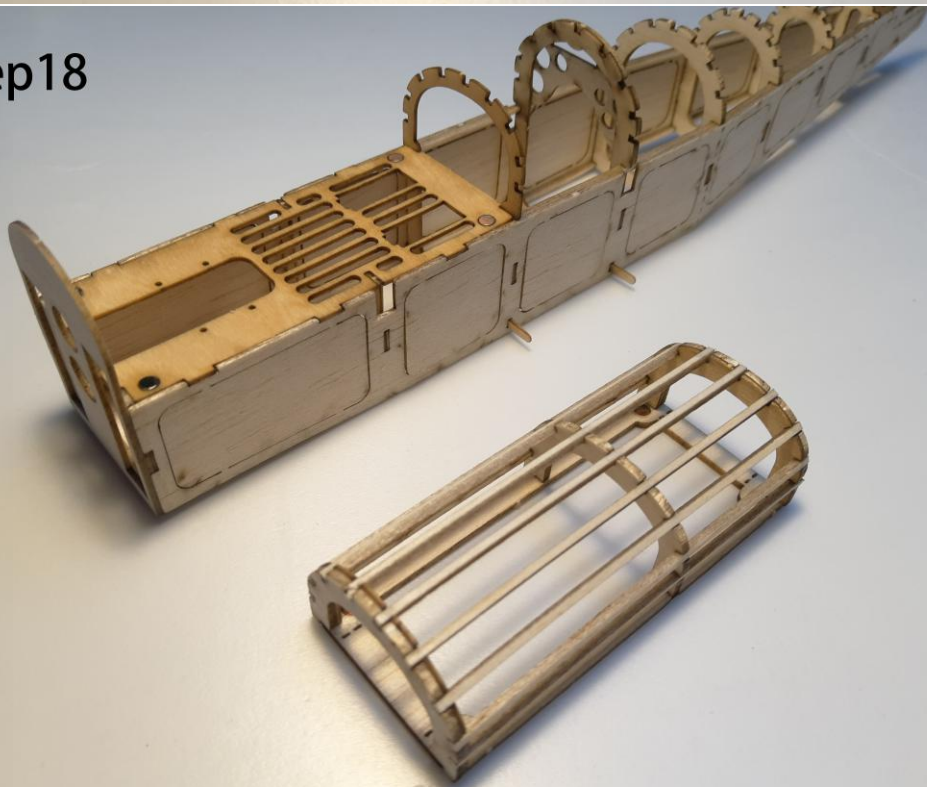

Step19

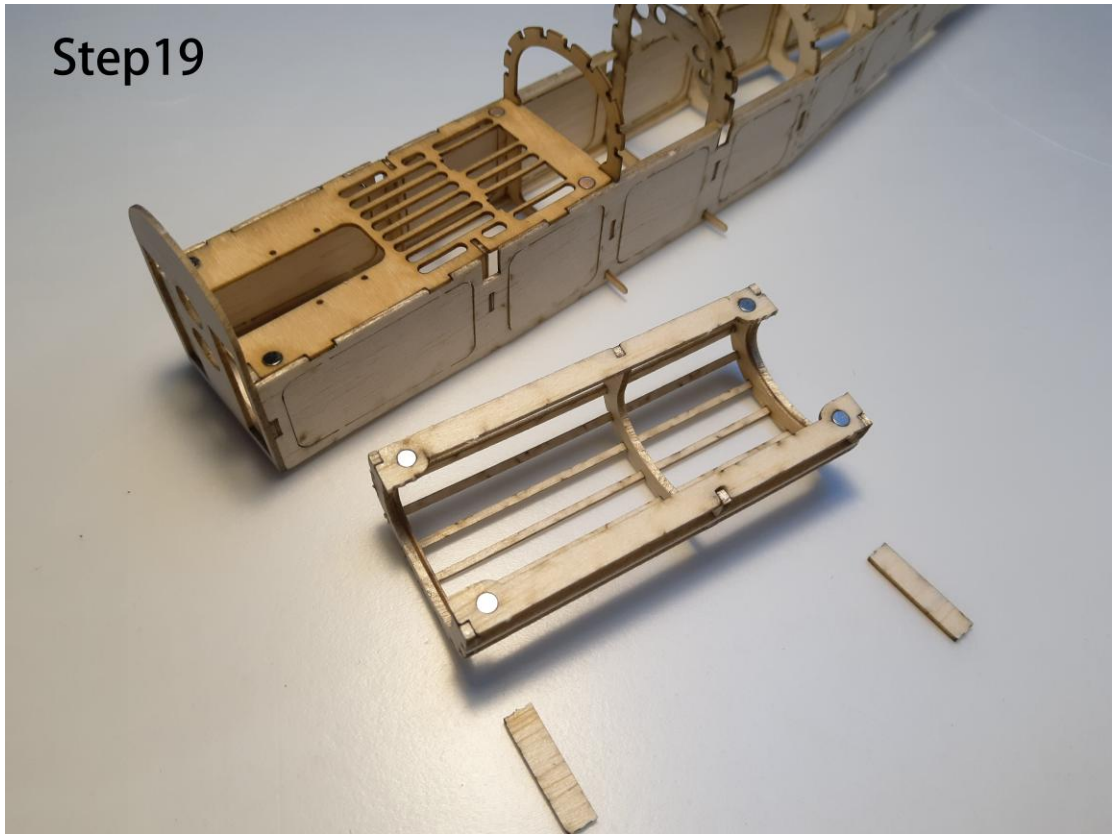

Step20

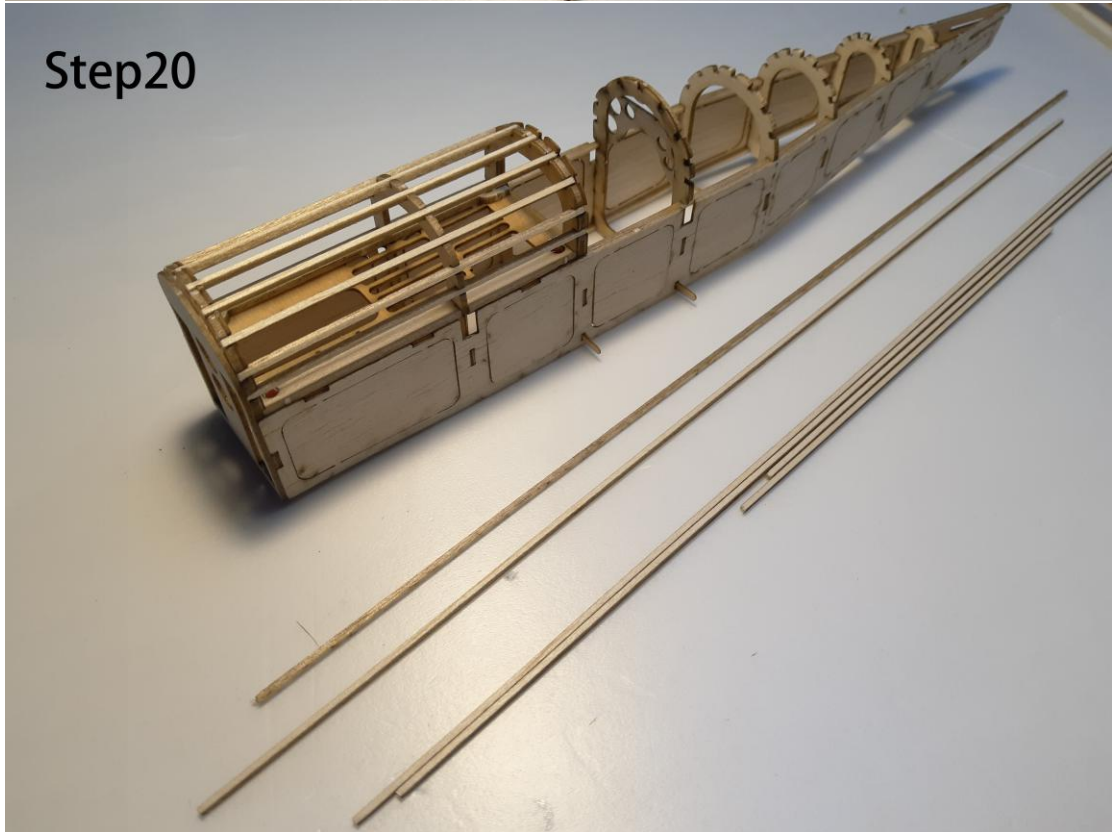

Step21



Step22

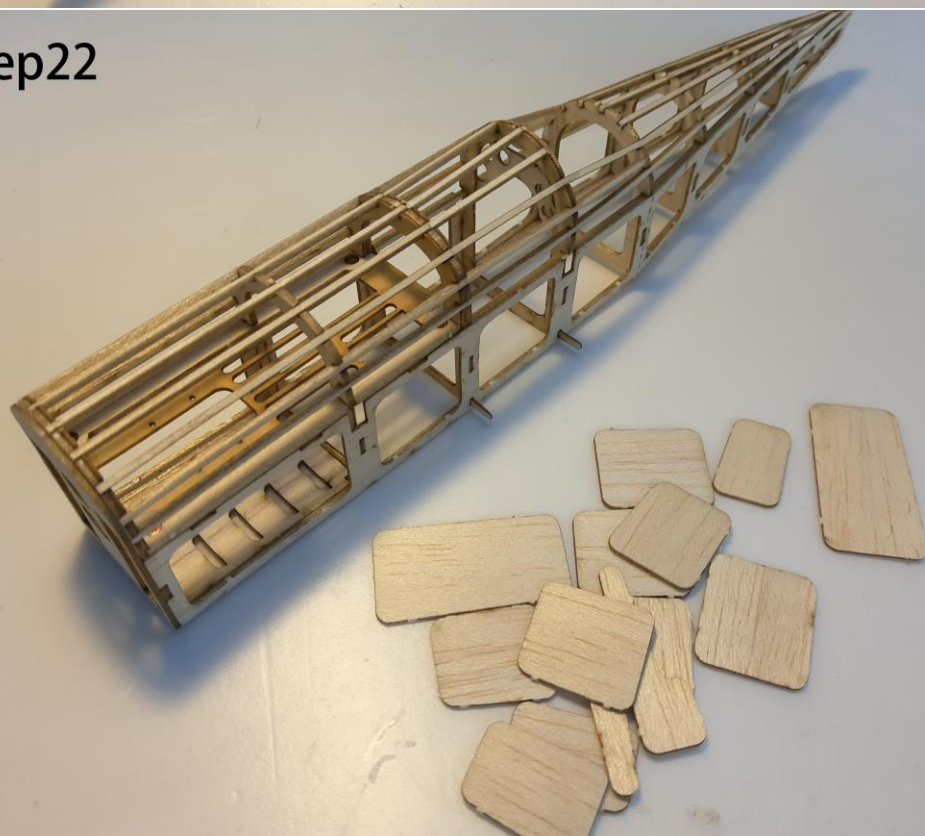

Step23

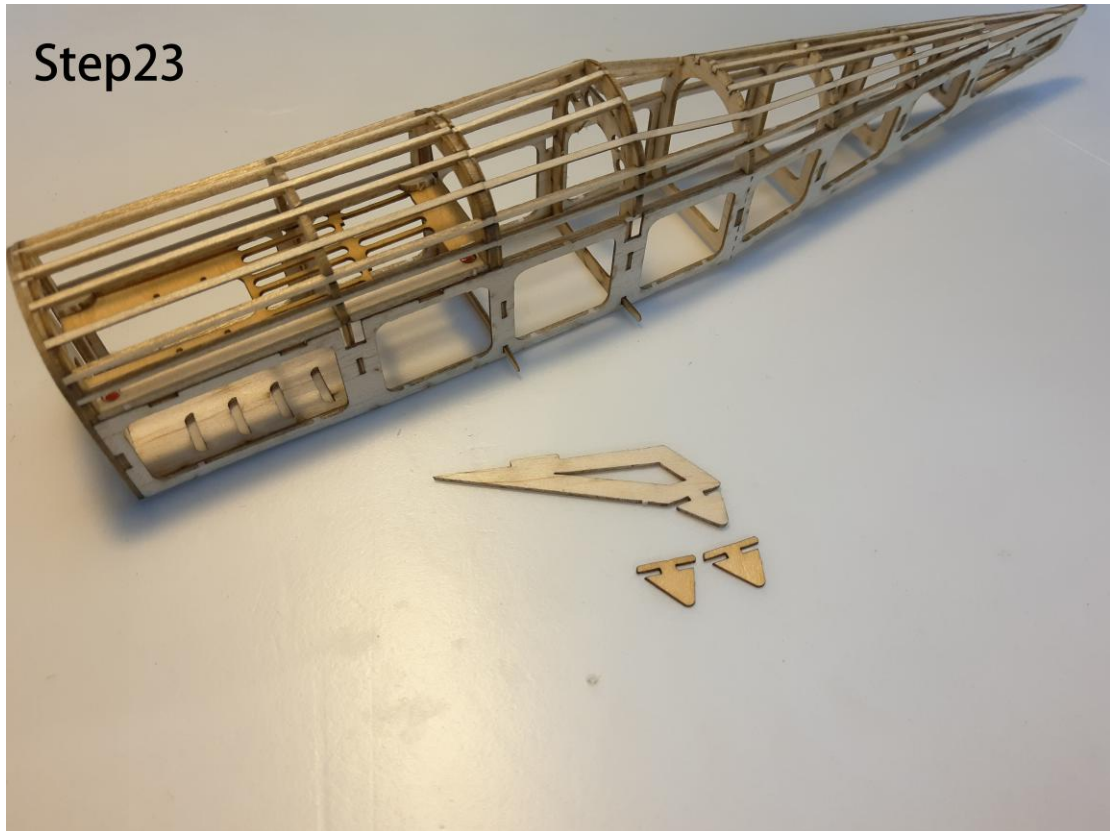

Step24

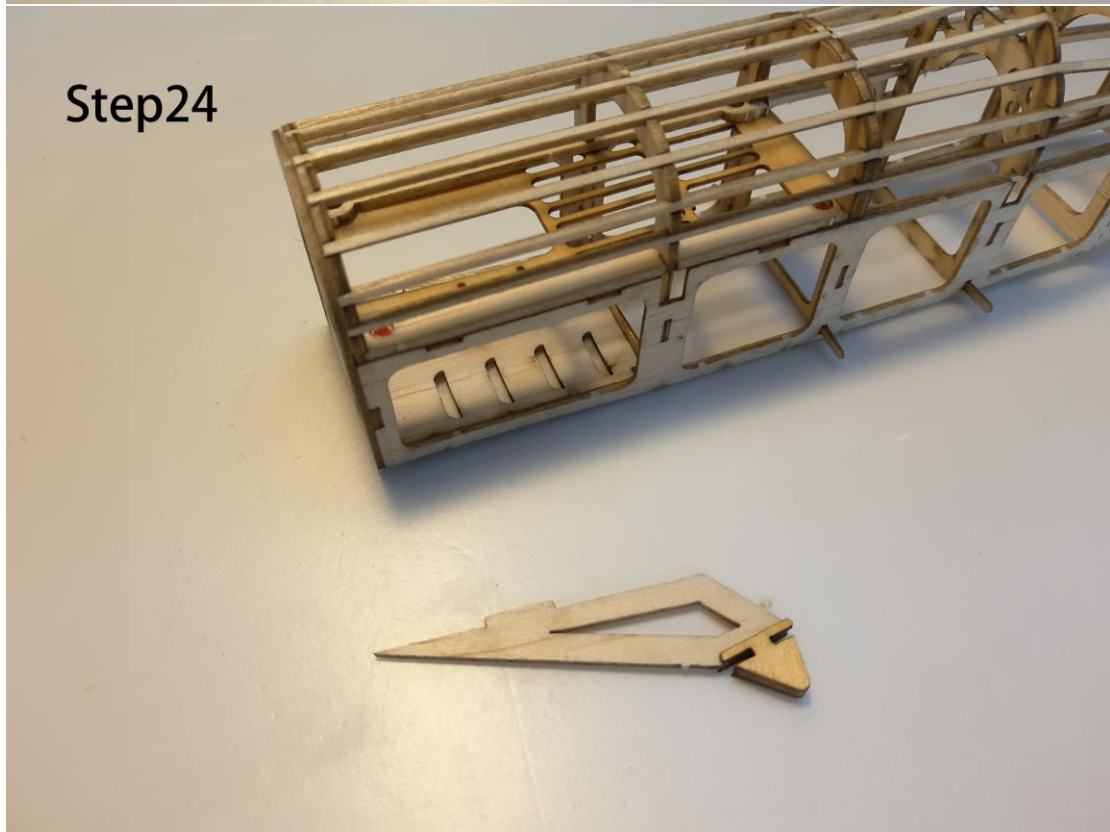

Step25

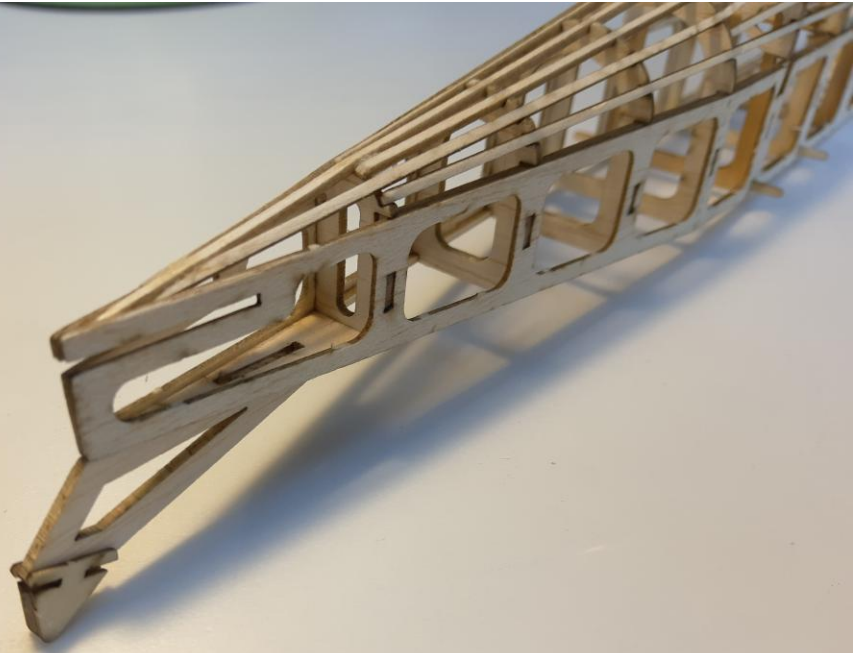

Step26

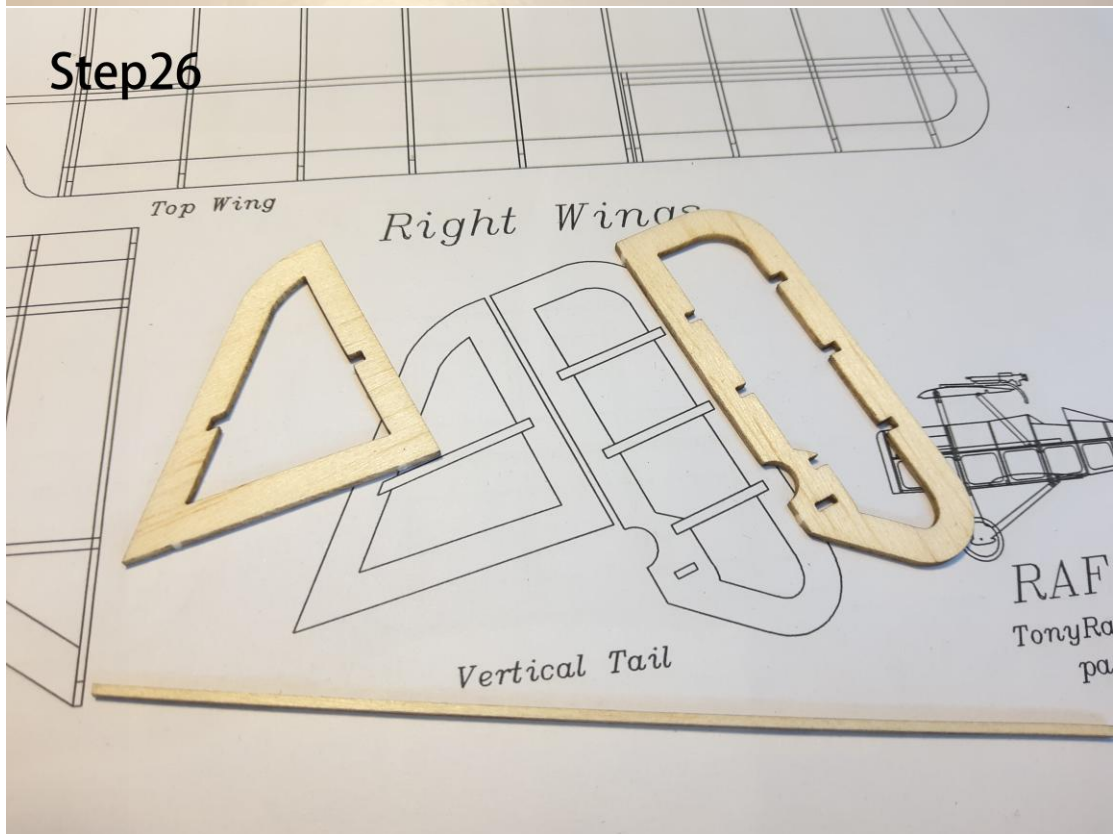

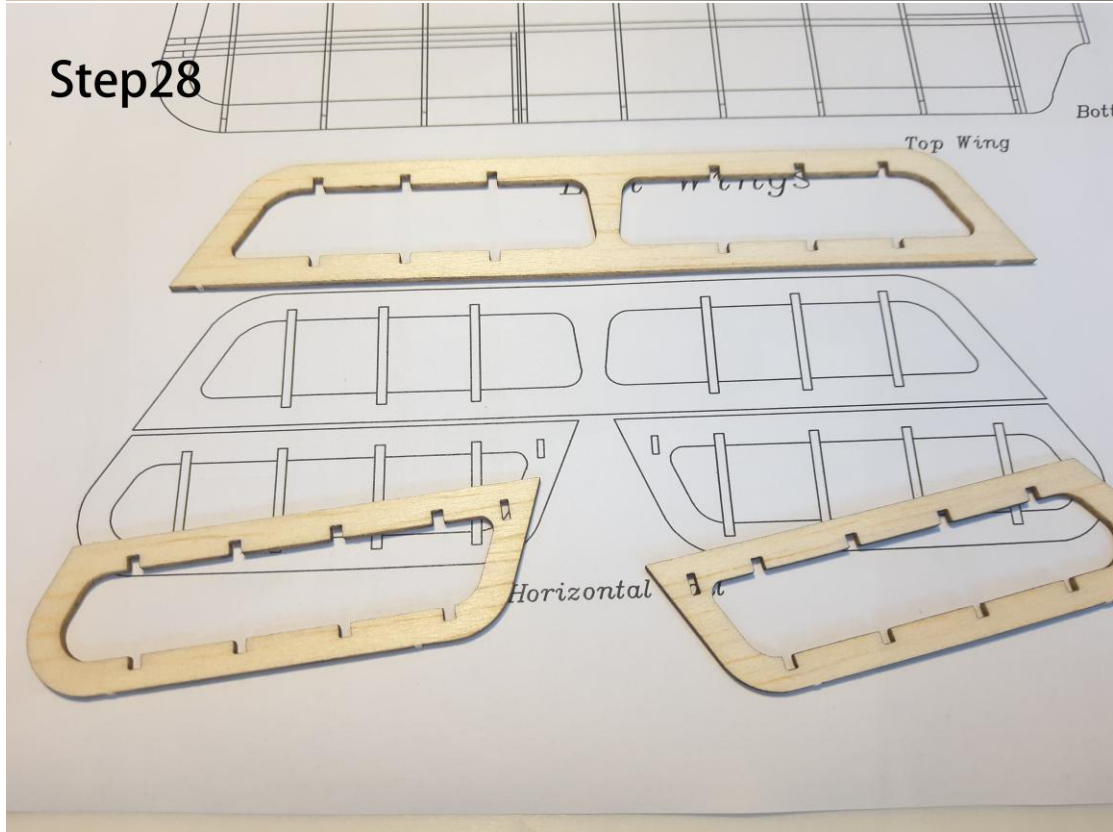
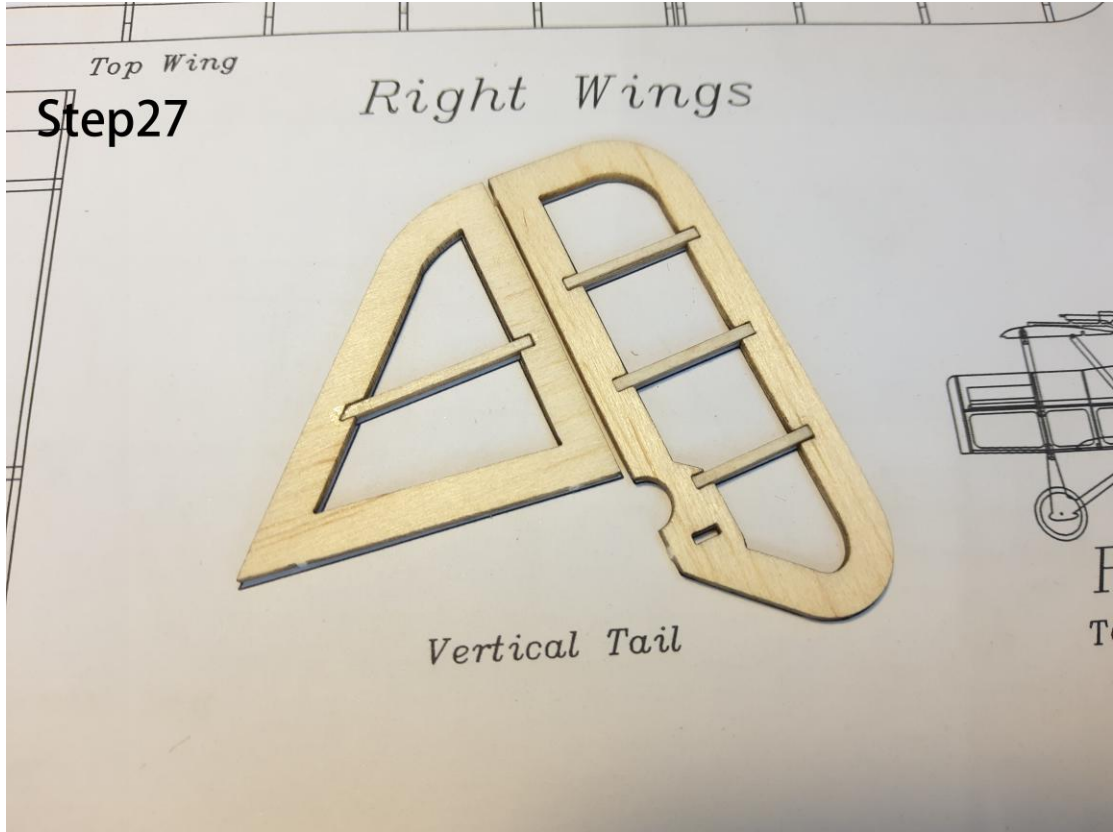

Step29

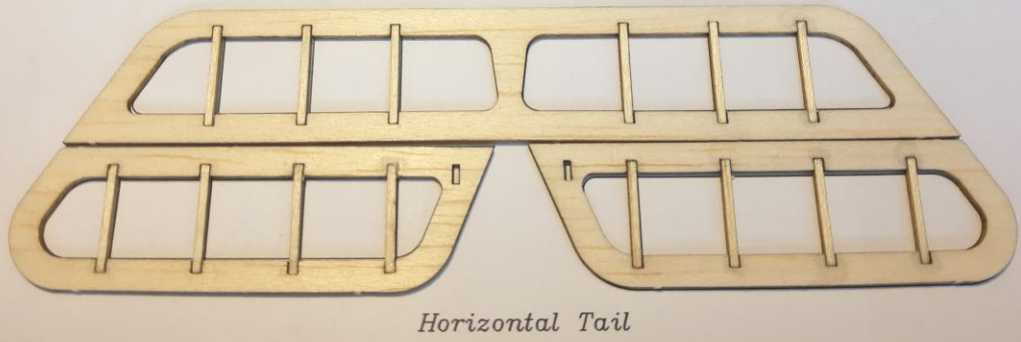
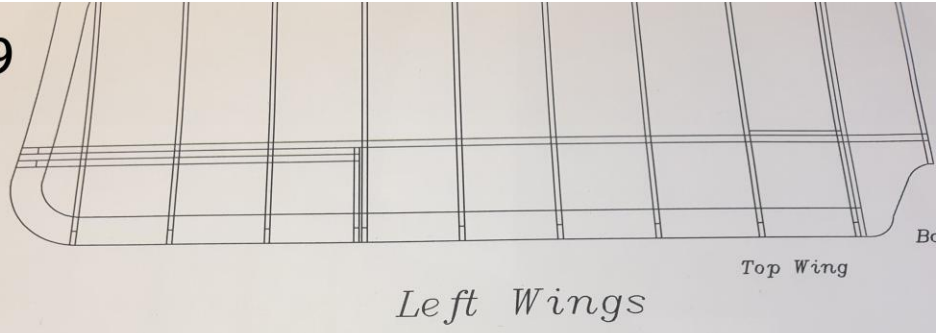

Step30

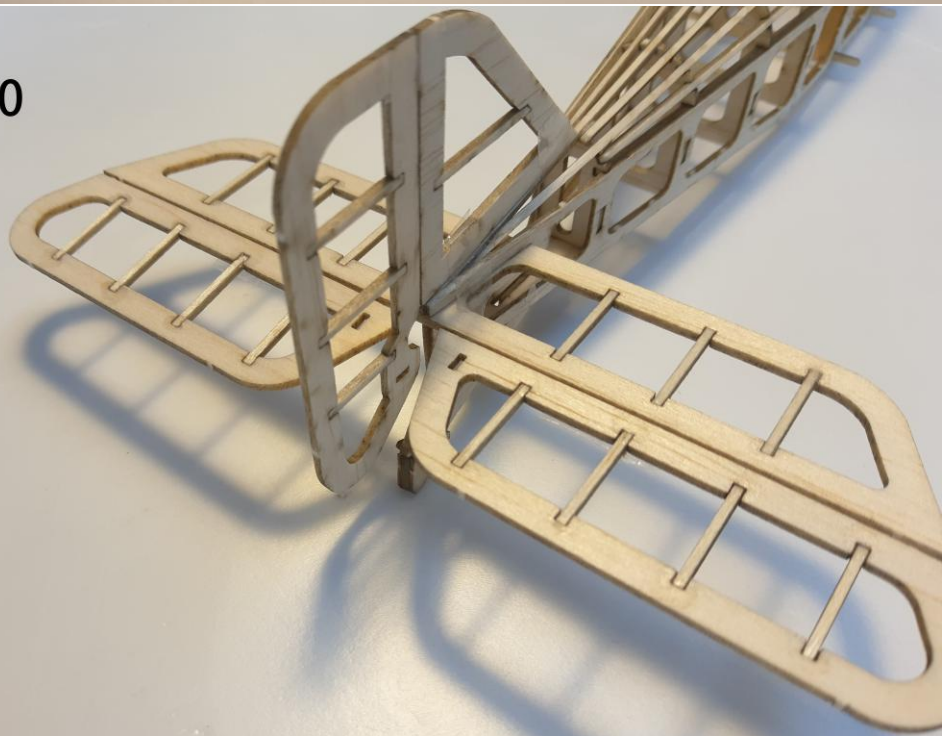

Step31

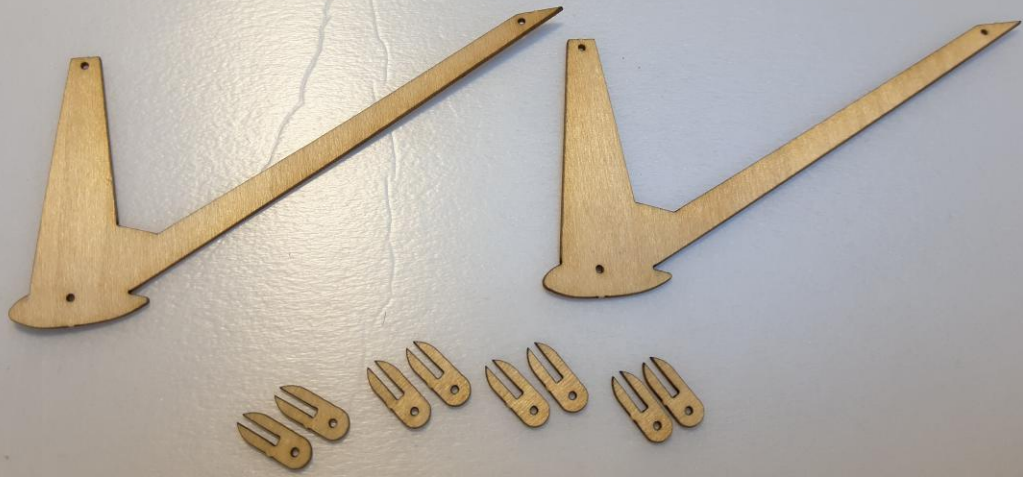

Step32



Step33

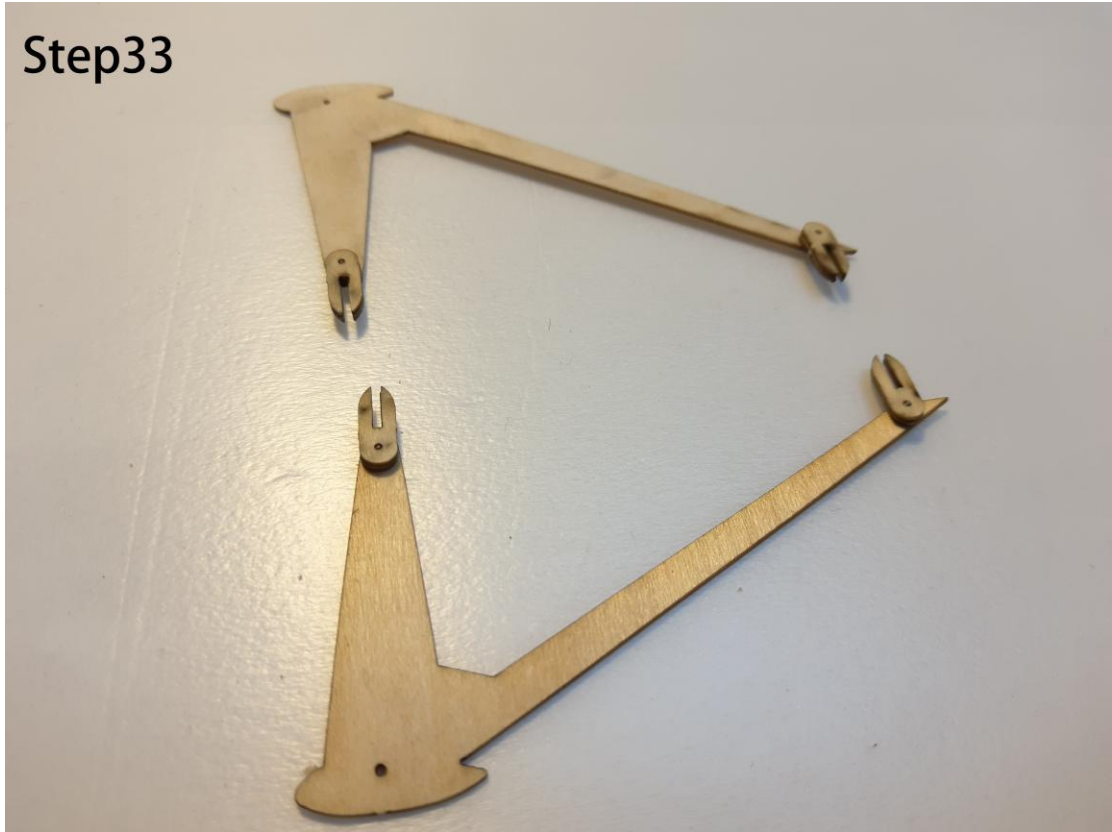

Step34

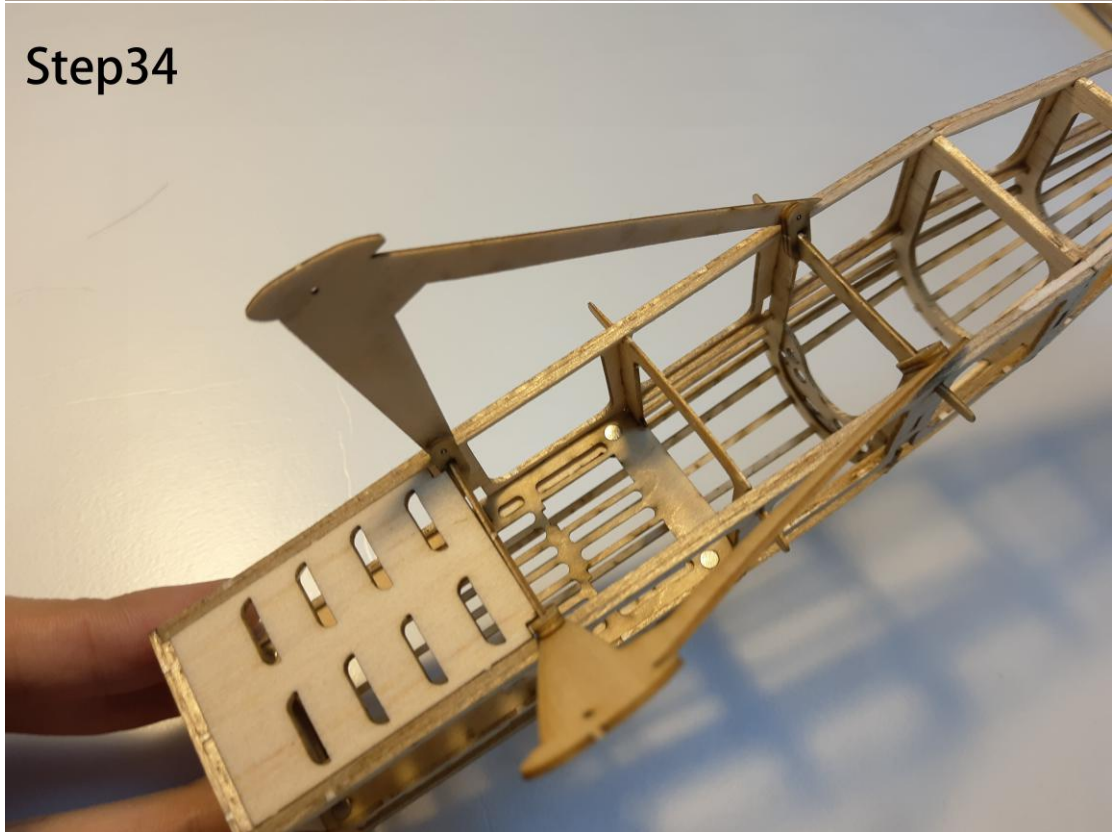

Step35



Step36



Step37



Step38

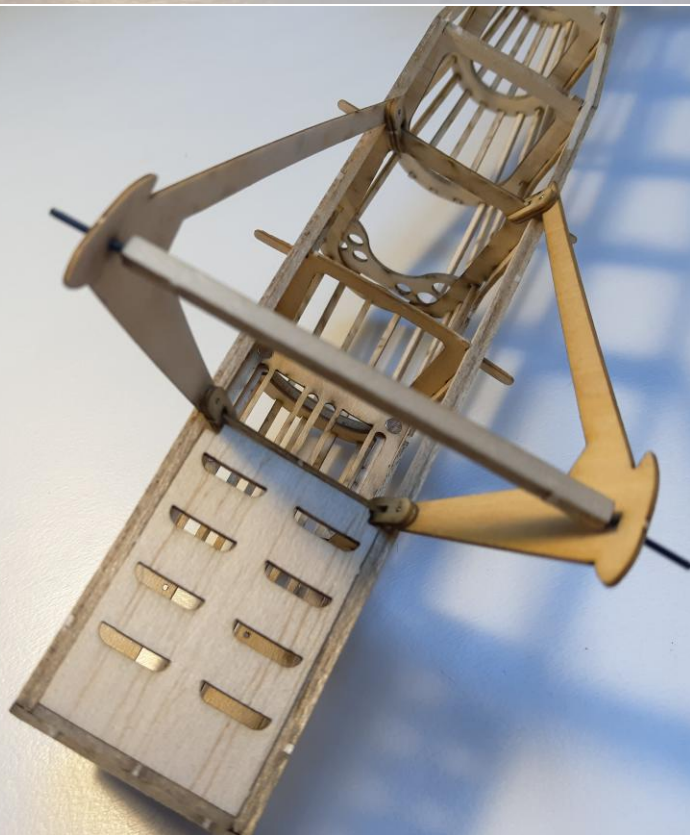

Step39

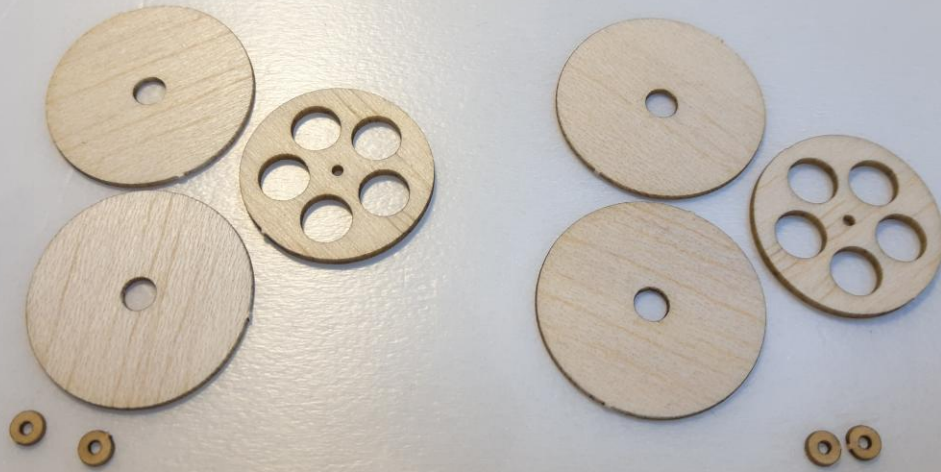

Step40

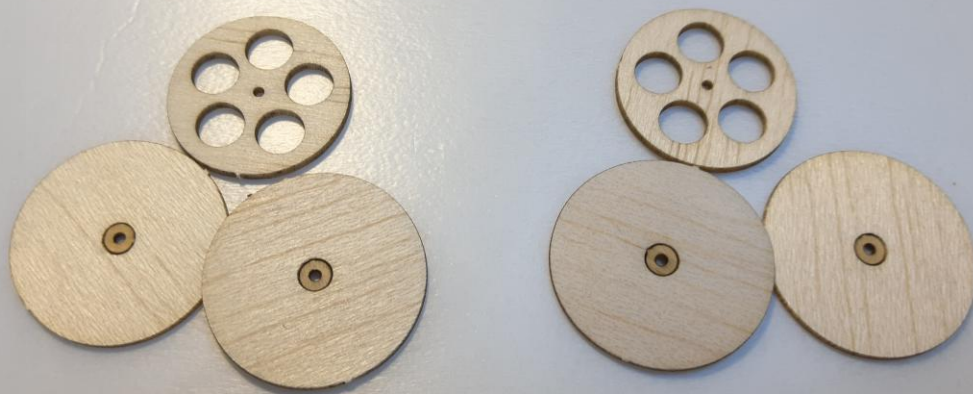

Step41



Step42



Step43



Step44

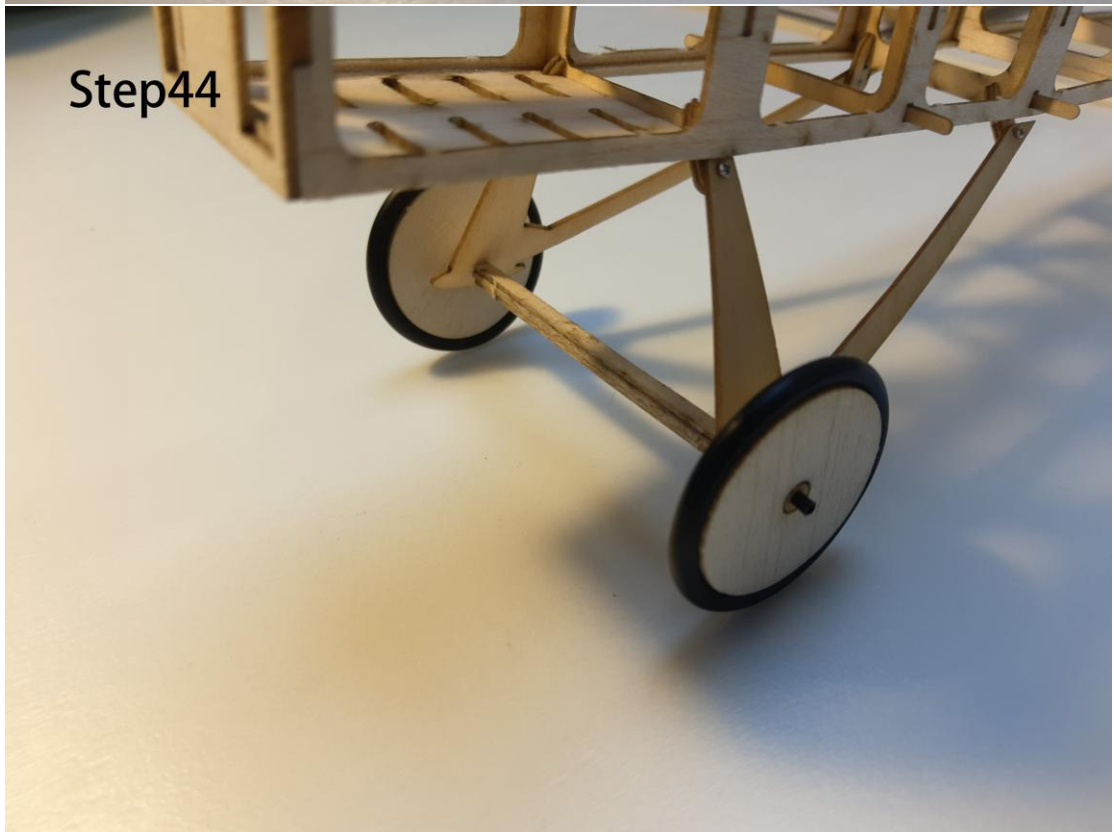

Part2.The wings

Step1

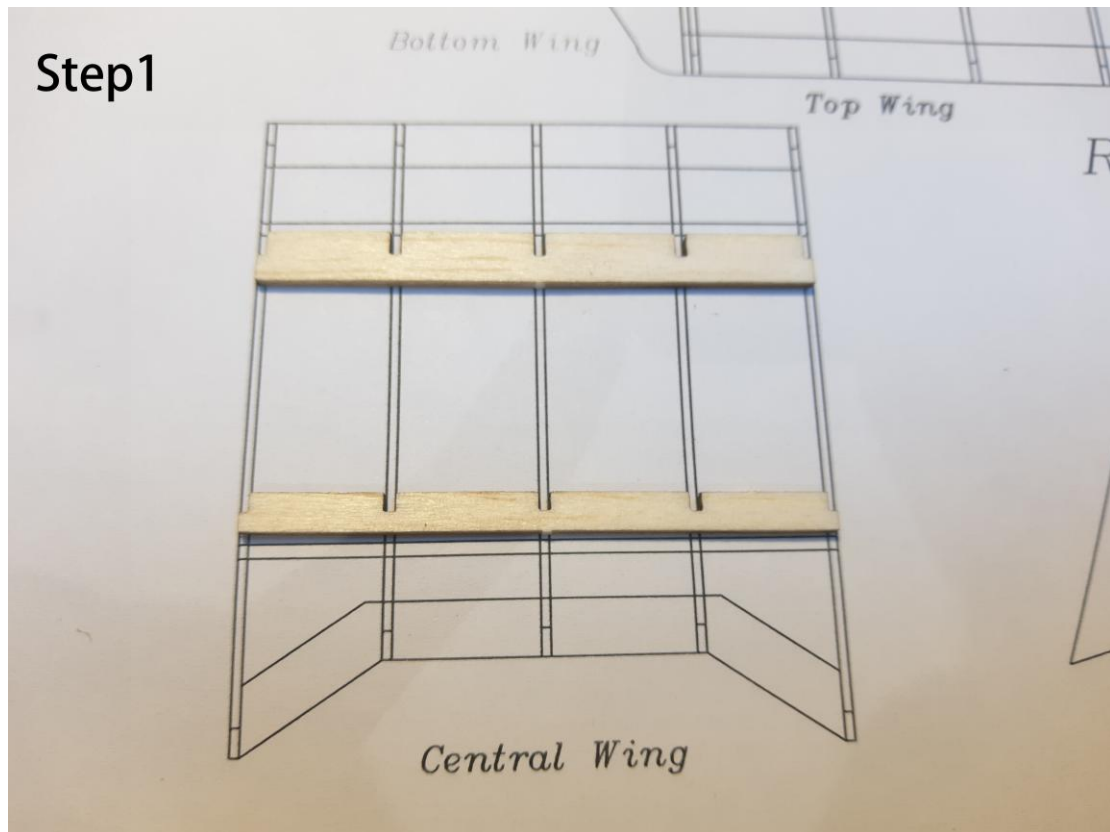

Step2

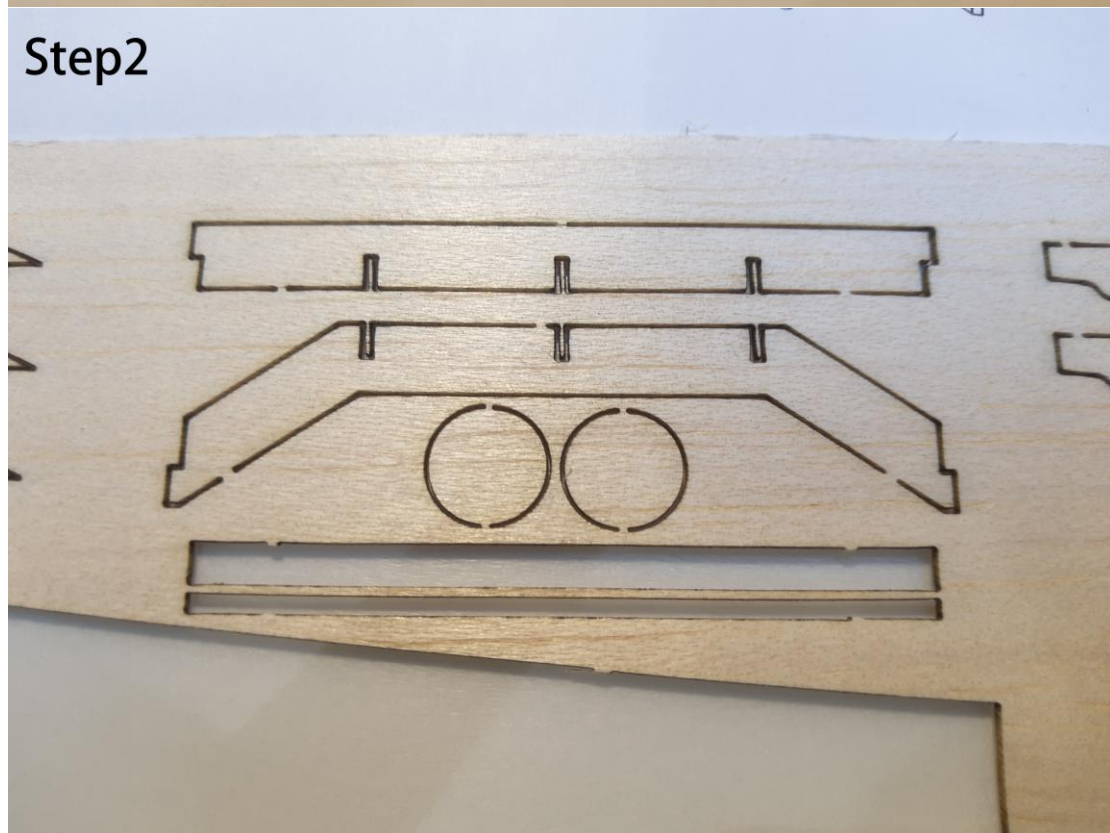

Step3

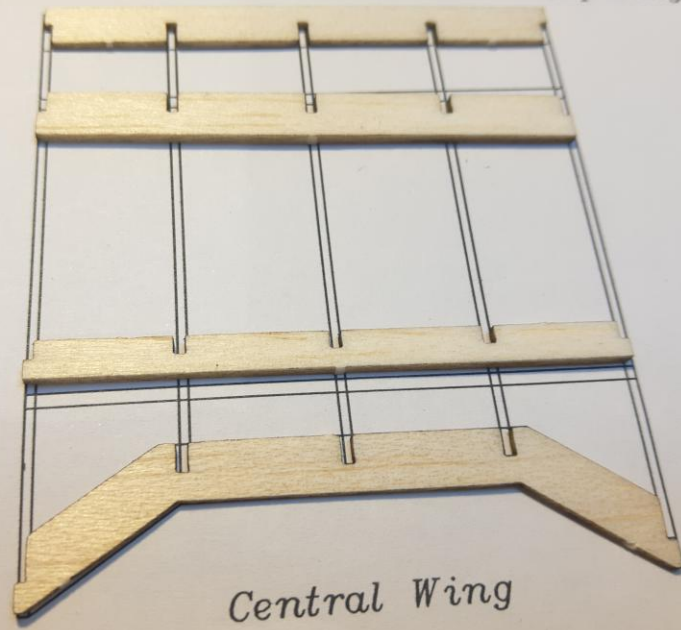

Step4

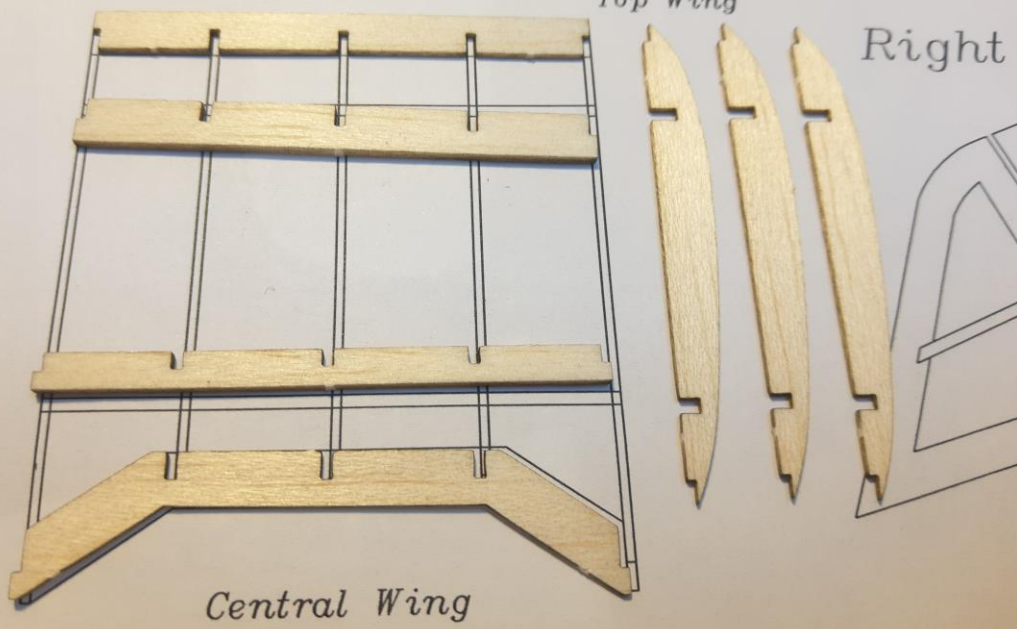

Step5

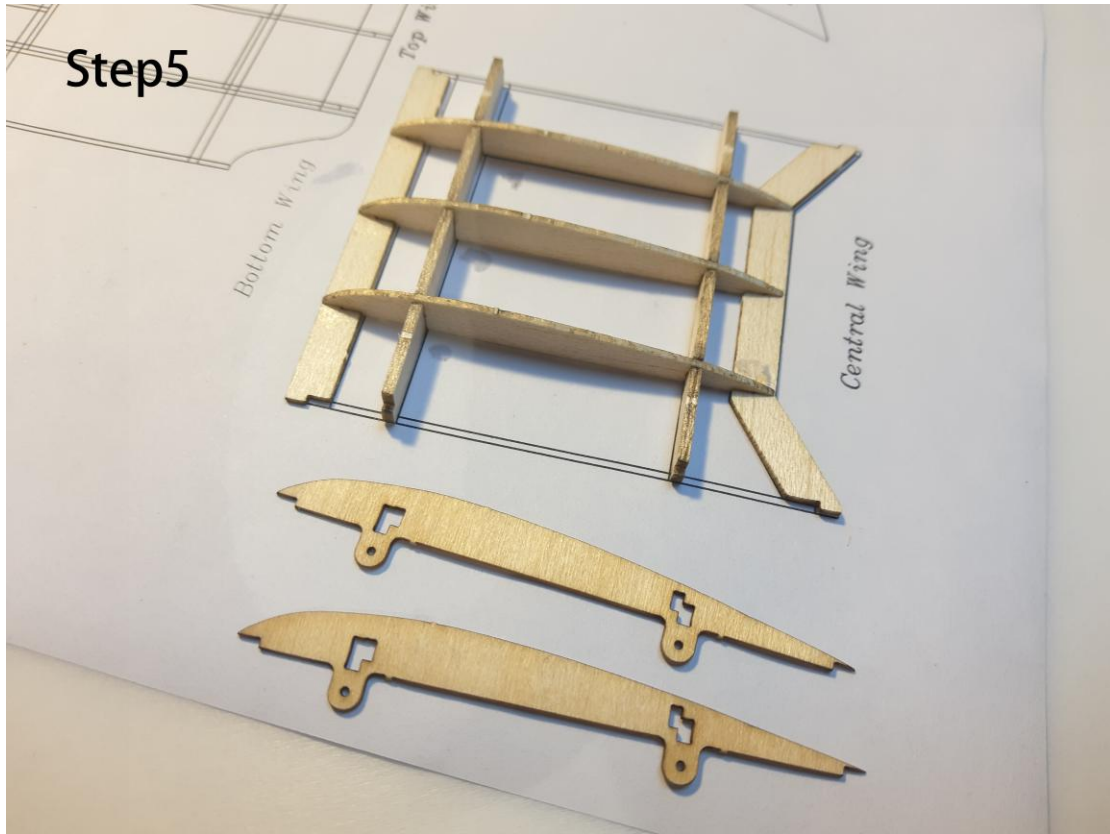

Step6

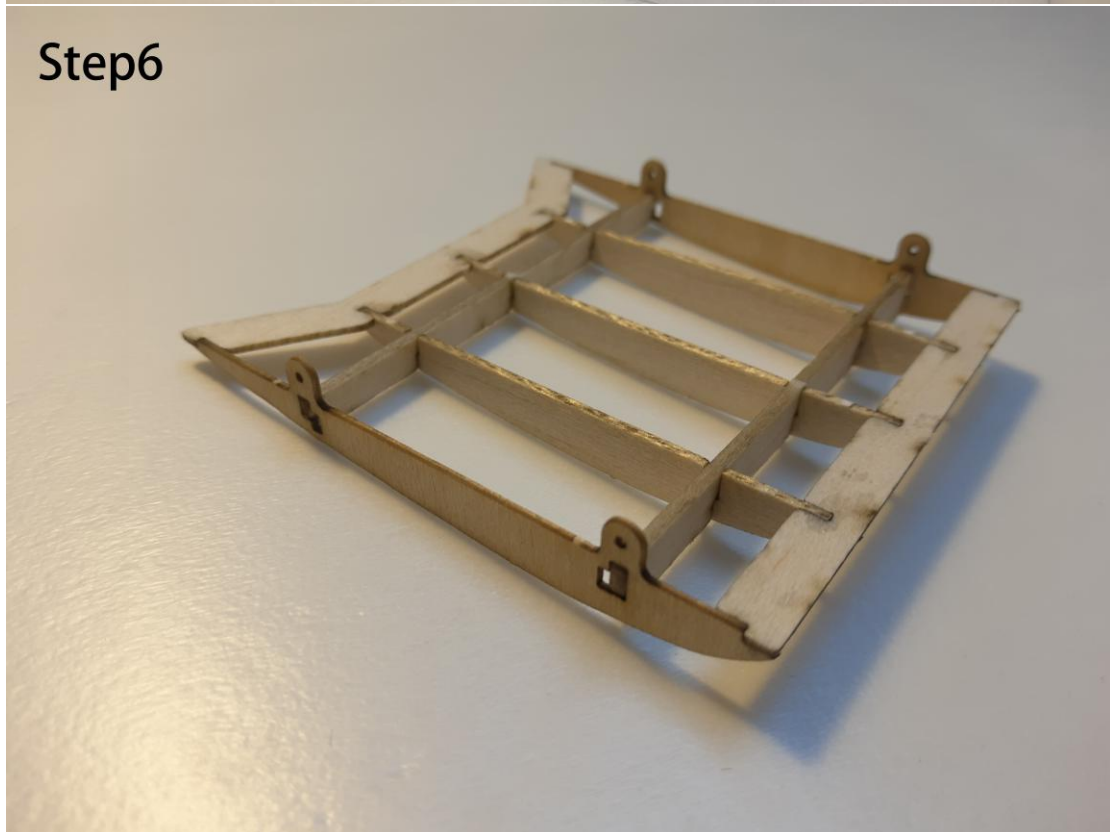

Step7



Step8

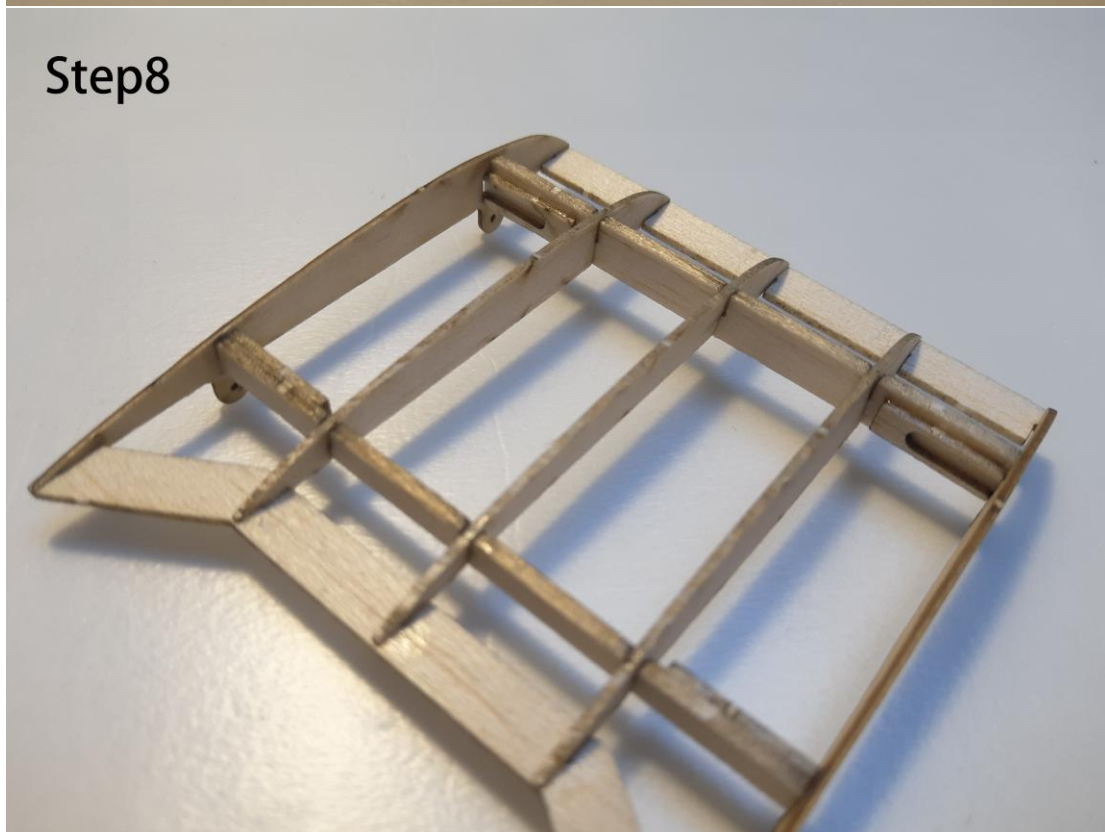

Step9

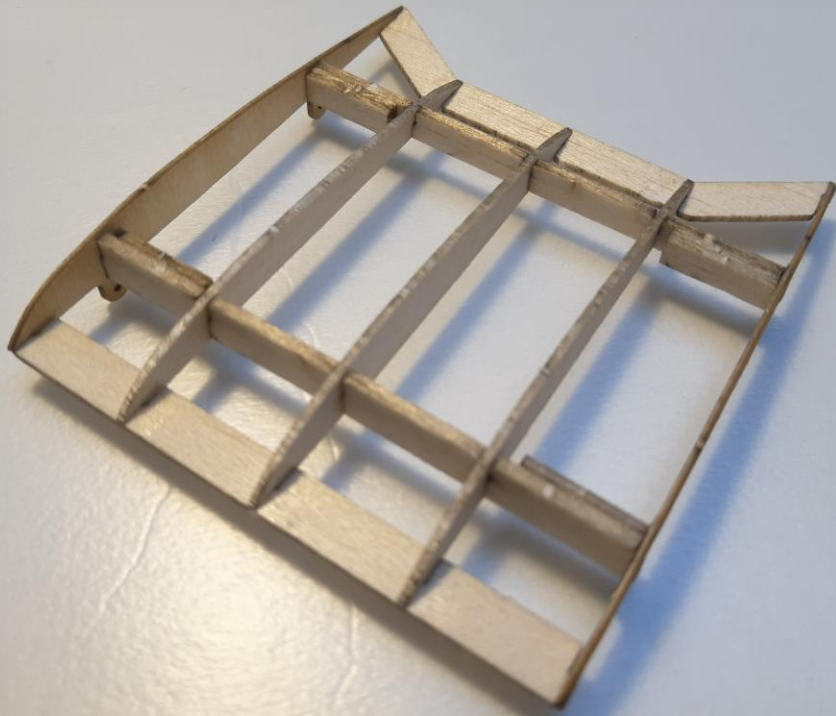

Step10

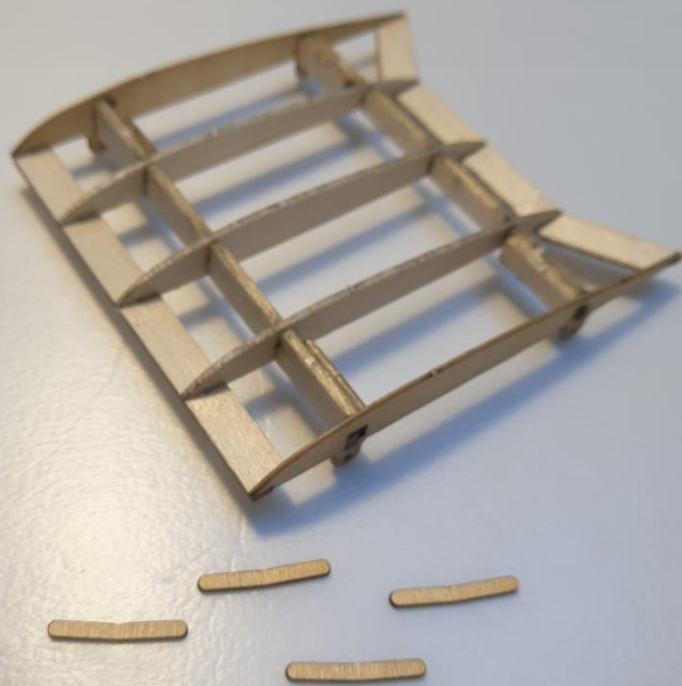

Step11

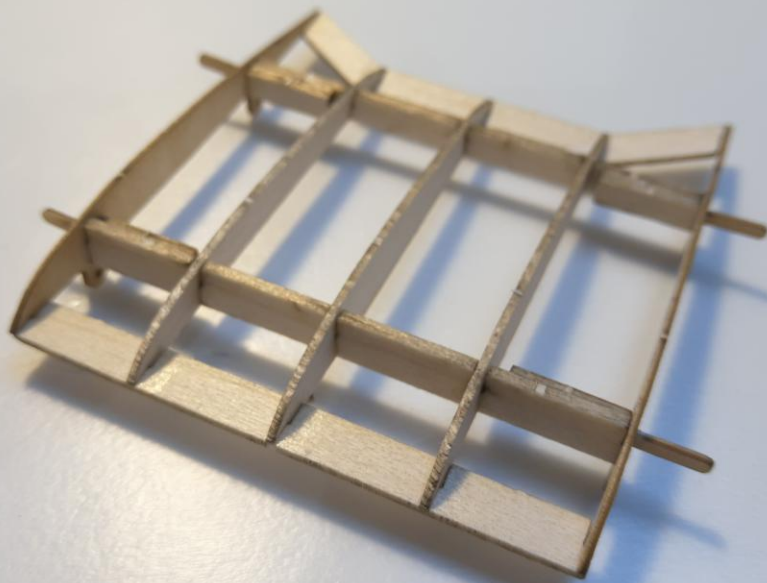

Step12

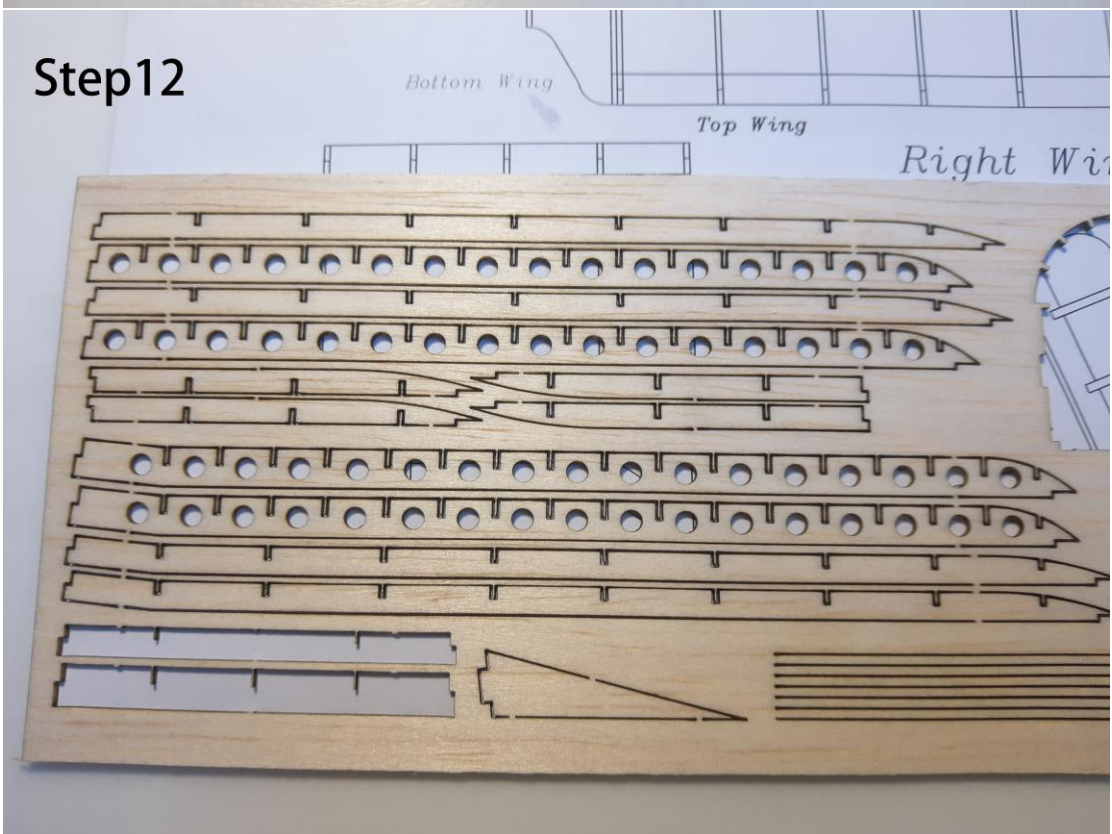

Step13

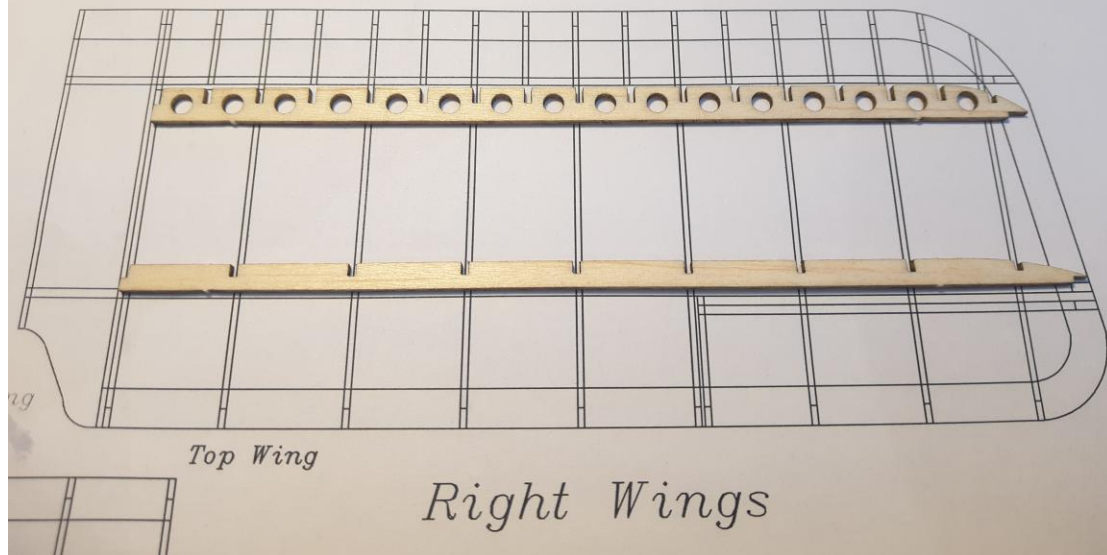

Step14

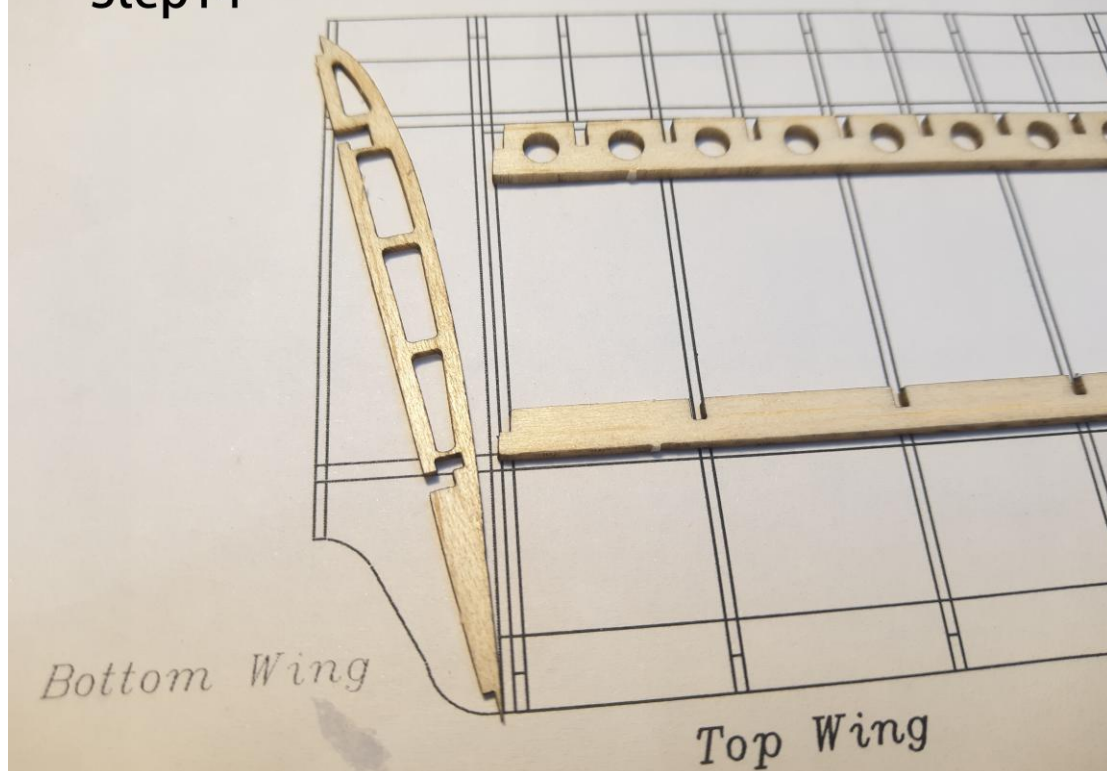

Step15

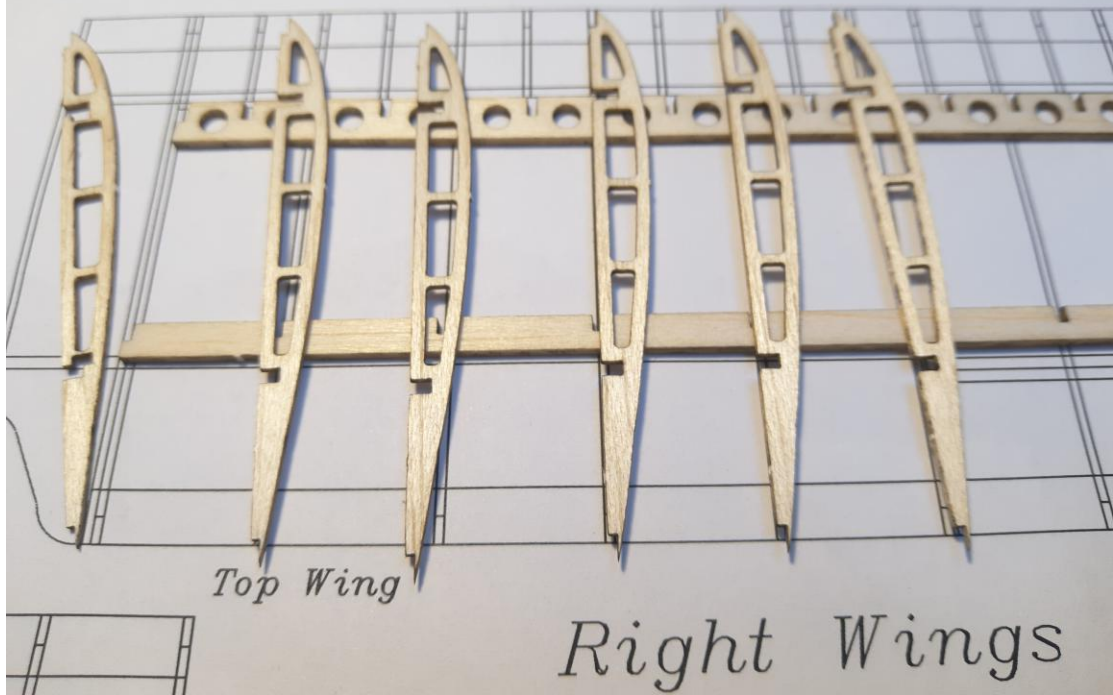

Step16

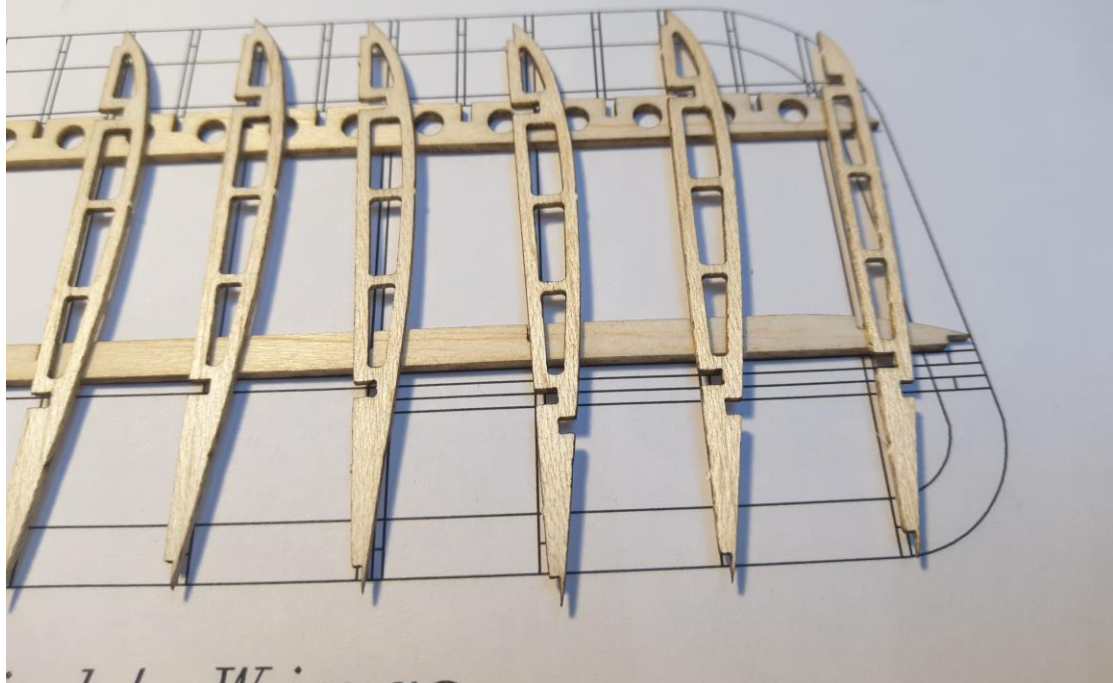

Step17

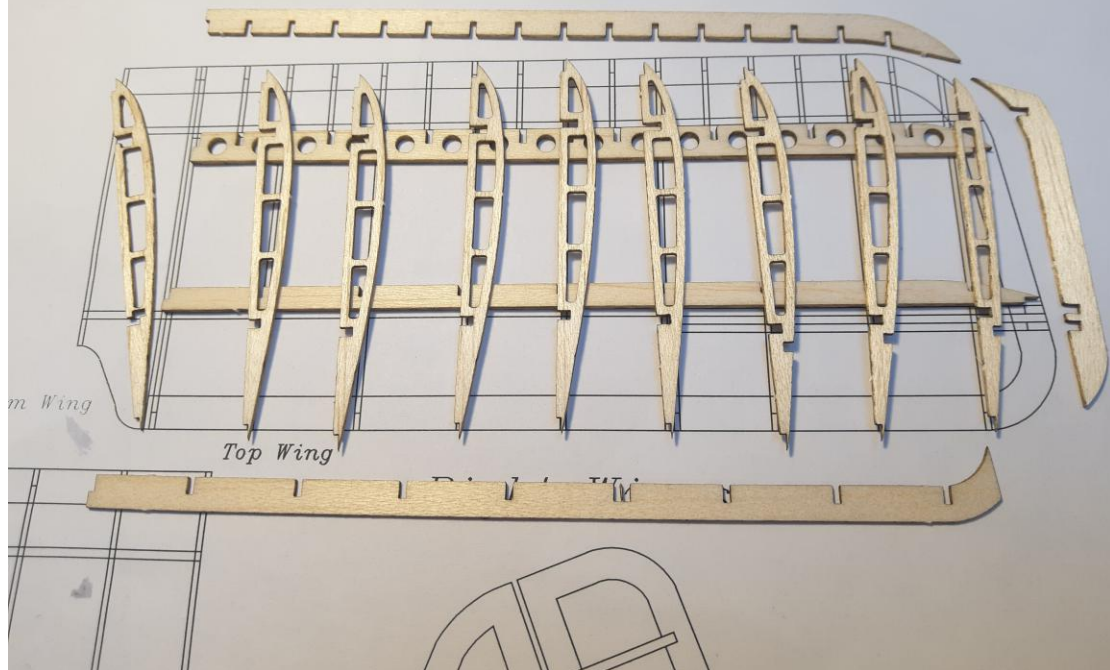

Step18

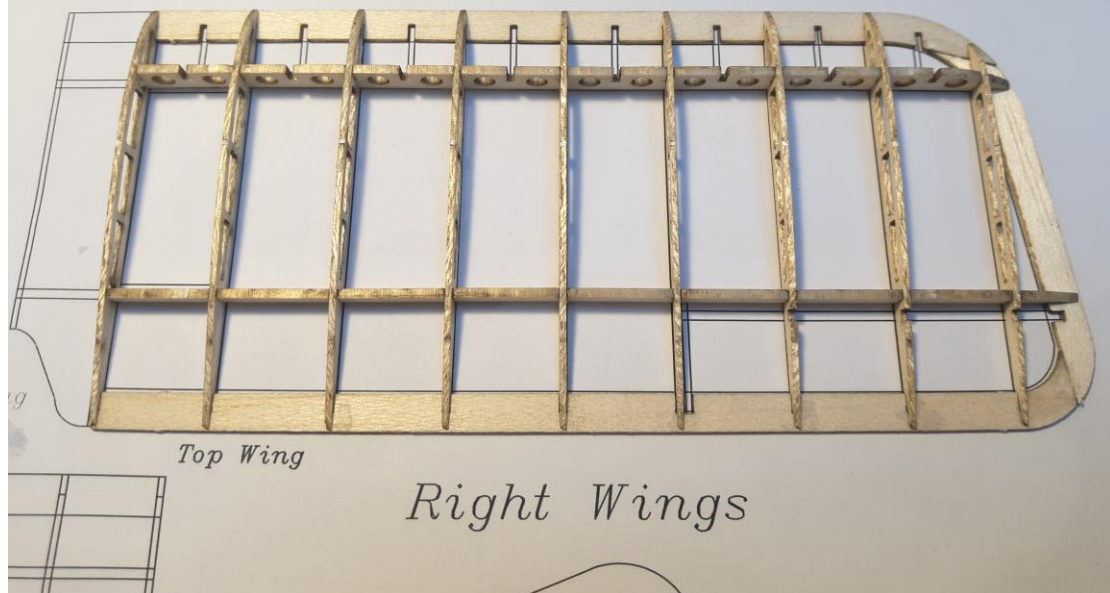

Step19

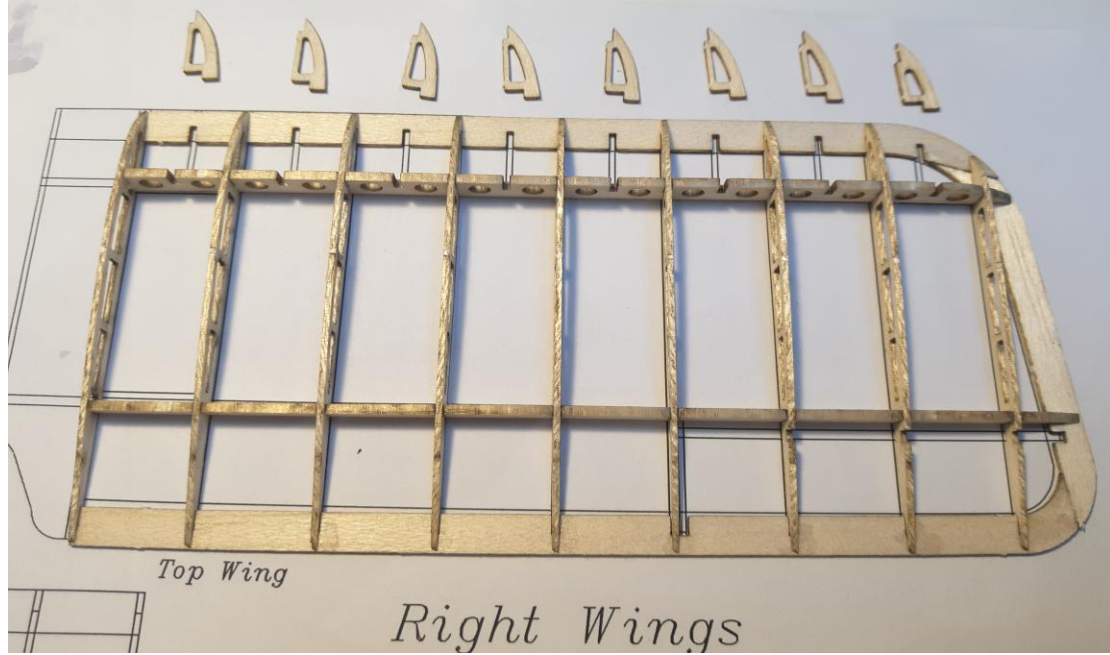

Step20

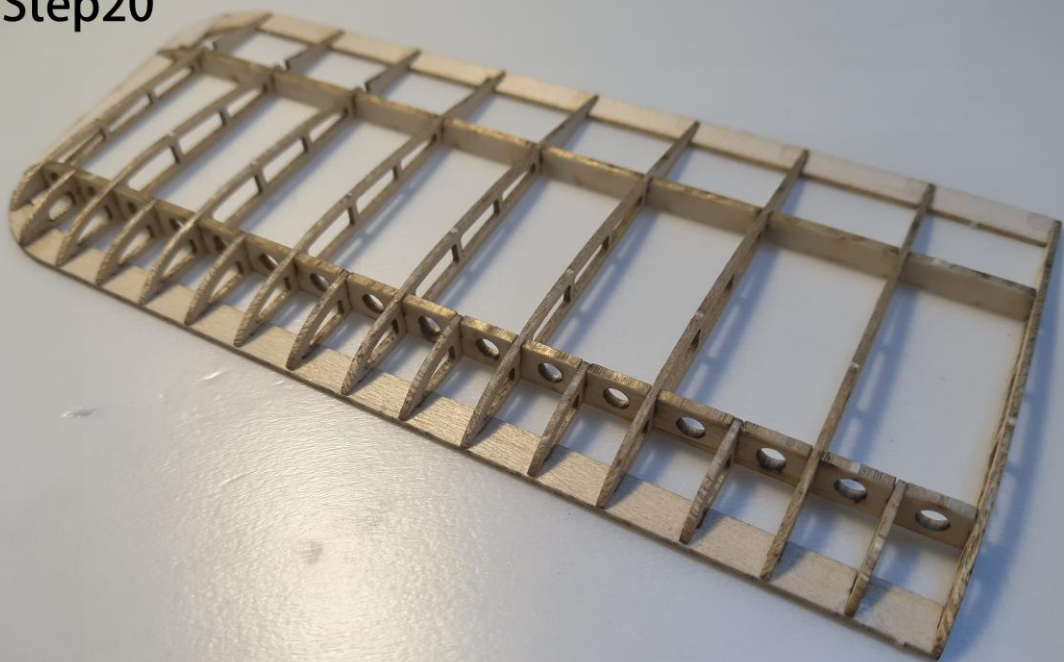

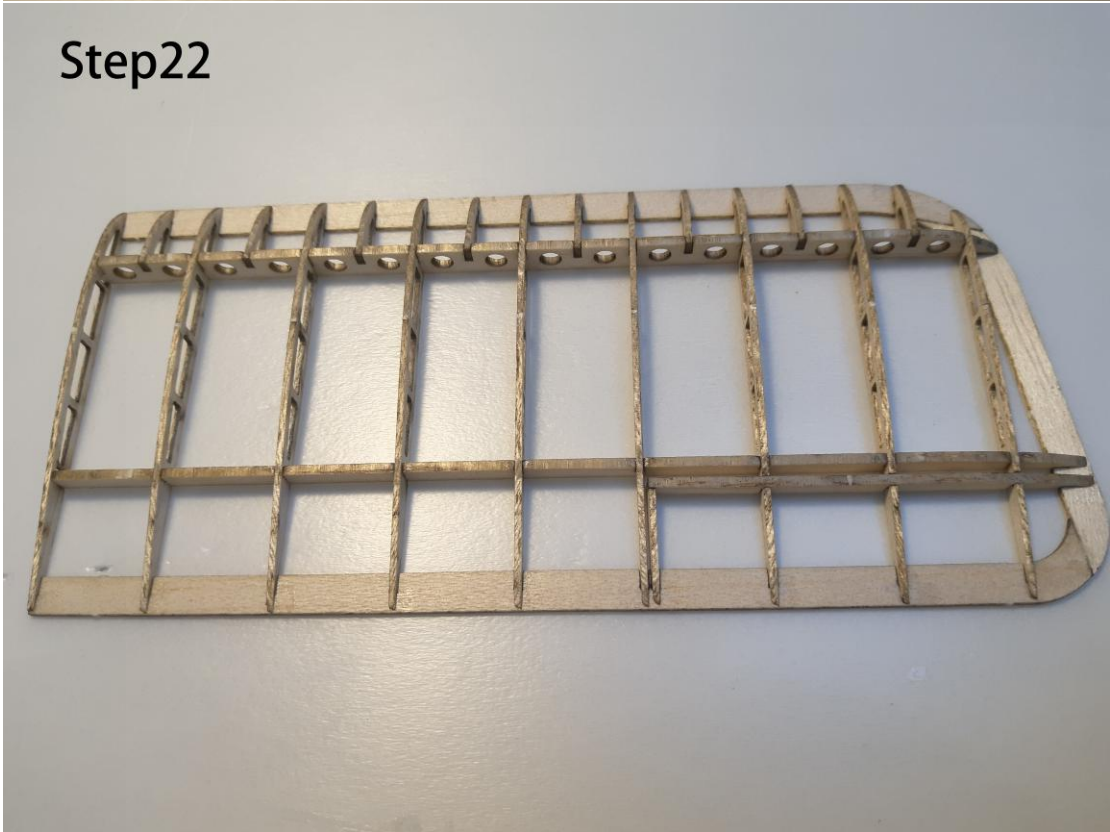
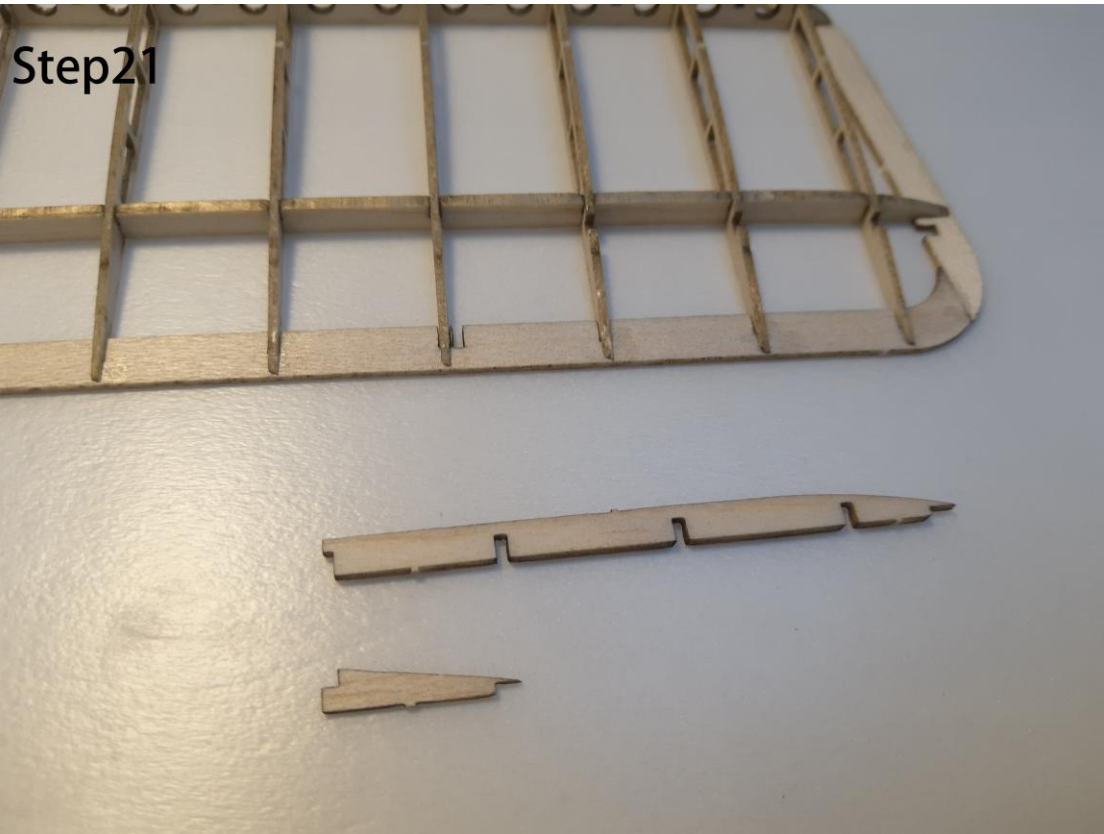

Step23

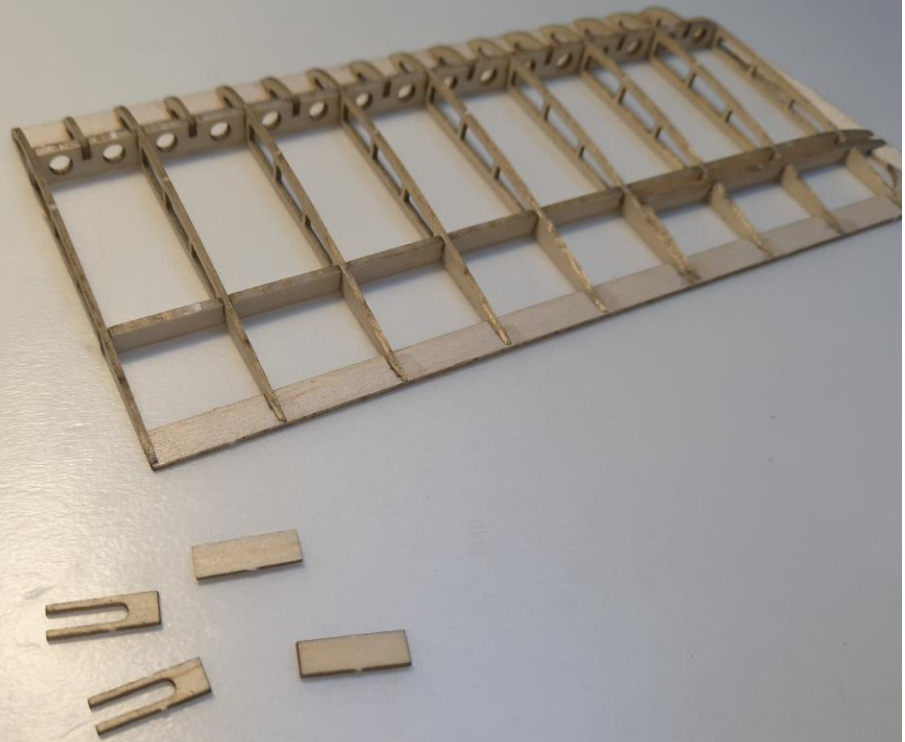

Step24

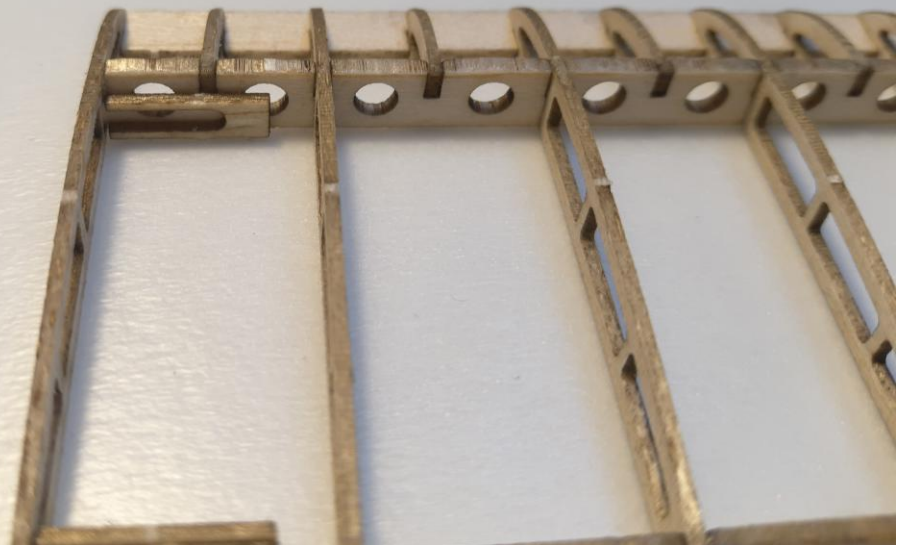

Step25

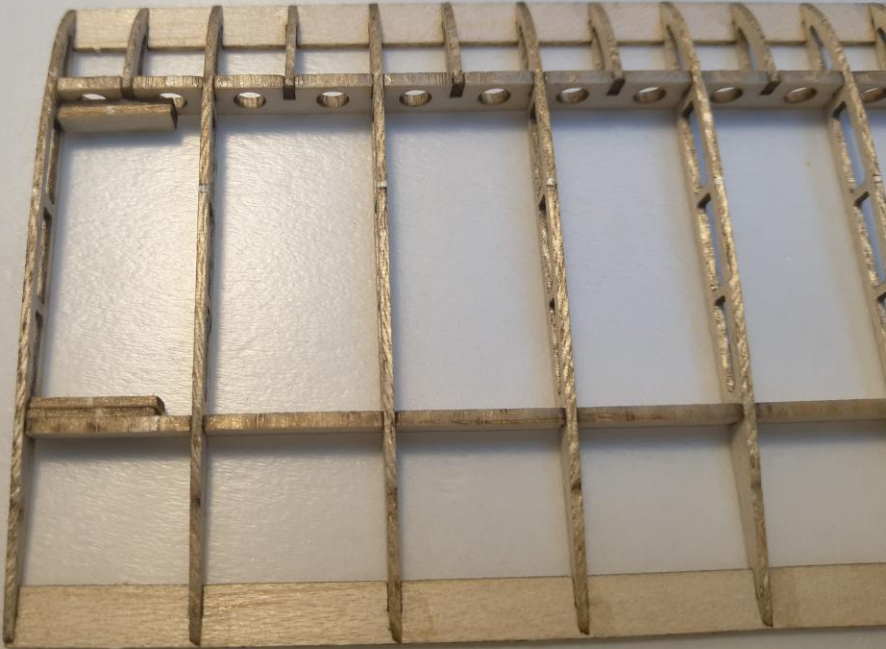

Step26

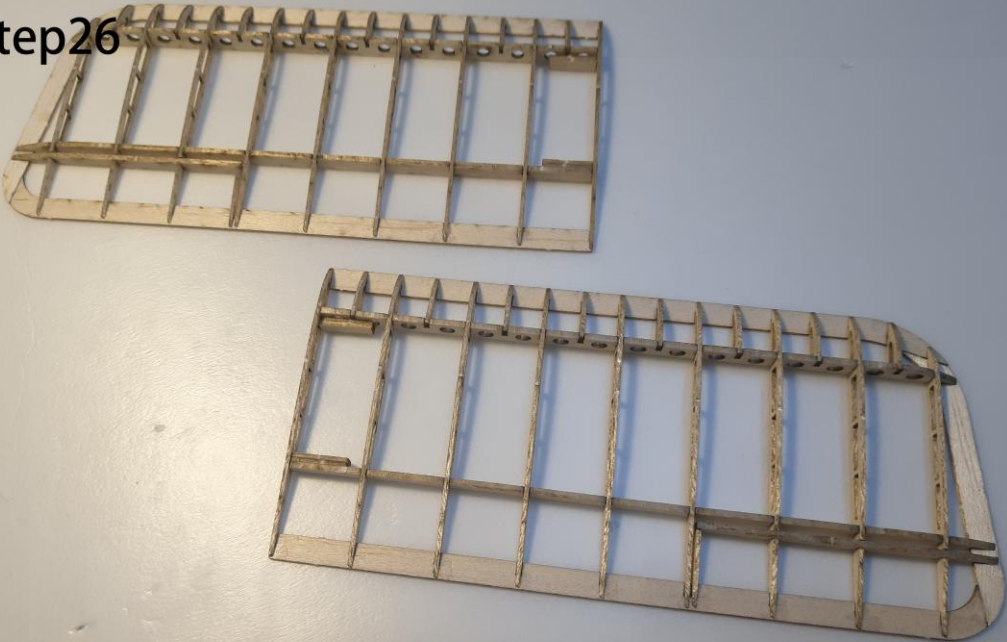

Step27

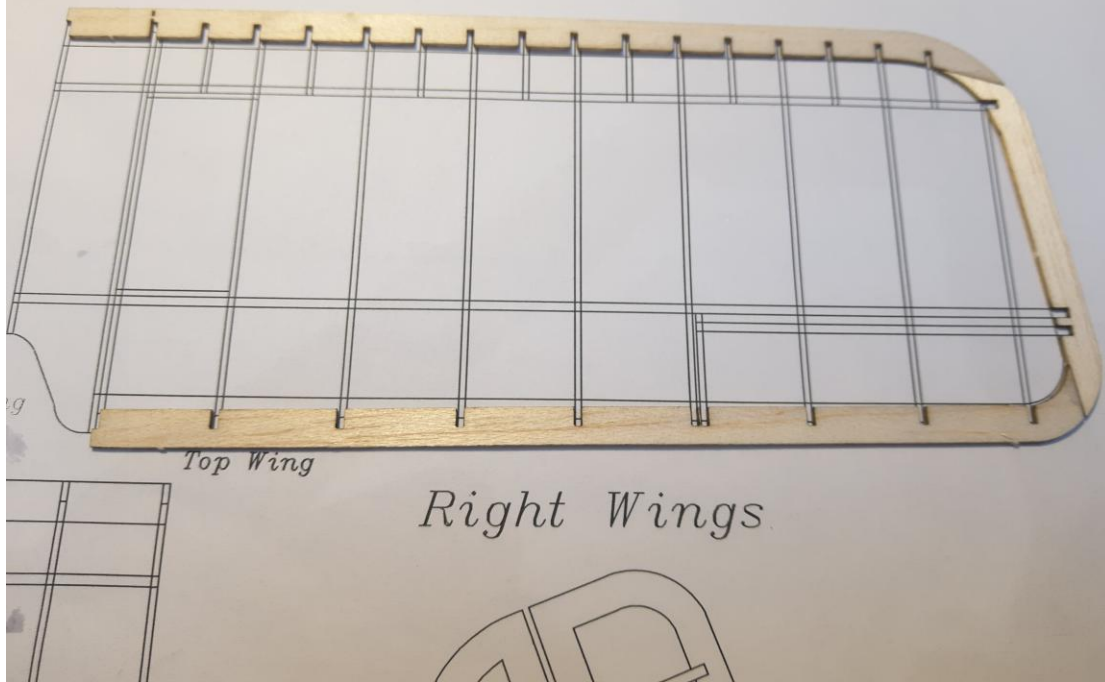

Step28

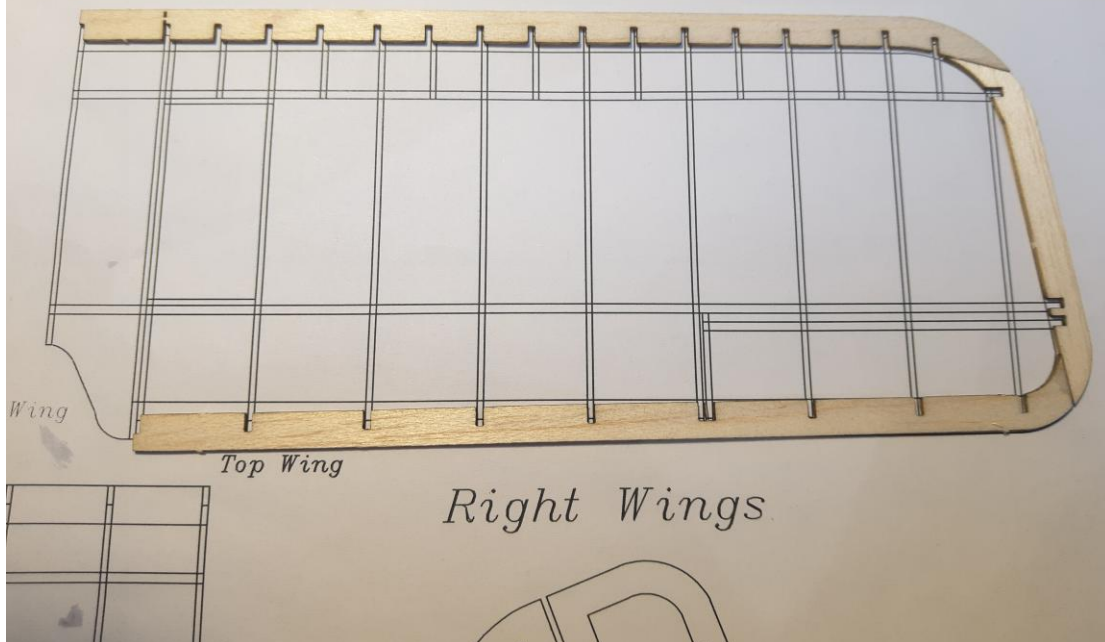

Step29

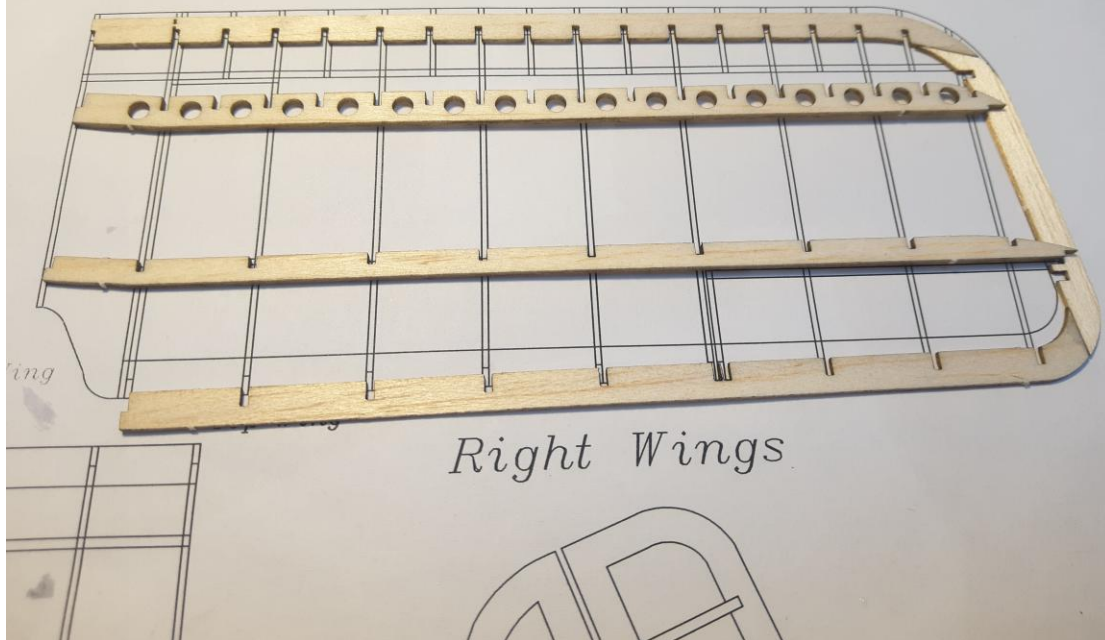

Step30

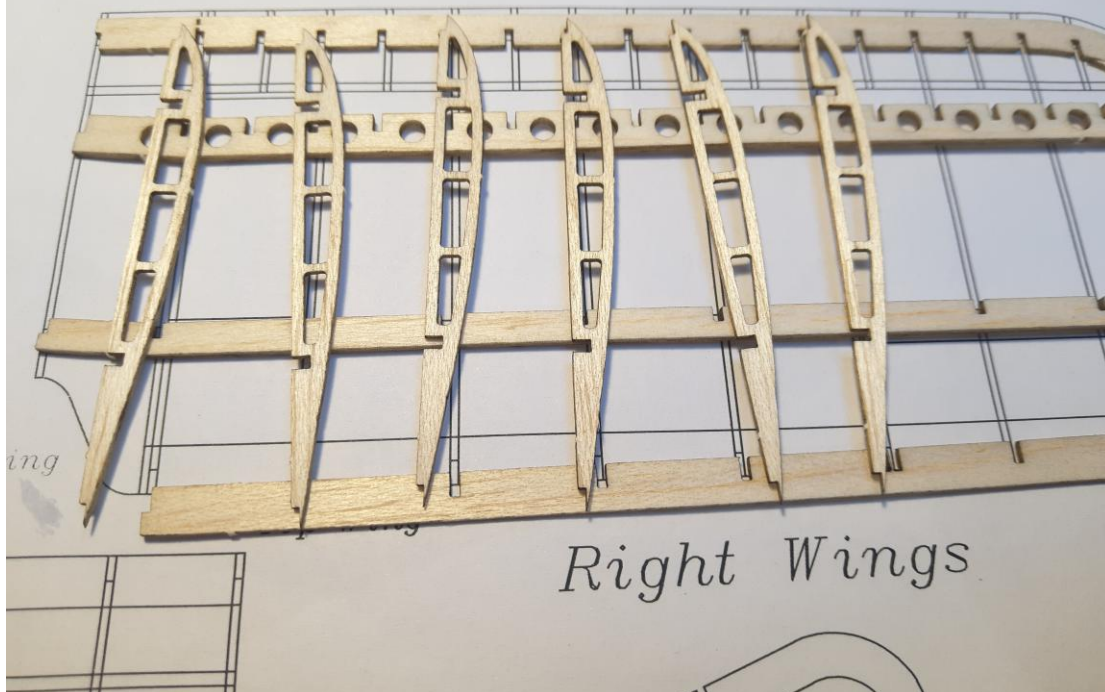

Step31

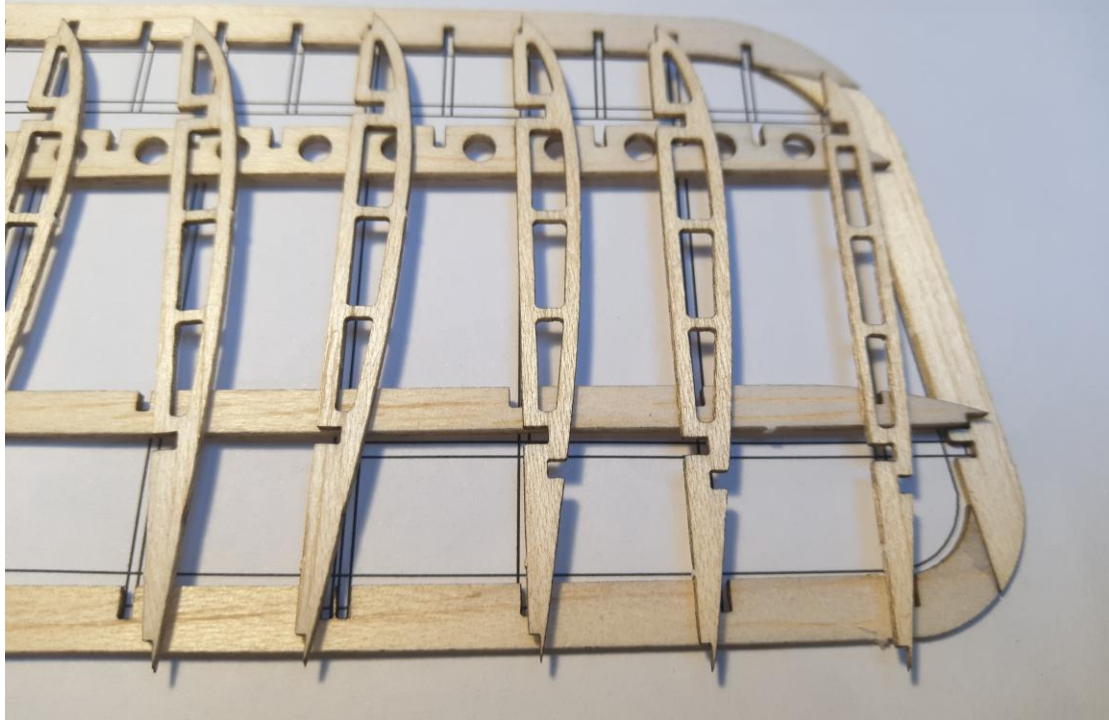

Step32

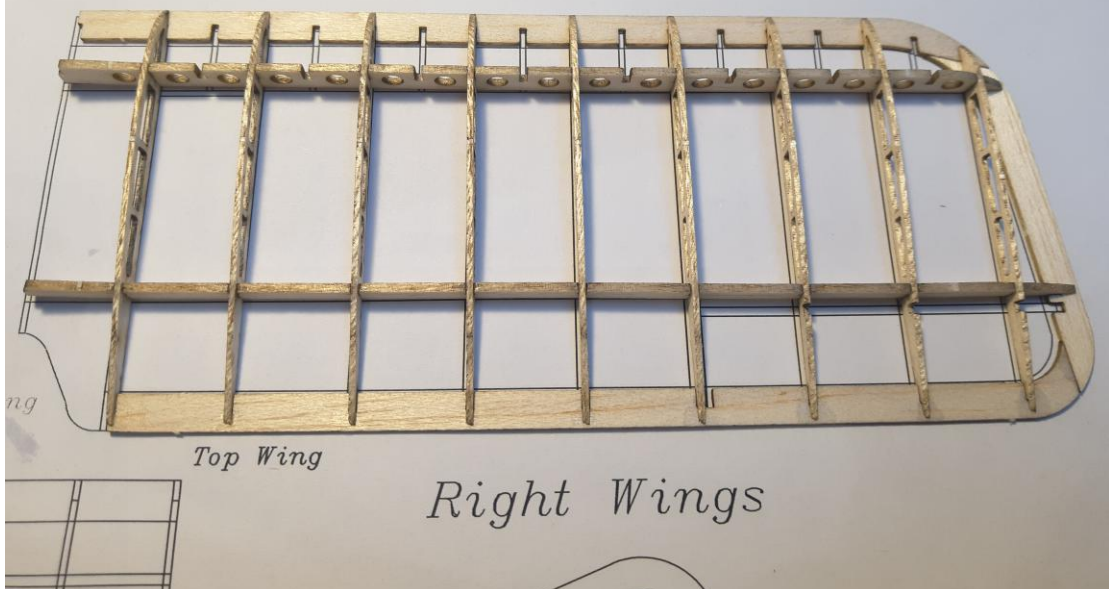

Step33

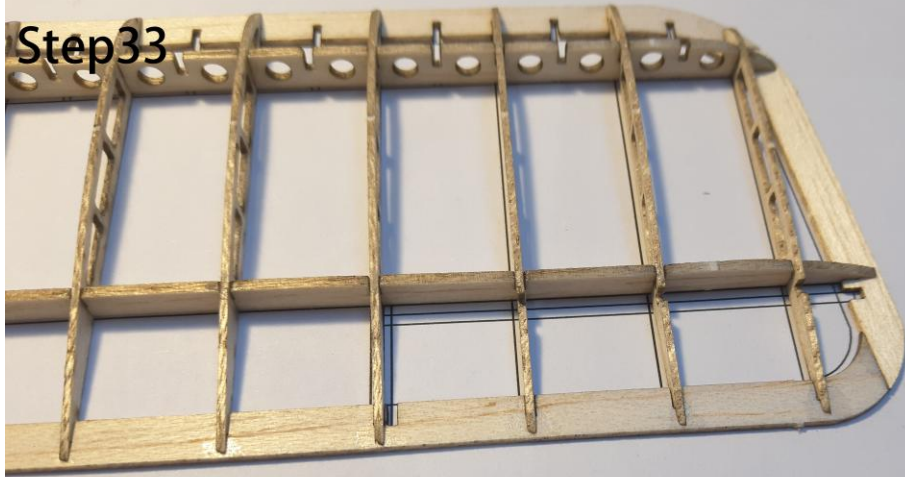

Right Wings

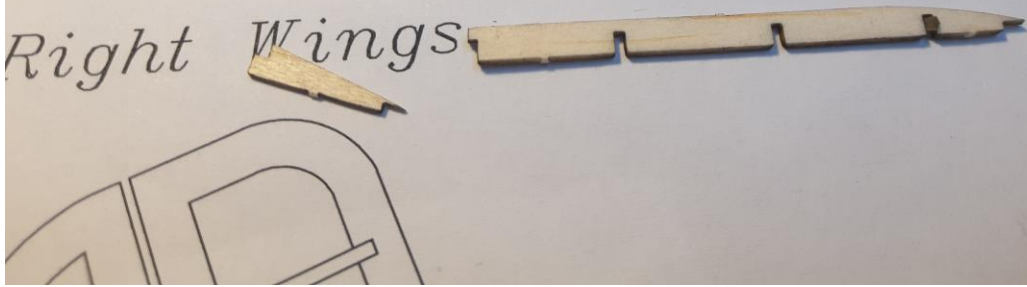

Step34

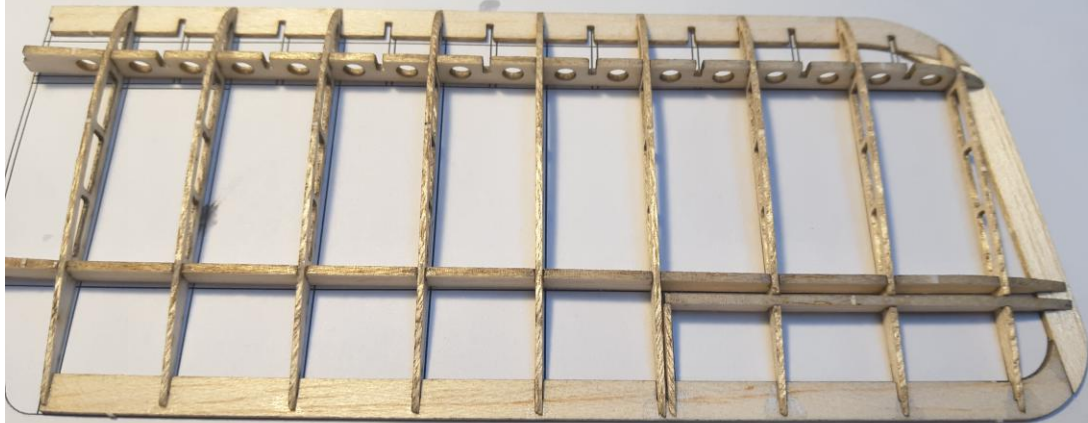

Top Wing

Right Wings

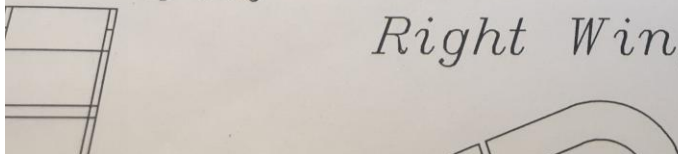

Step35

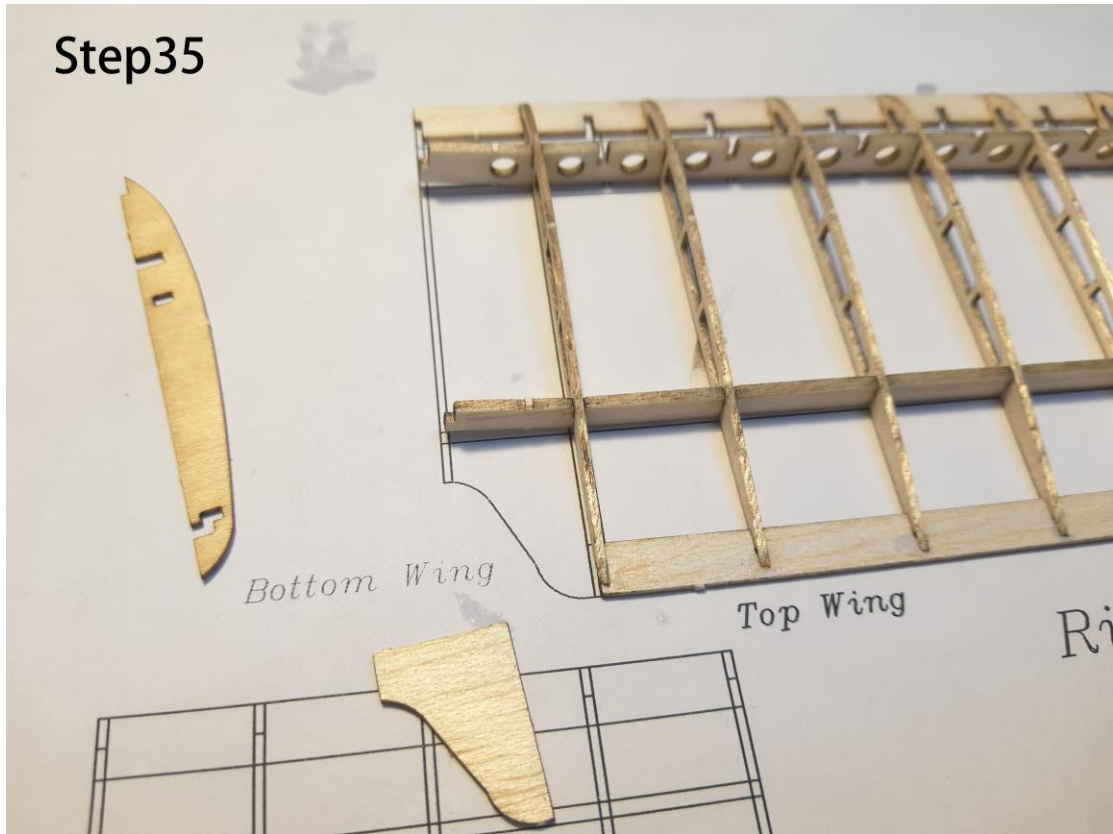

Step36

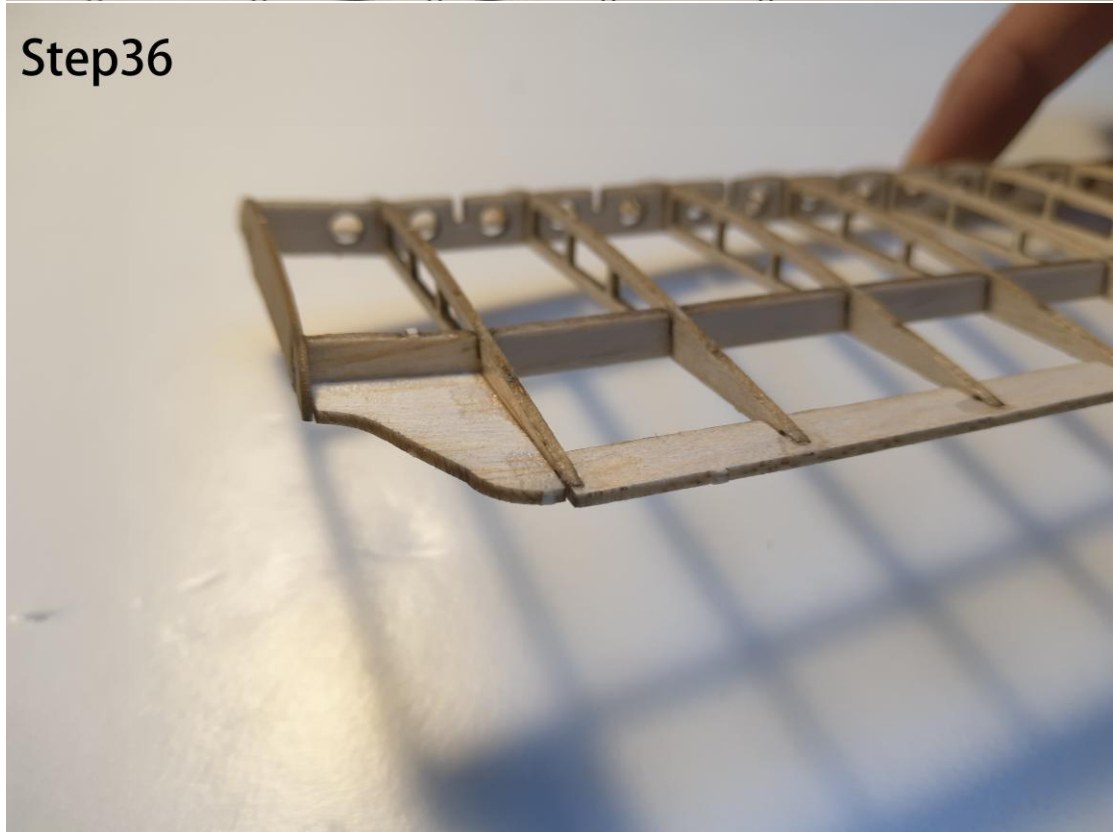

Step37

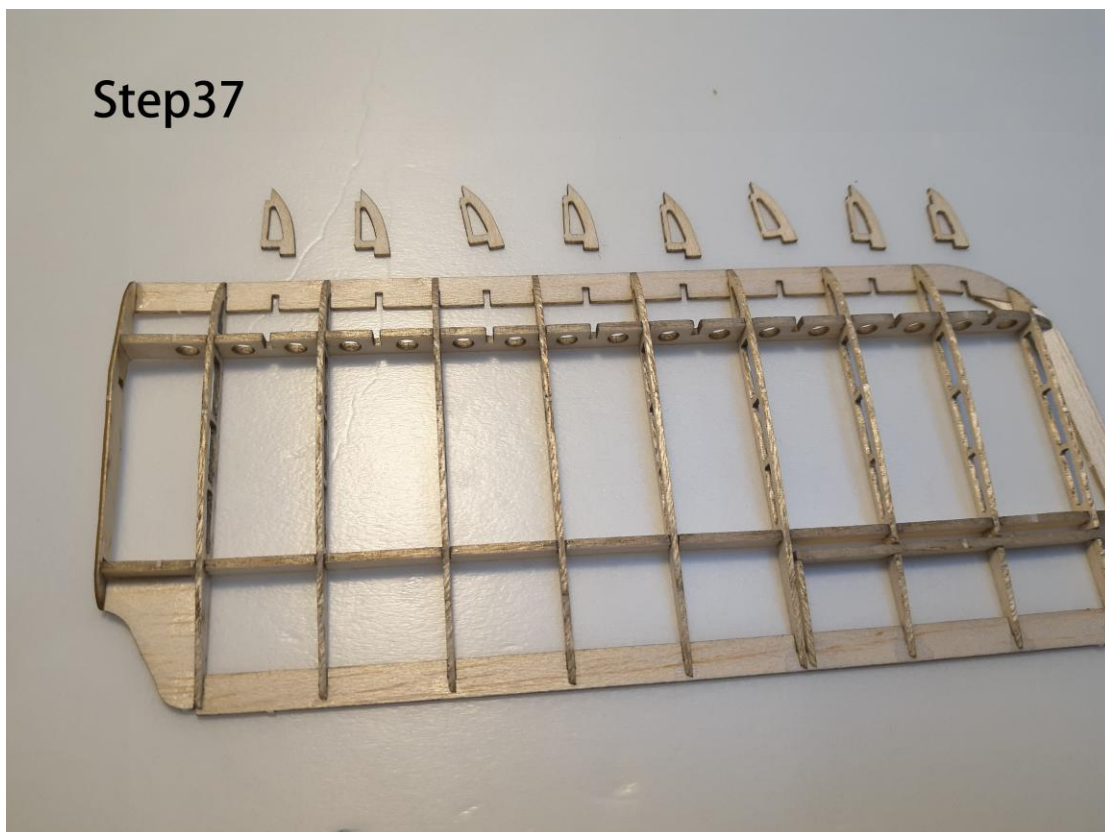

Step38

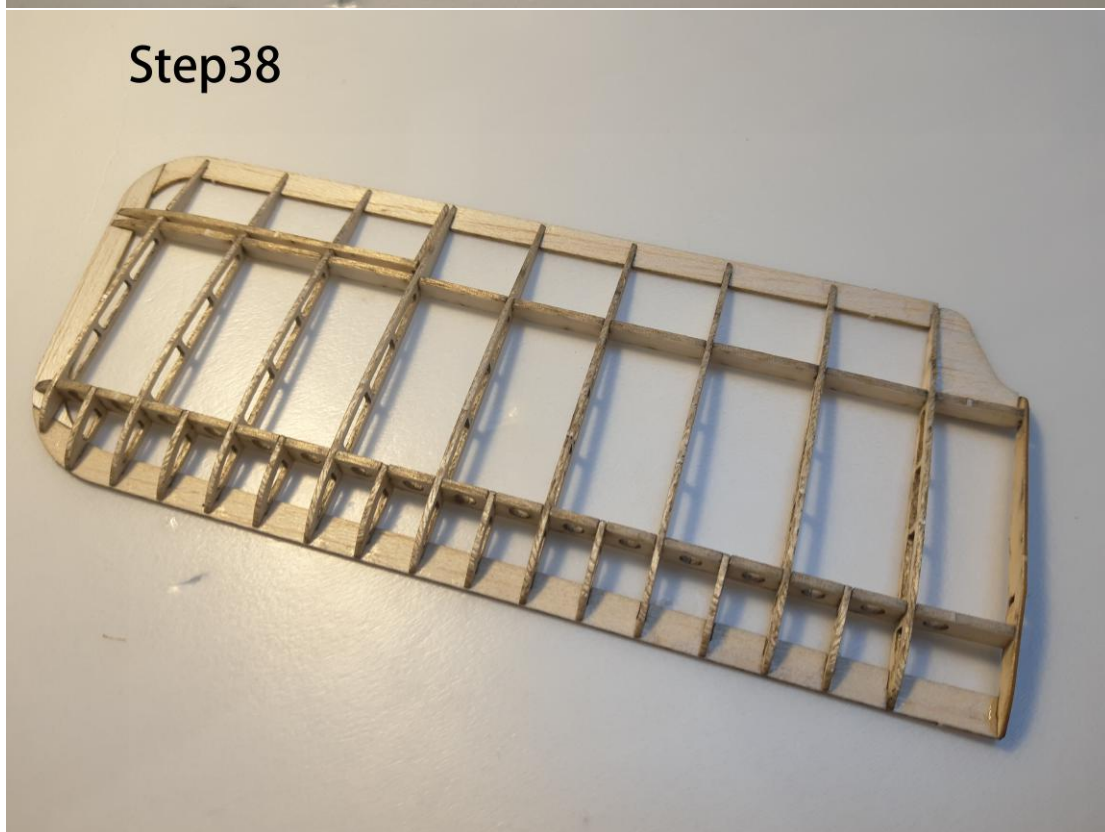

Step39

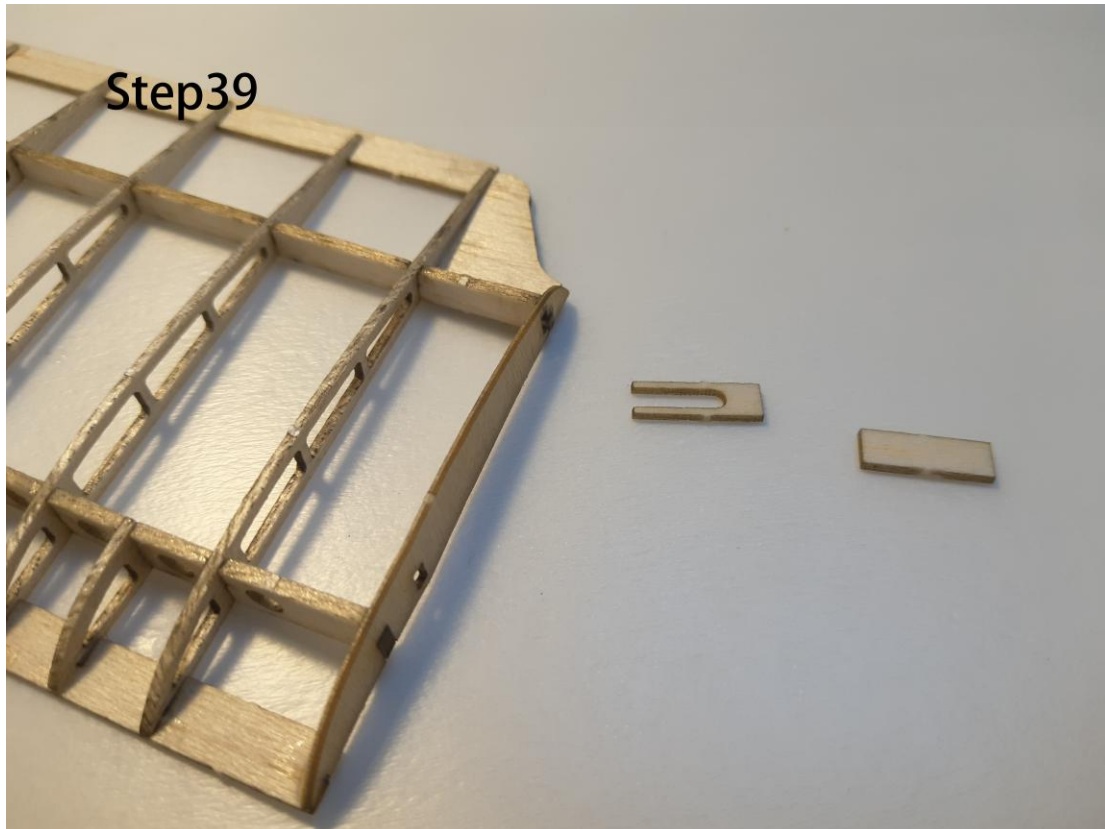

Step40

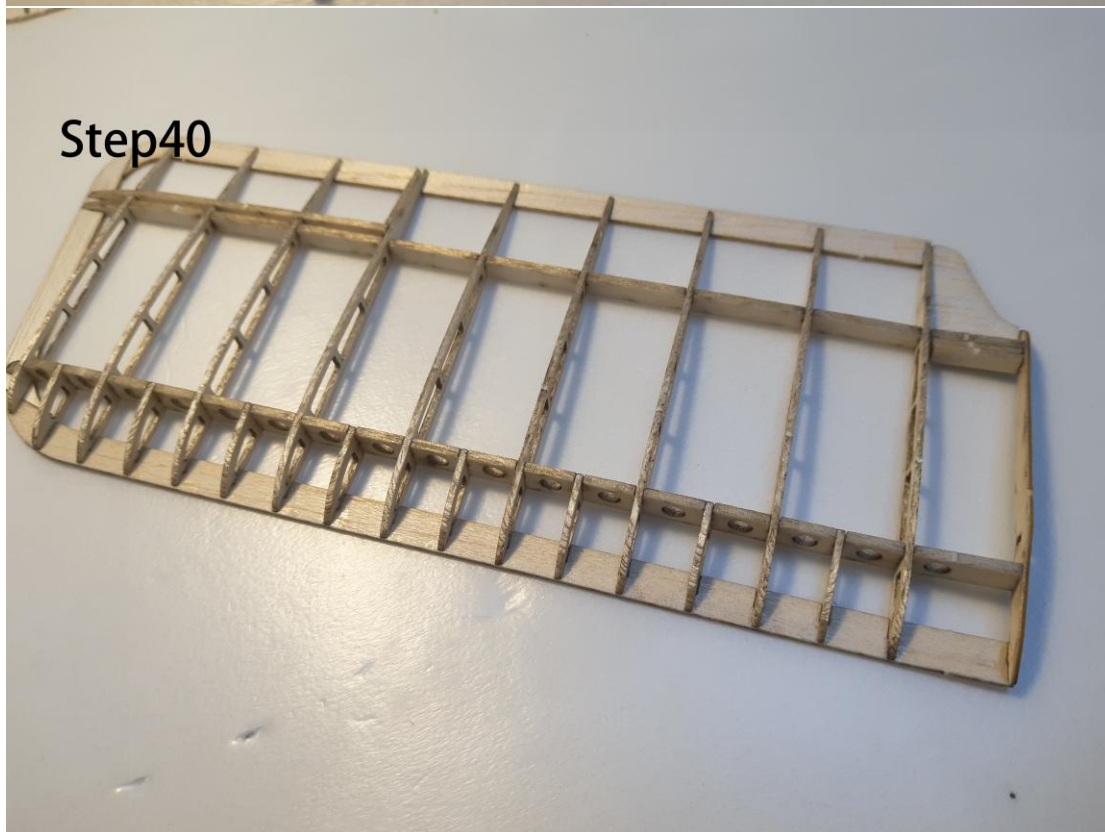

Step41

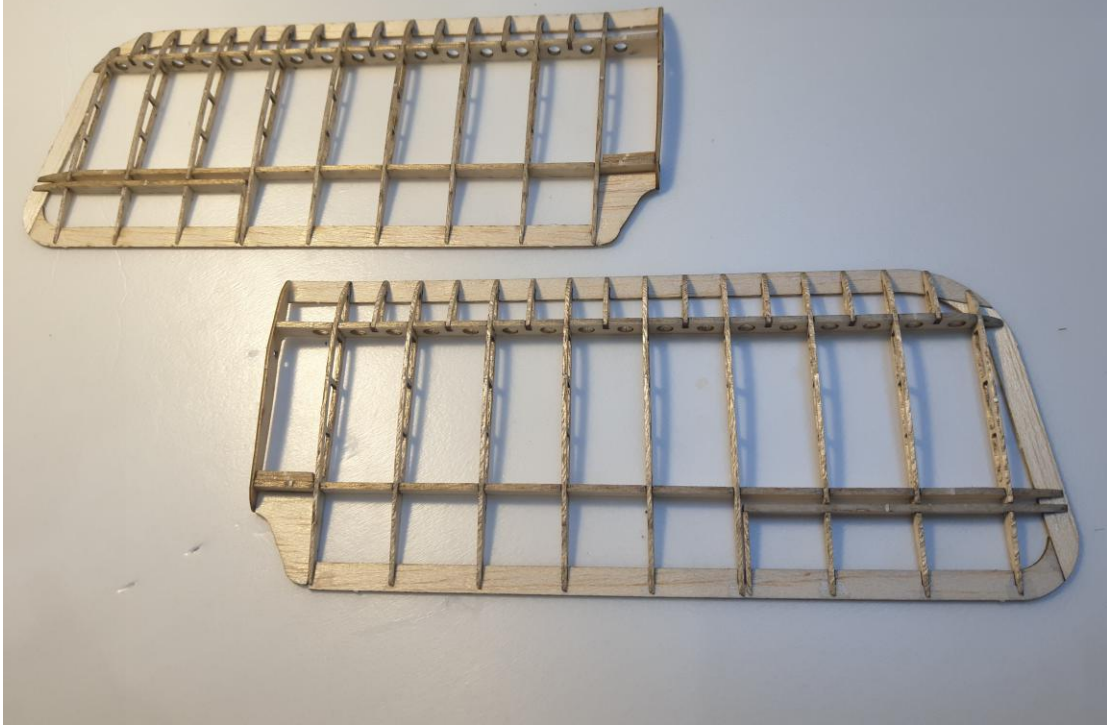

Step42

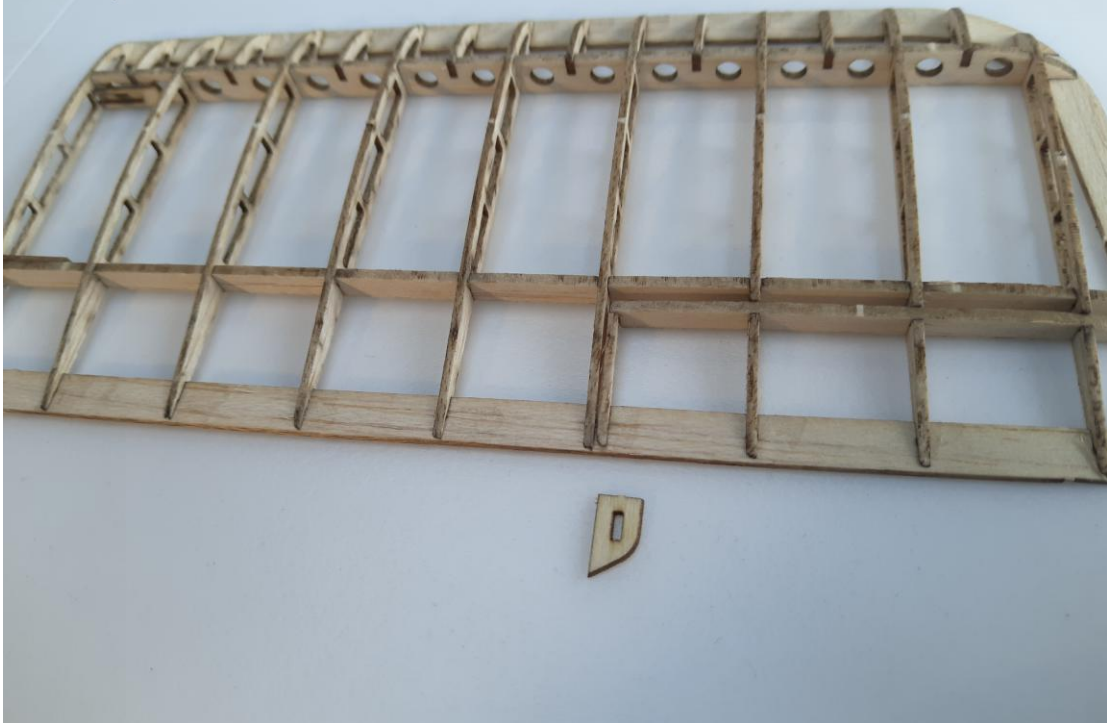

Step43

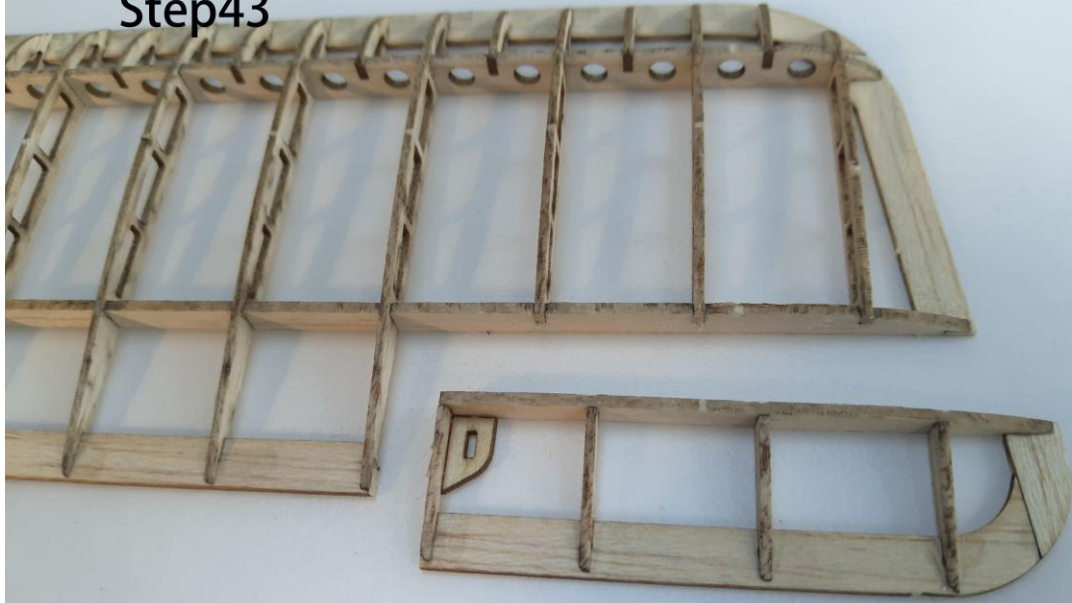

Attention: This plane suitable for both 3ch and 4ch flying, if you prefer to 3ch flying, please don't cut off the aileron.

Step44



Step45



Step46



Step47



Step48

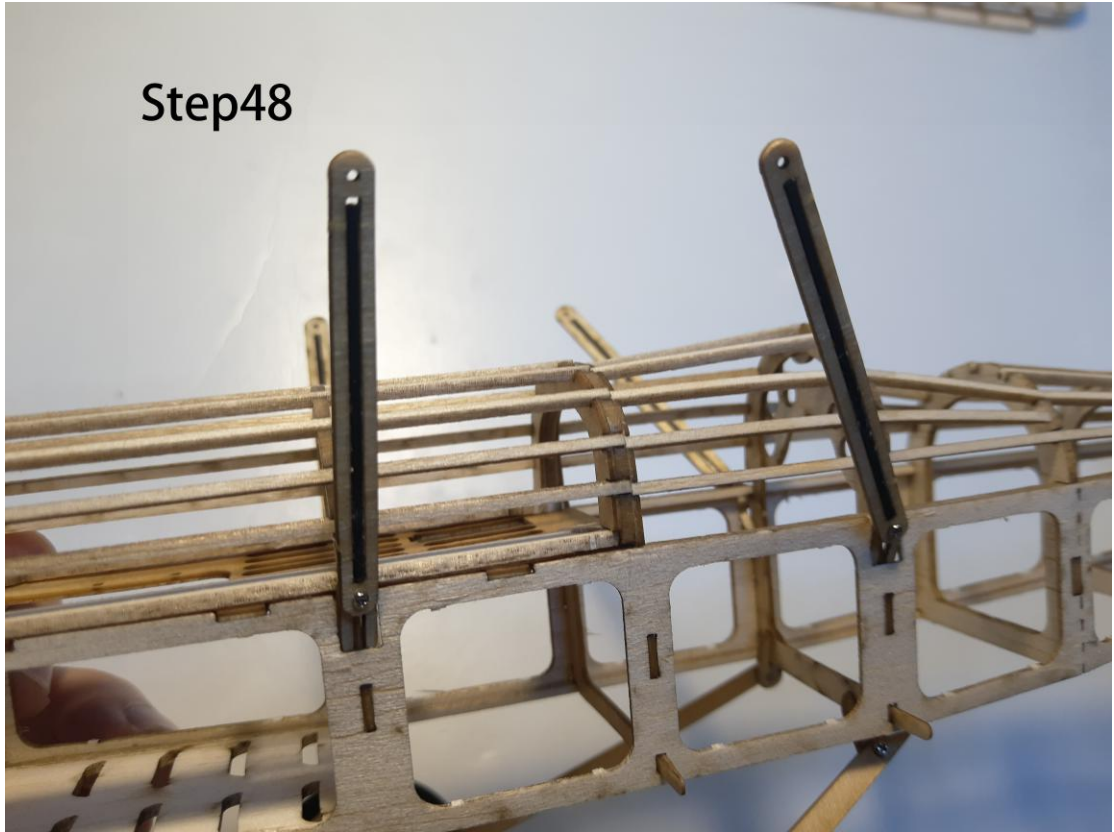

Step49



Step50



Part3. Accessories

Step1



Step2



Step3



Step4



Step5

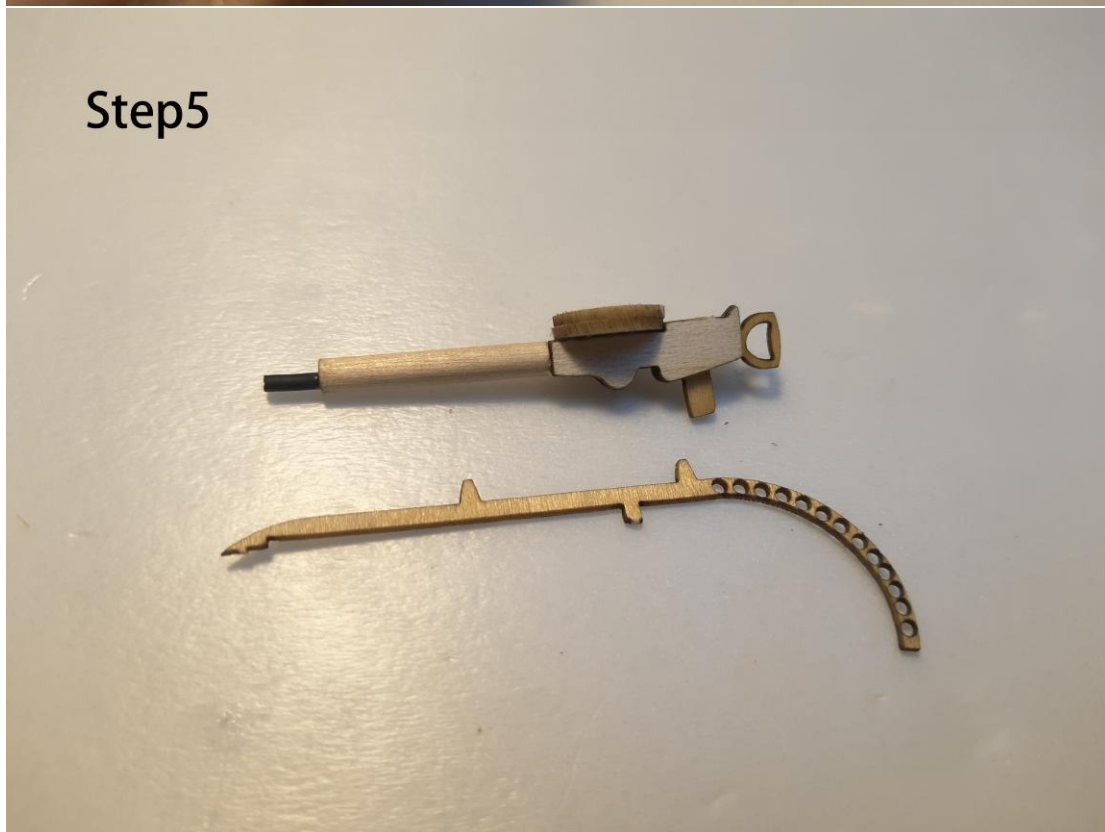

Step6



Step7

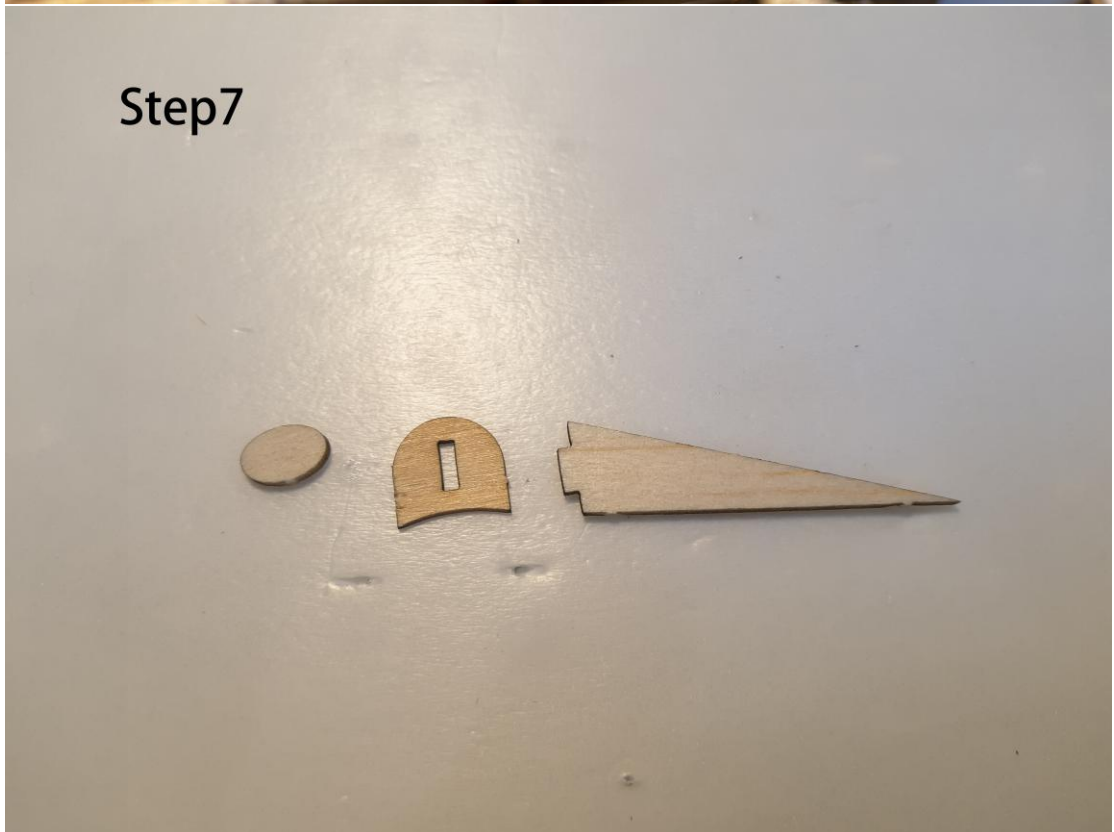

Step8



Step9

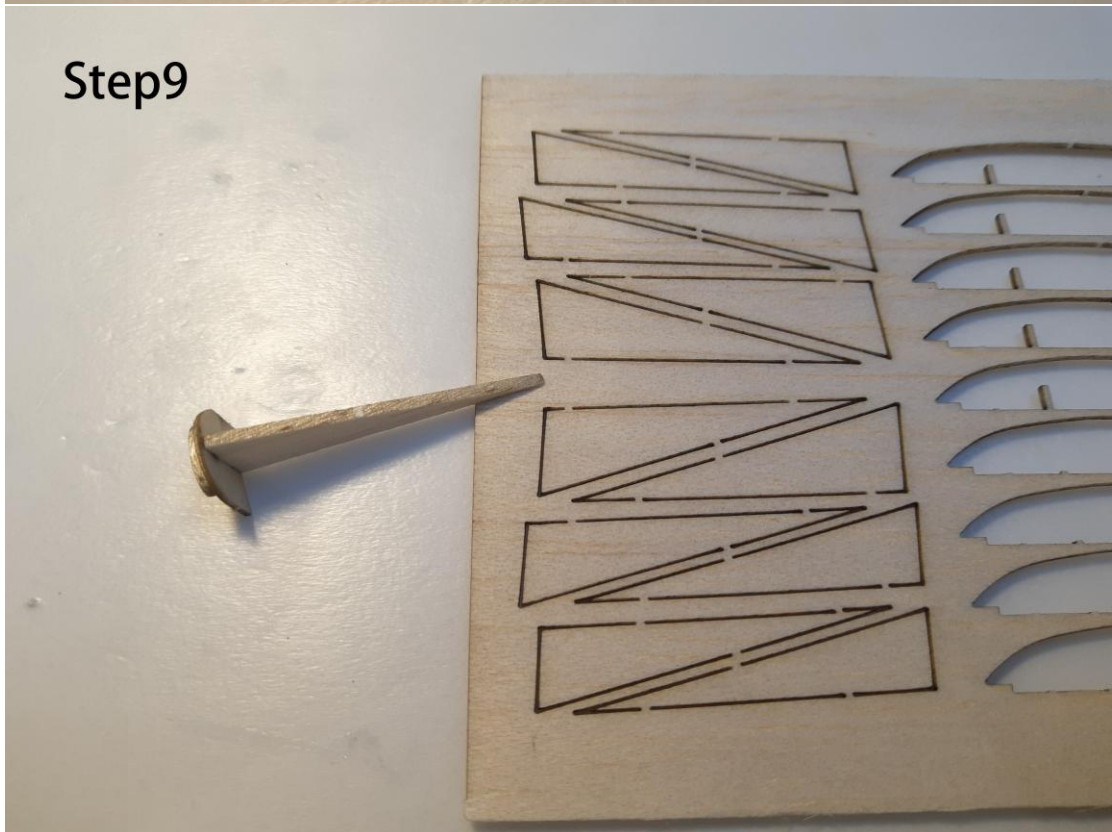

Step10



Step11



Step12



Step13



Step14



Step15



Step16



Step17



Step18

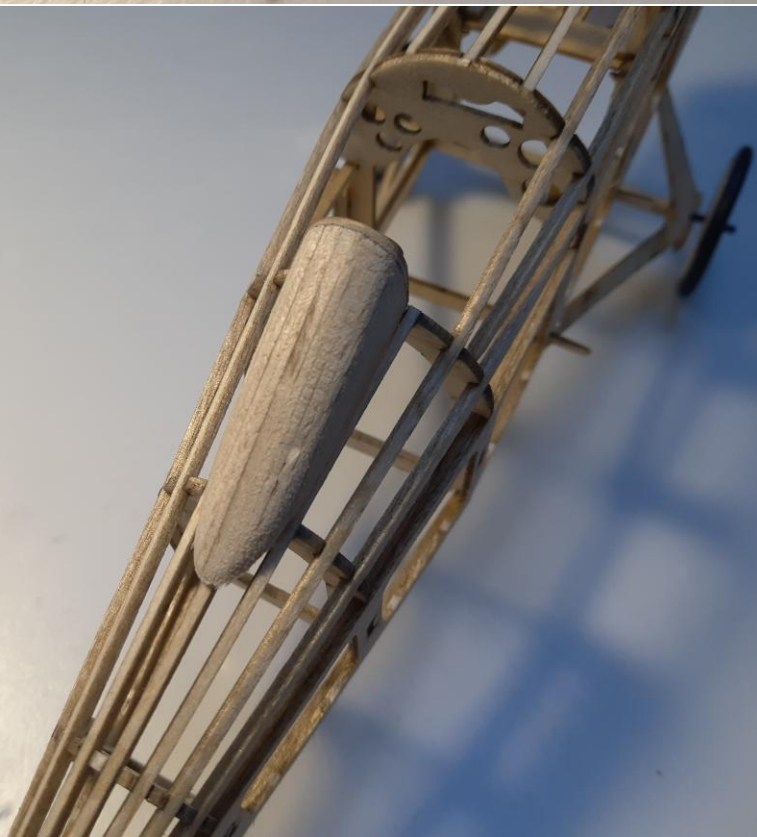

Step19

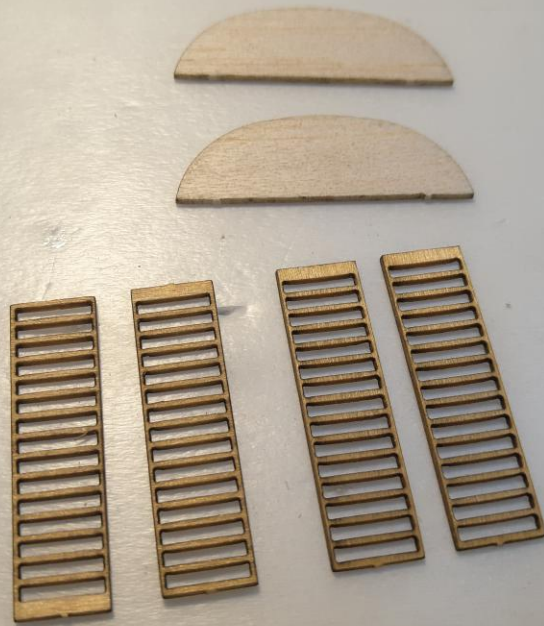

Step20

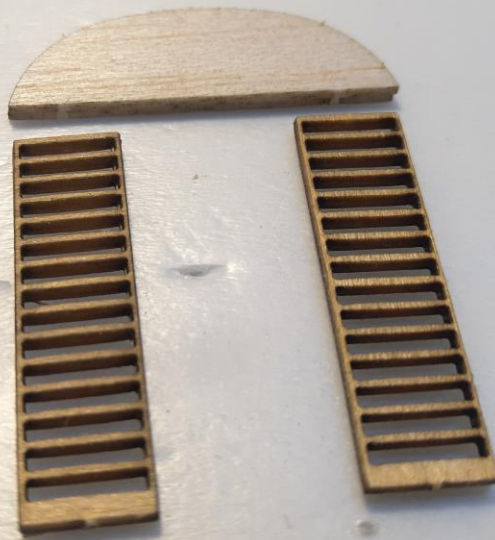

Step21



Step22

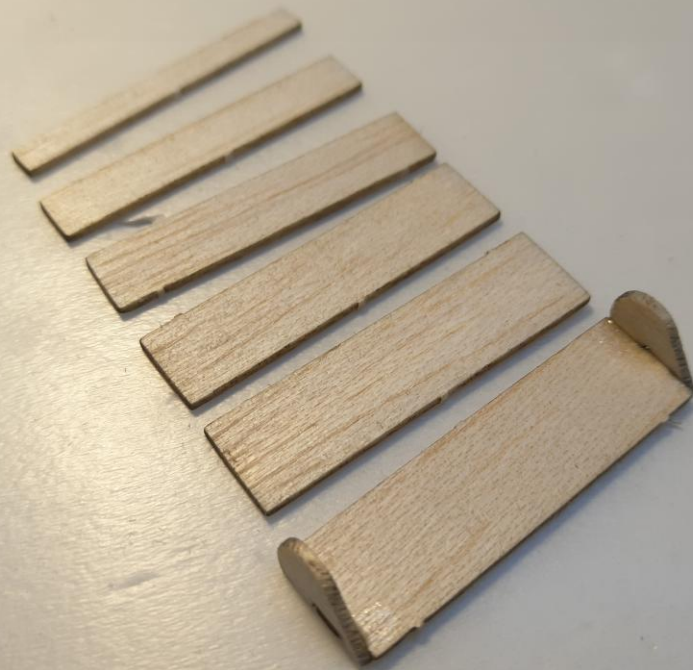

Step23



Step24



Step25



Step26



Step27

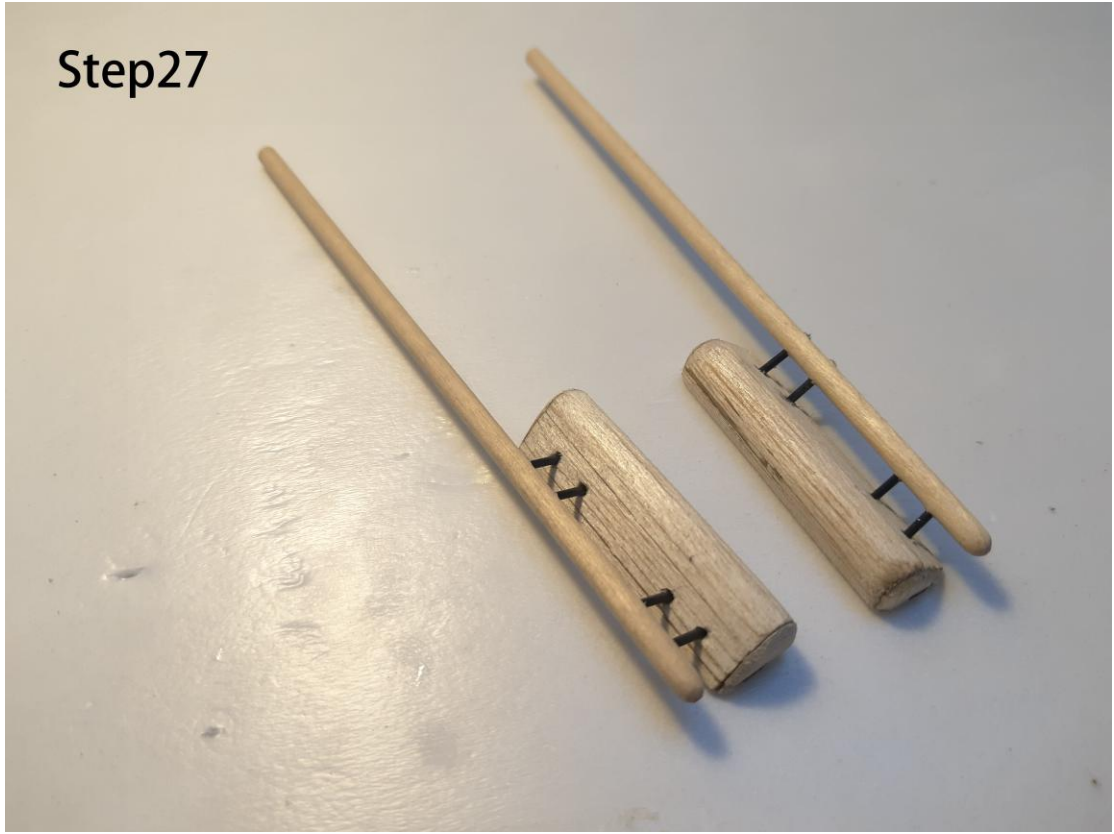

Step28

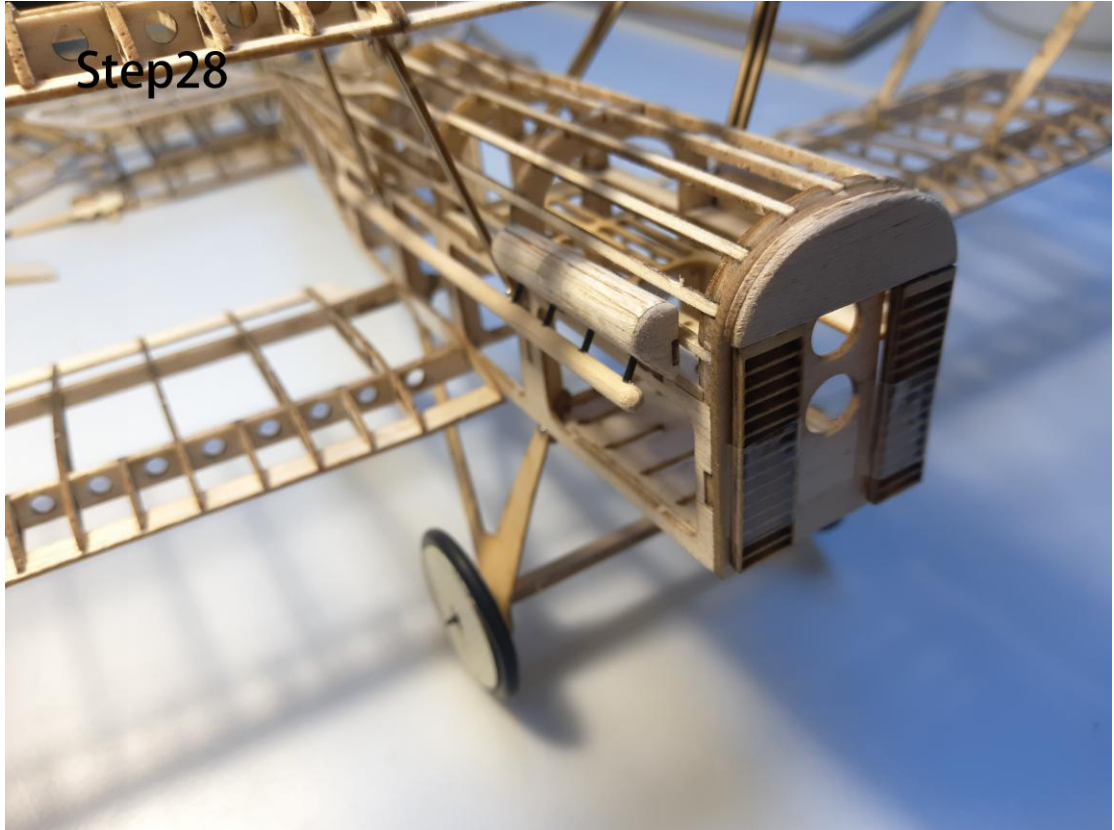

Part4. Electronics



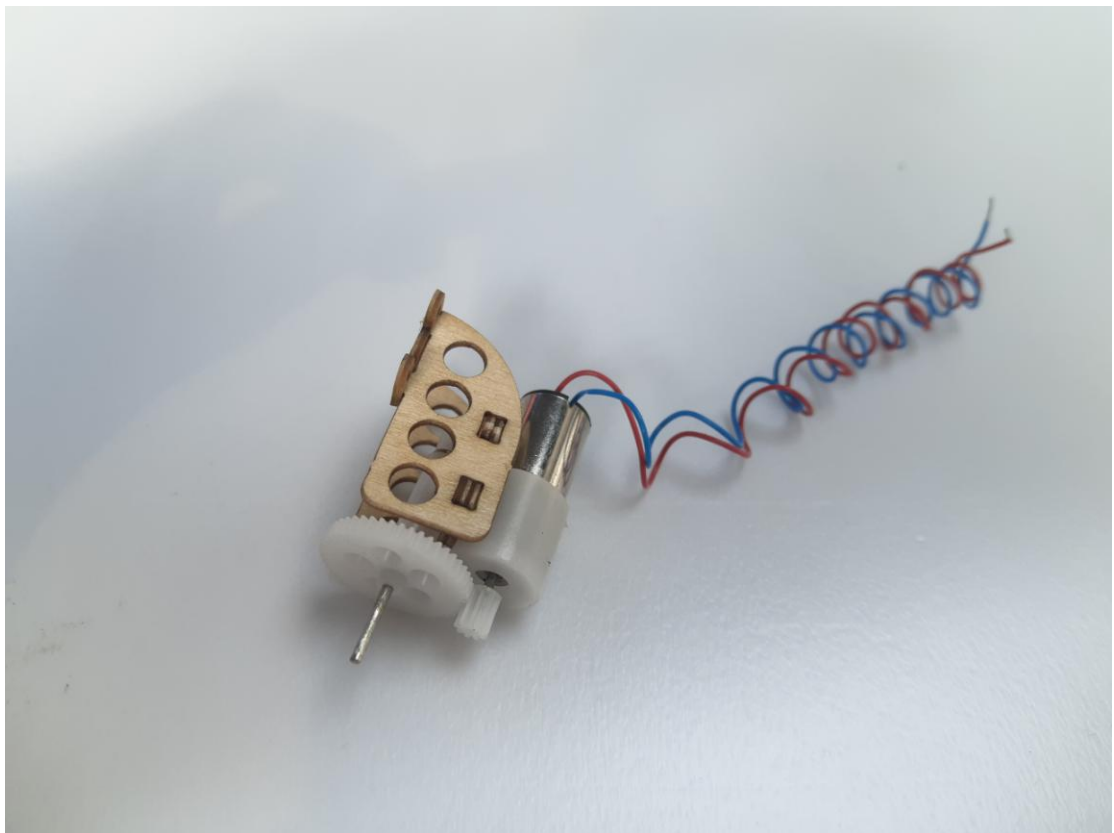

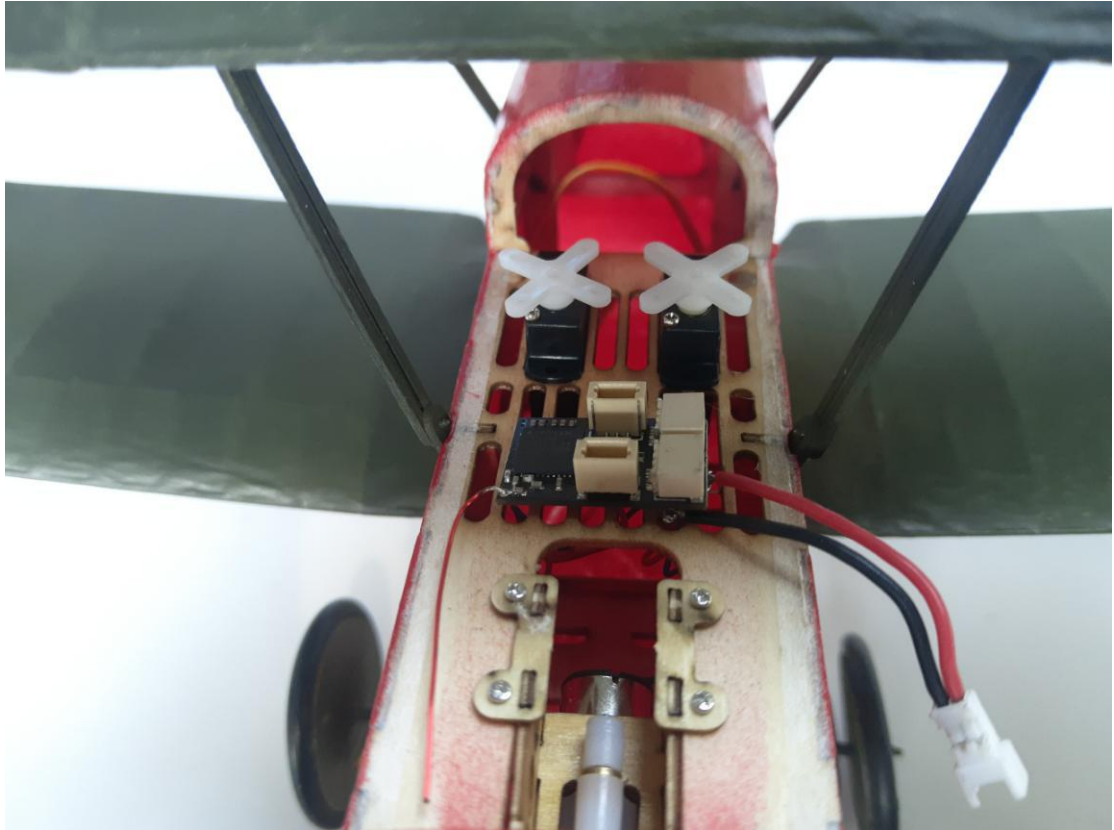
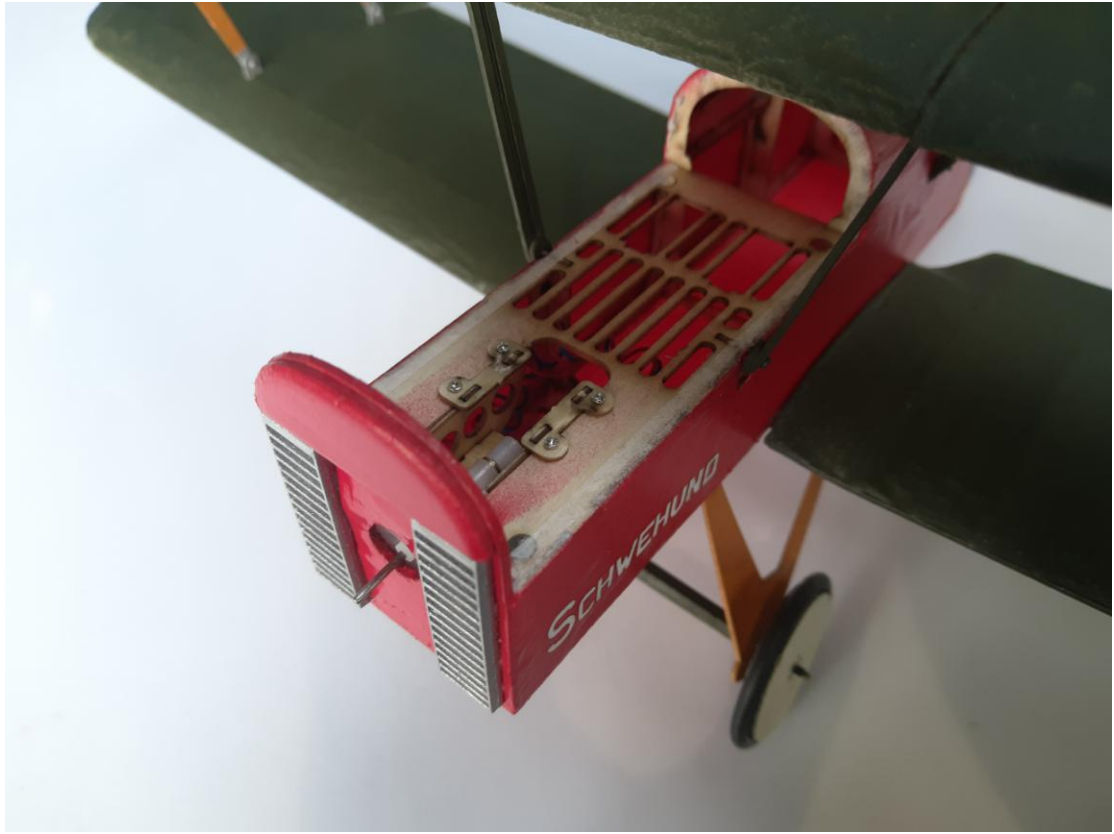



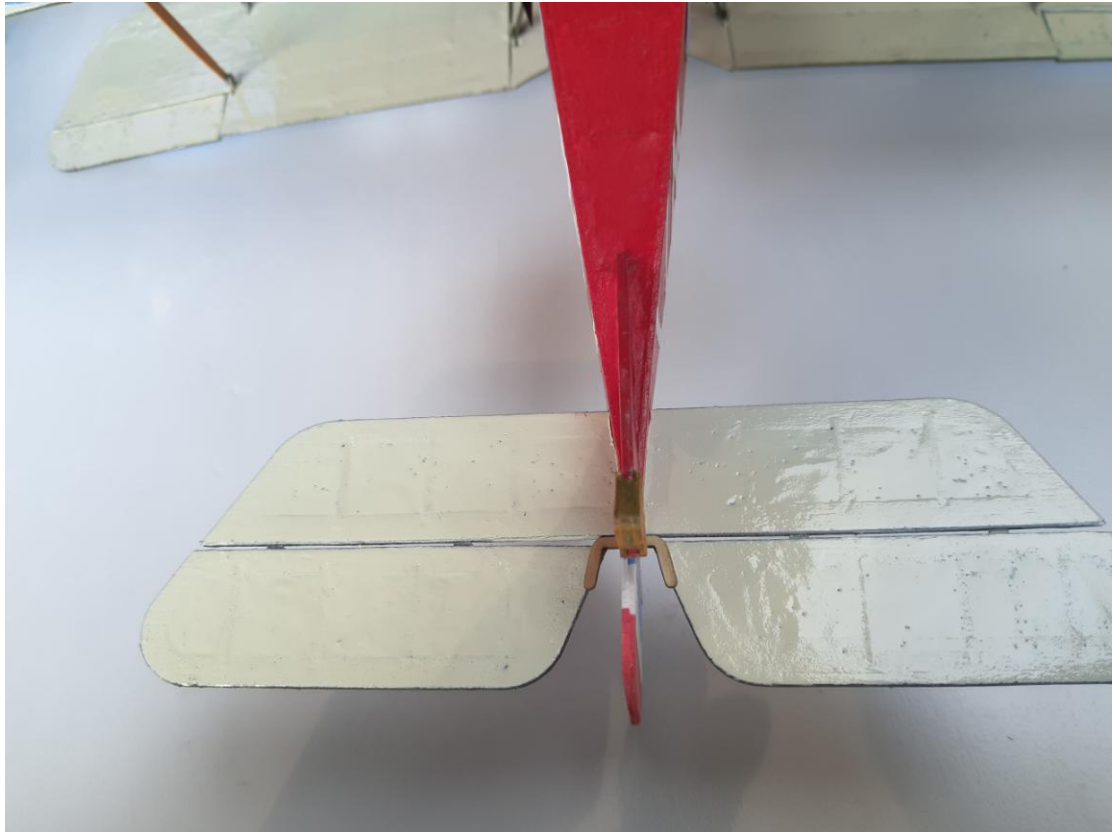

This plane designed for both 3ch and 4ch flying. If you prefer to 4ch flying, please add a 1.7g liner servo for the aileron.

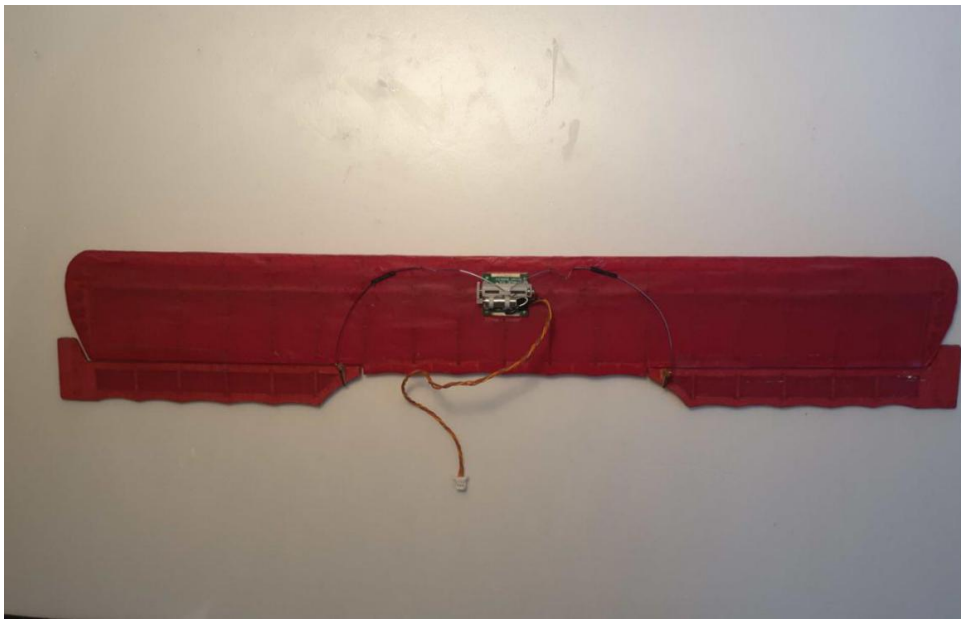

(Same way with the Fokker dr.1)

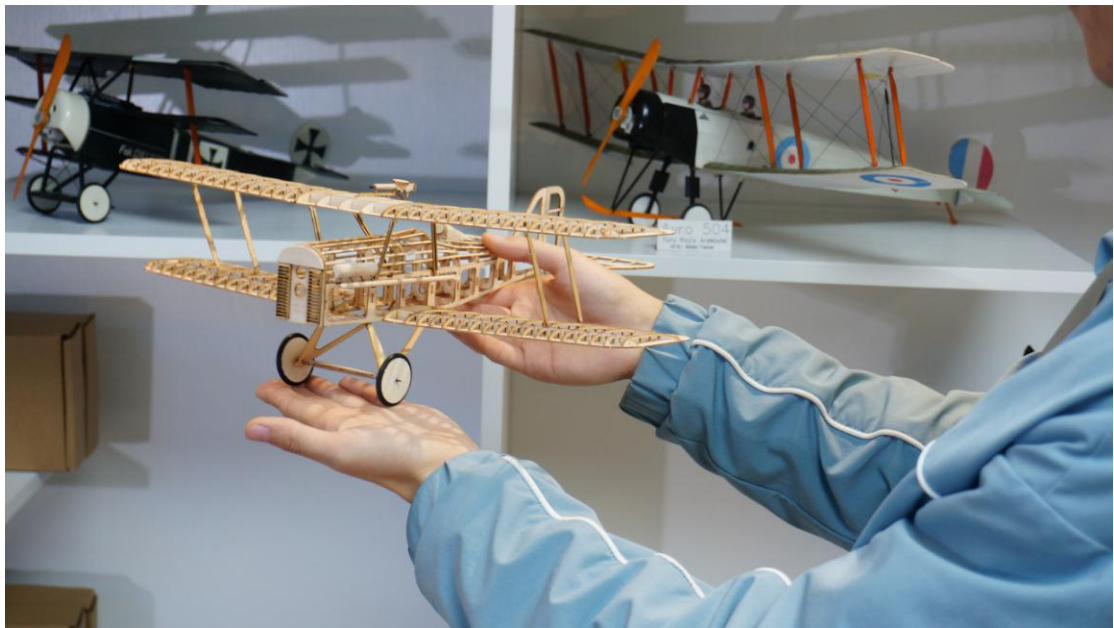
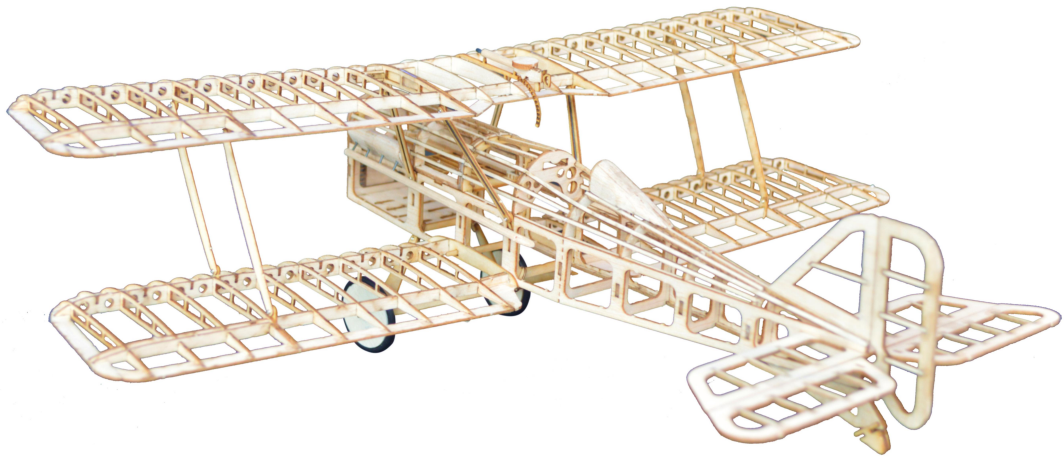

Thank you for your purchase.



Tony Ray's AeroModel

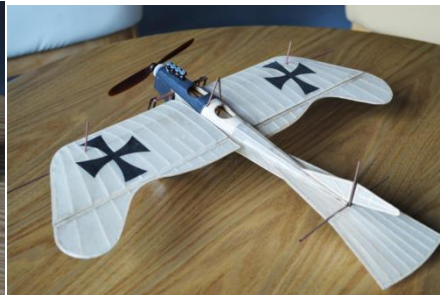

Micro scale series of TonyRay Aero Model Co.,Ltd

If you have any trouble or feedback, Please contact us

mailbox : 2721100643@qq.com