

Fokker Dr.1 Manual

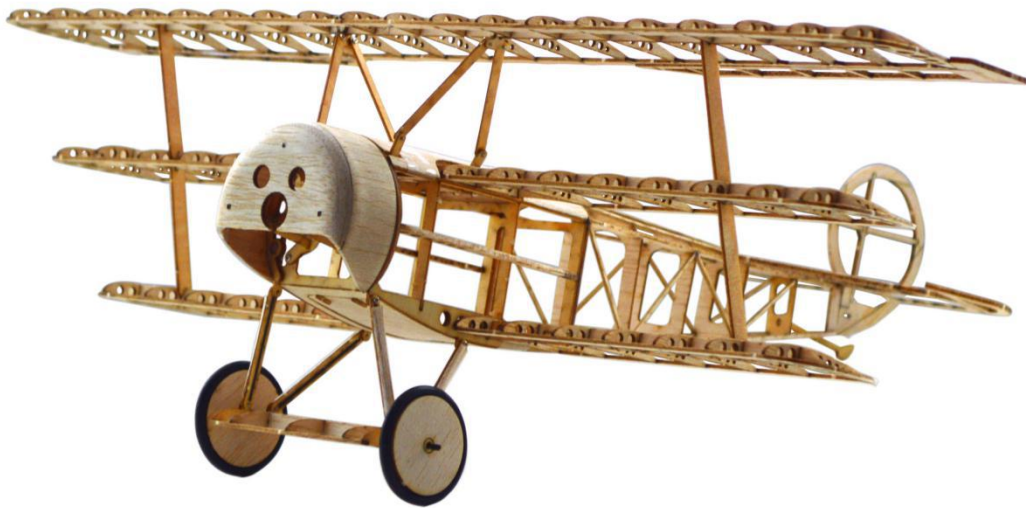

Tony Ray's AeroModel



Fokker Dr.1 - Kit Inventory

- Wood Part: Balsa wood Sheets *4, Basswood Sheets *1
- Hardware Part: Carbon rod * 2, Micro Hinge * 1, Micro screw * 20, Rubber wheel * 2, Heat shrink tube*1, Mini Magnet*8
- Paper Part: Installation drawings *3, Covering tissue * 1

Required Electronics

- RC Transmitter with at least 4 channels
 - Receiver/1.7g Micro servo
 - Motor 8.5mm coreless motor with gearbox
 - Propeller,5.5in or 138mm prop /LiPo battery
-
- Please read the manual completely before building the model.
 - When the main parts are completed (such as the wing, tail, and fuselage), please do not bond them directly . It is recommended to cover them with the tissue first, and then combine them.

Part1: Framework

Step 1



Step 2



Step 3



Step 4



Step 5



Step 6



Step 7



Step 8



Step 9



Step 10



Step 11



Step 12



Step 13



Step 14

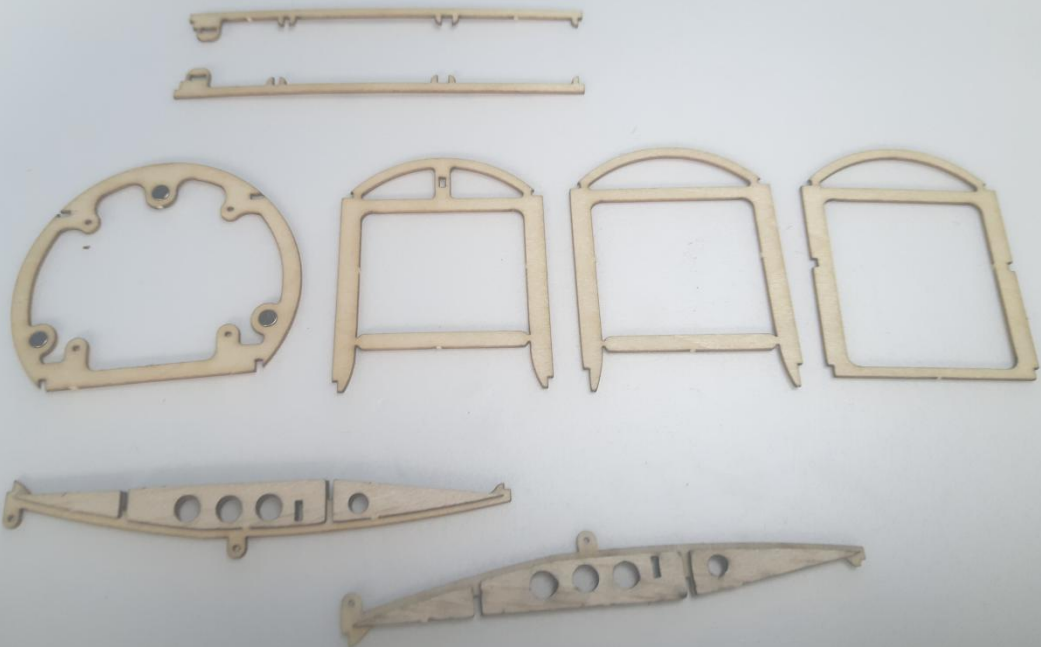

Step 15

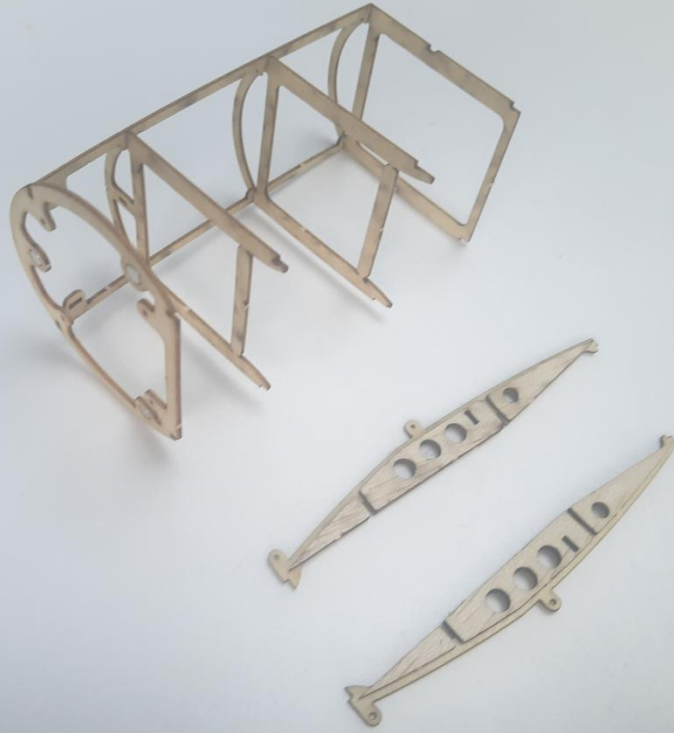

Step 16

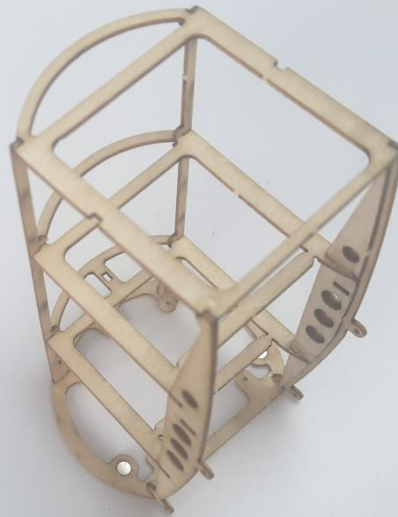

Step 17

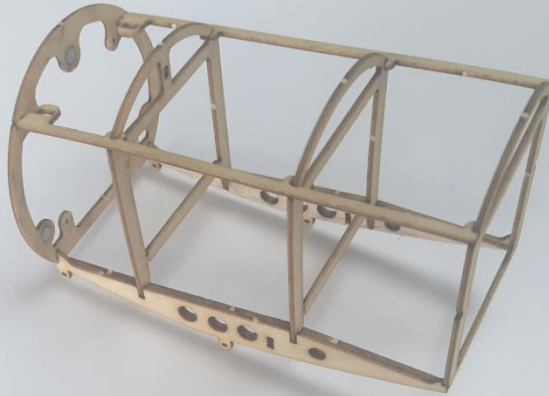

Step 18

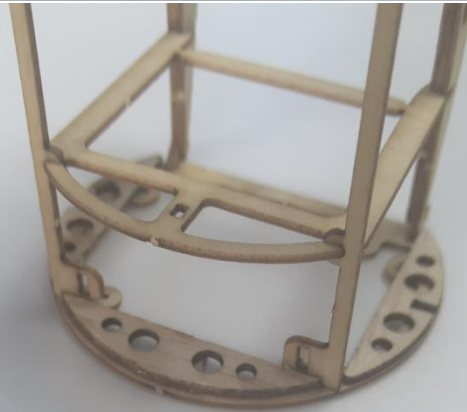

Step 19

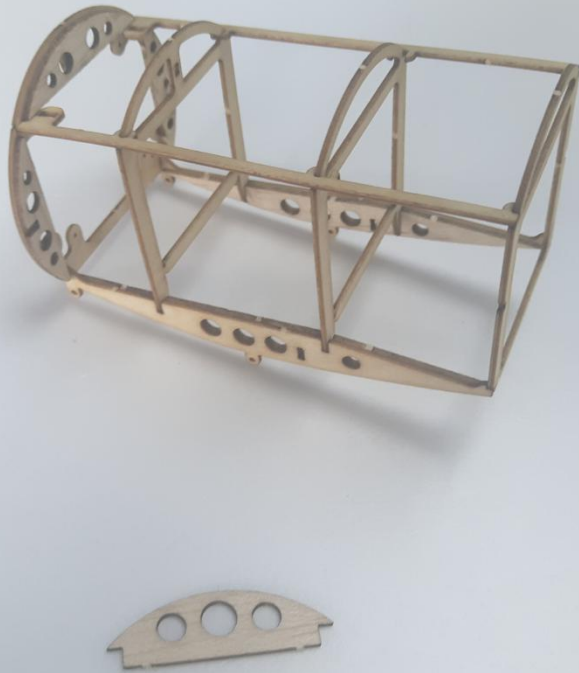

Step 20

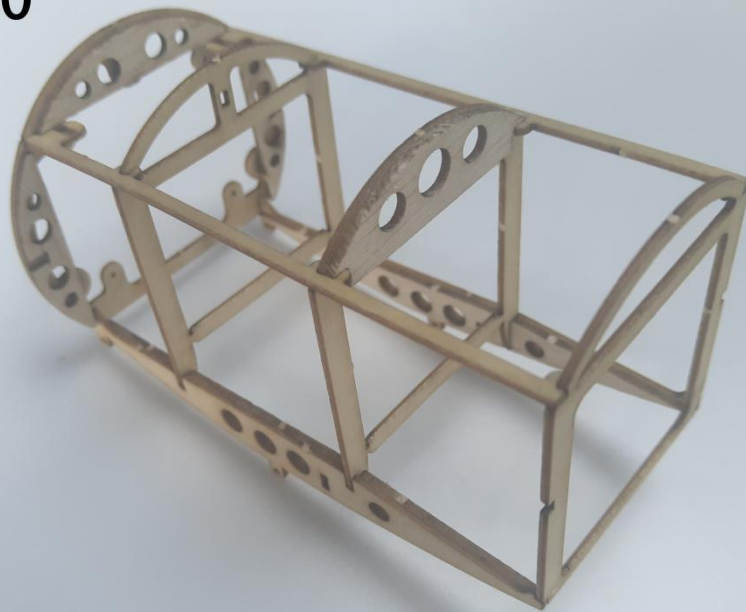

Step 21

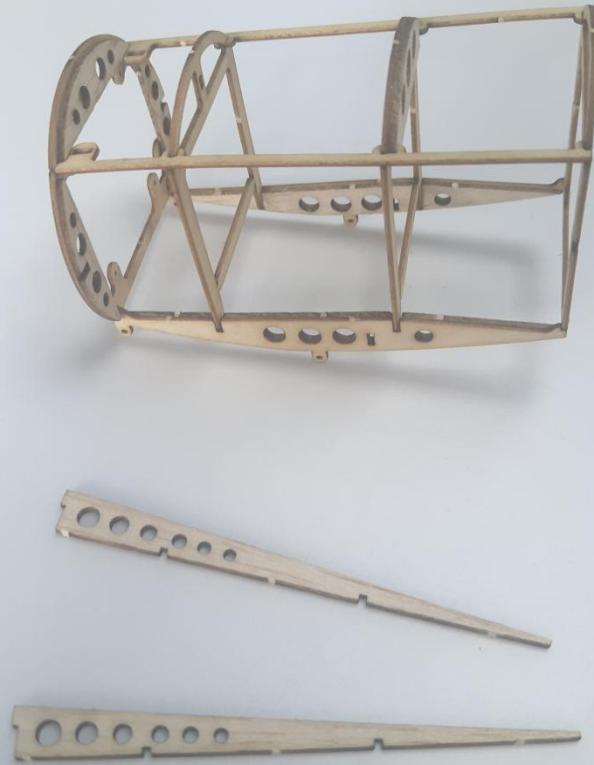

Step 22

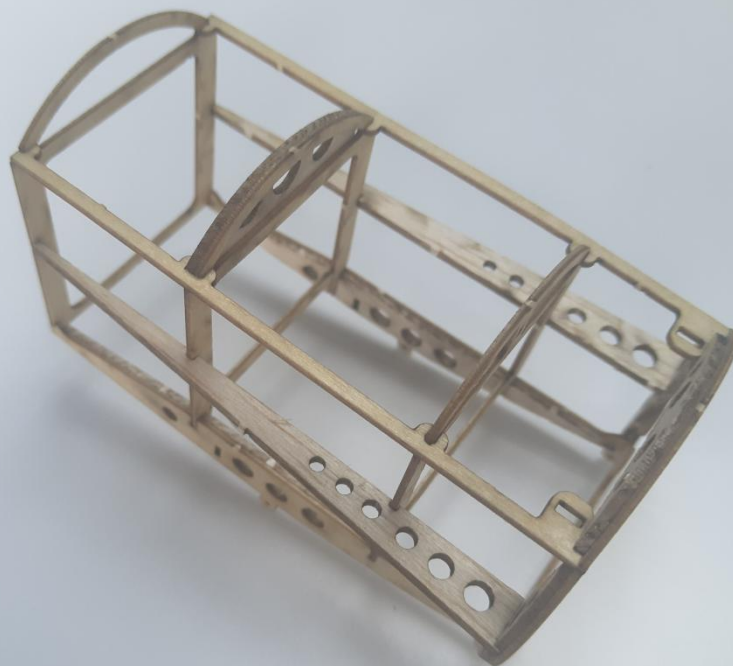

Step 23



Step 24



Step 25

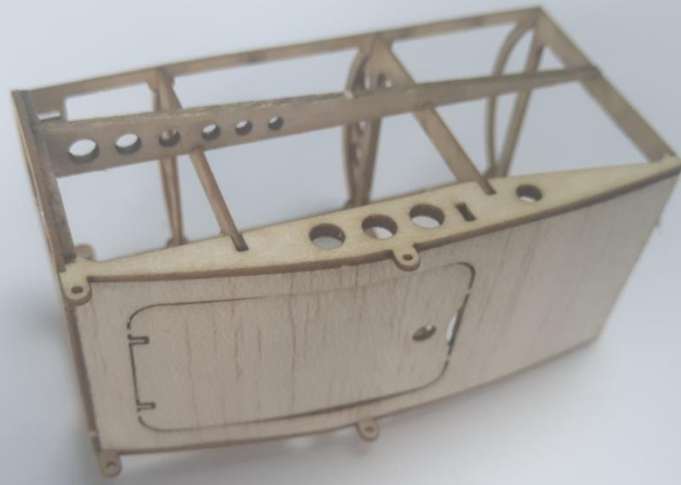

Step 26



Step 27



Step 28

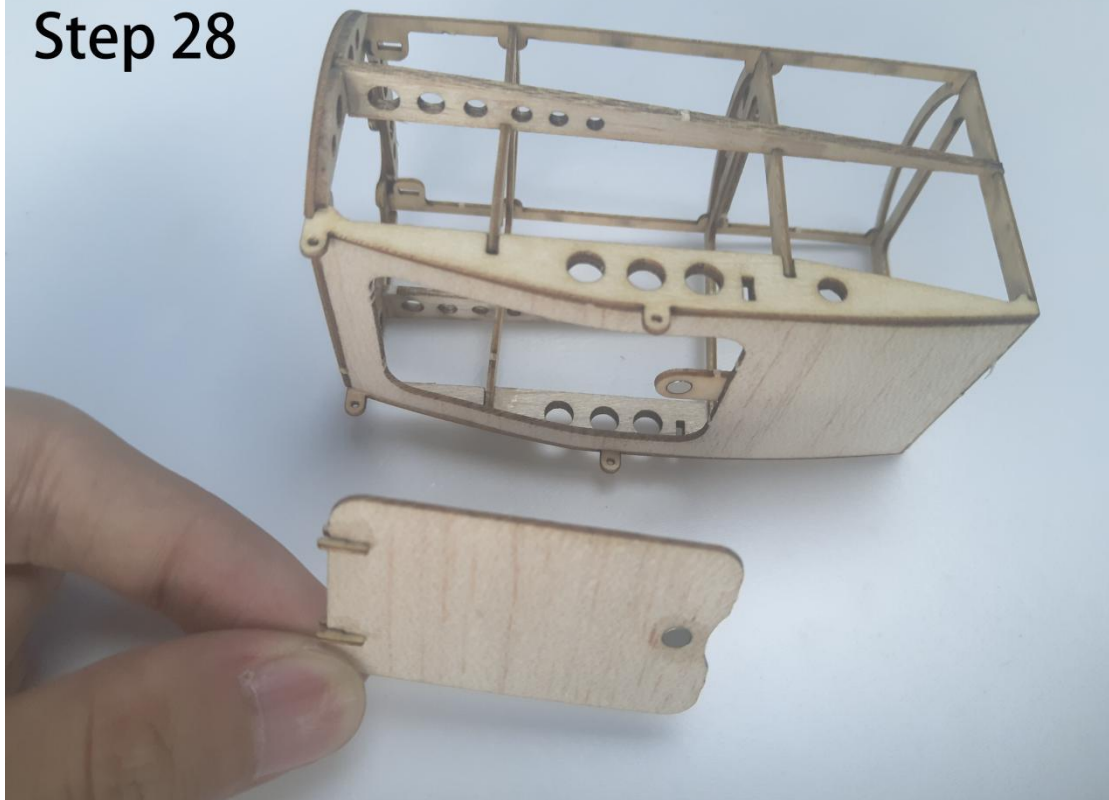

Step 29

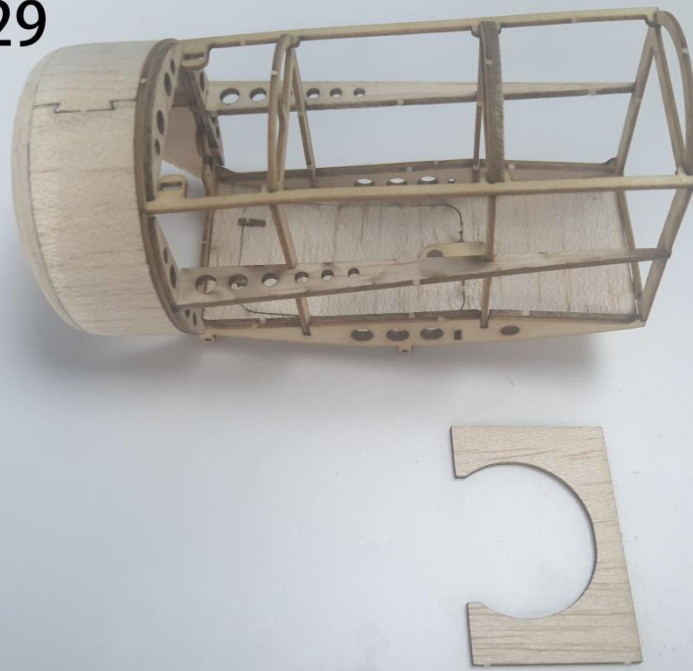

Step 30

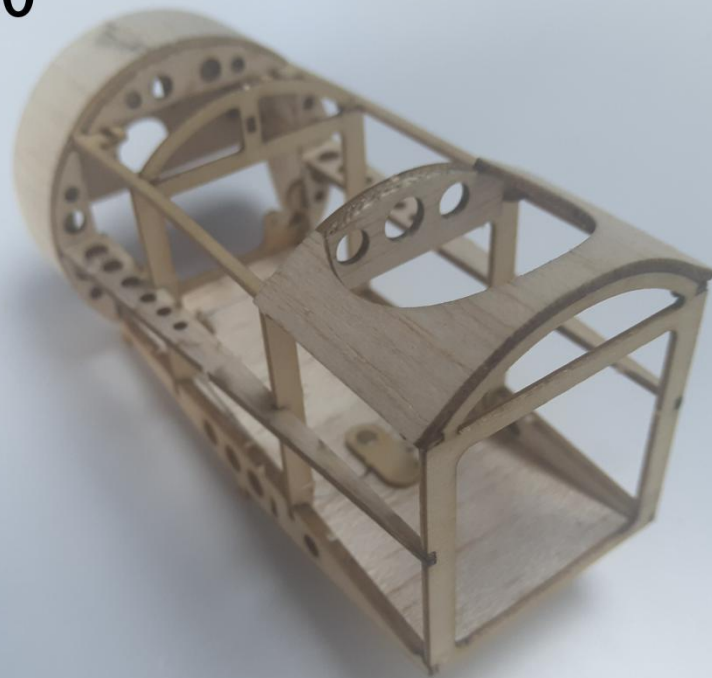

Step 32

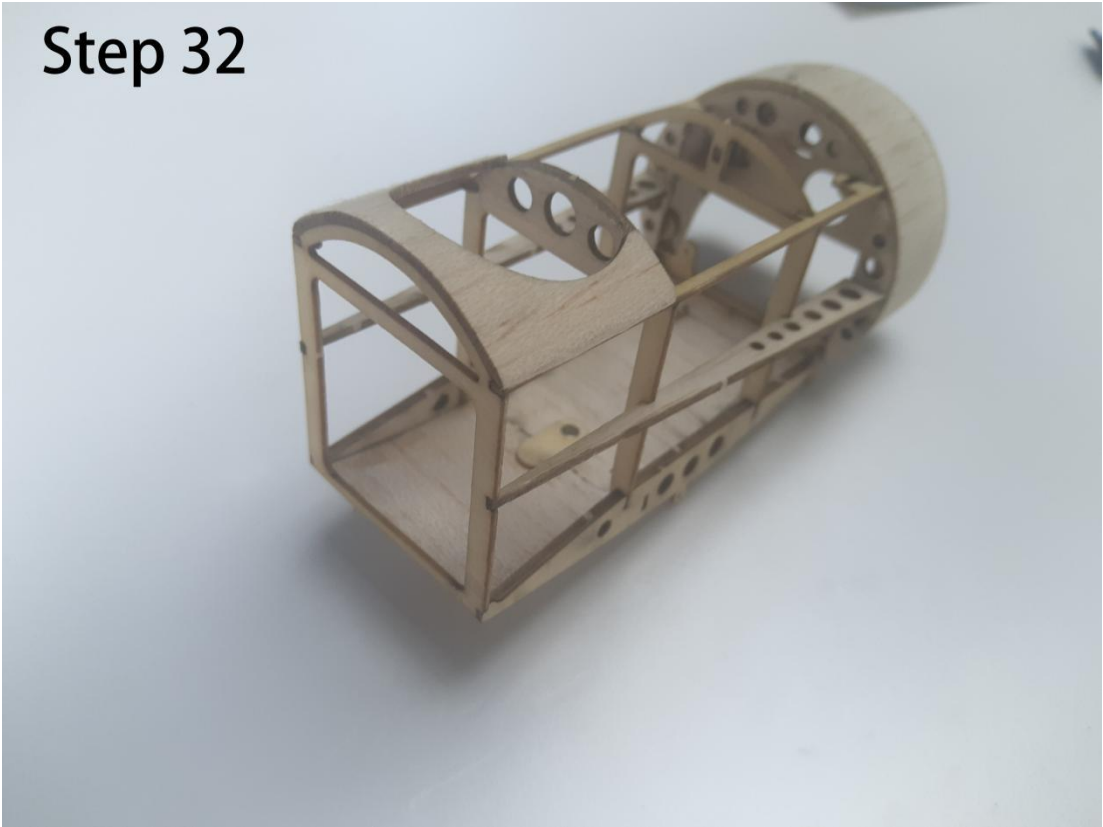

Step 32

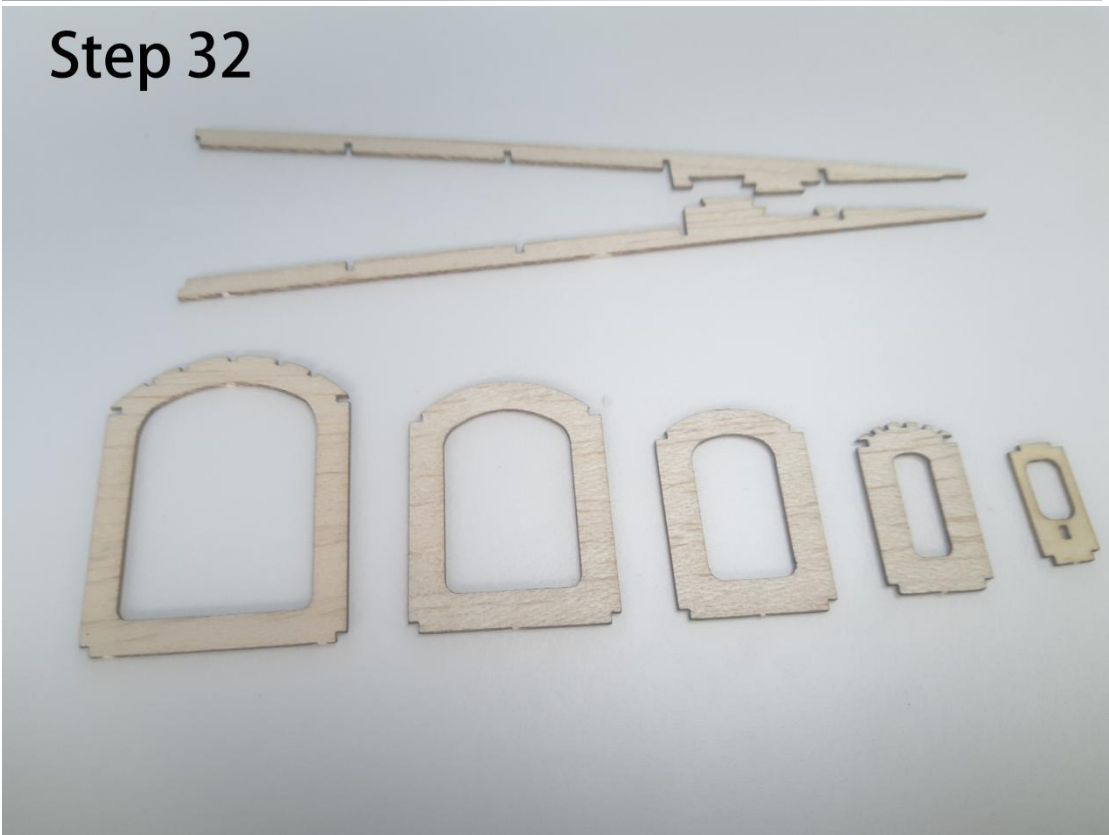

Step 33

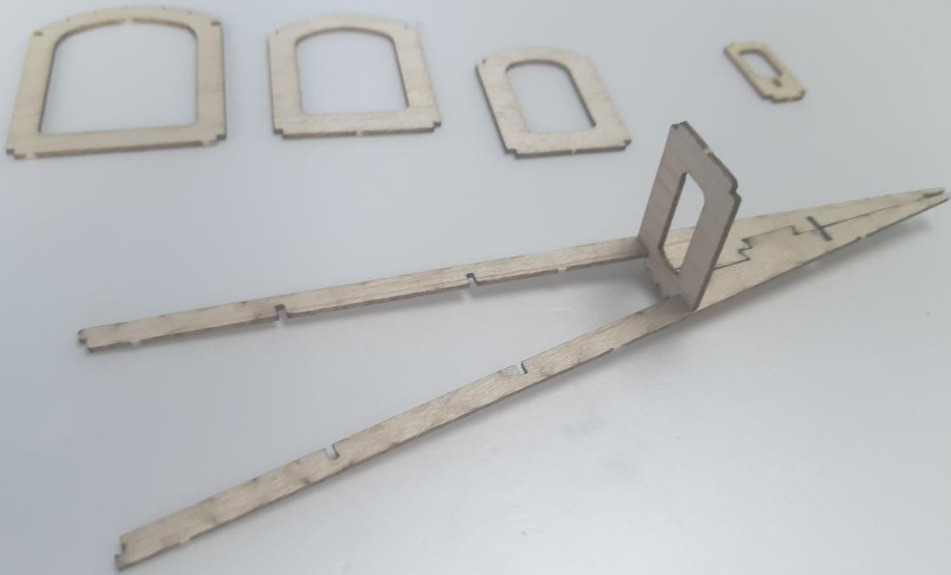

Step 34

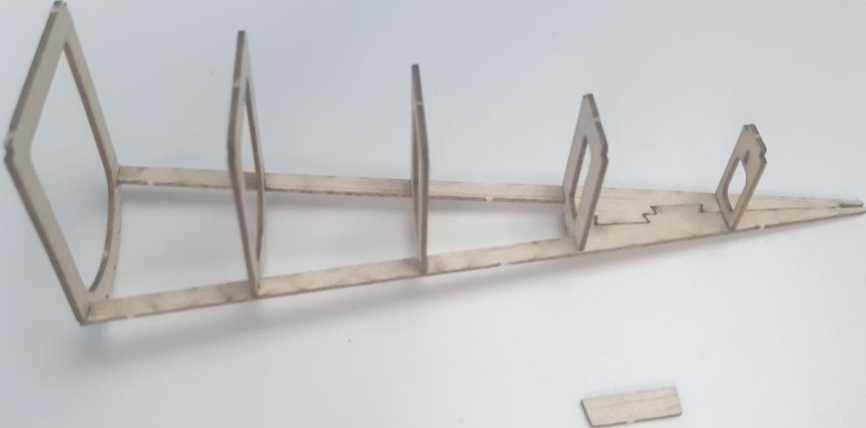

Step 35



Step 36

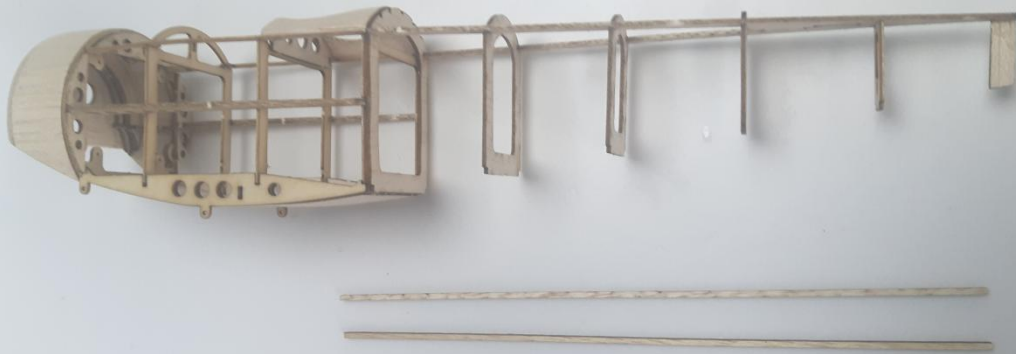

Step 37

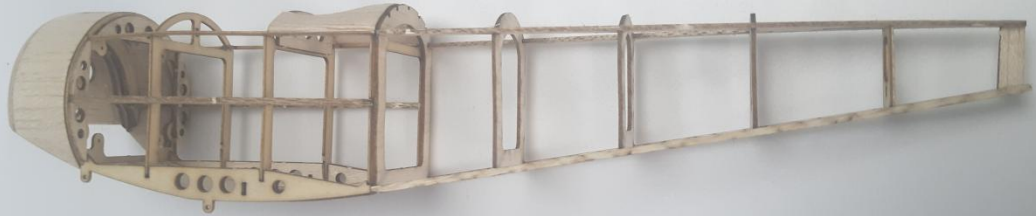

Step 38

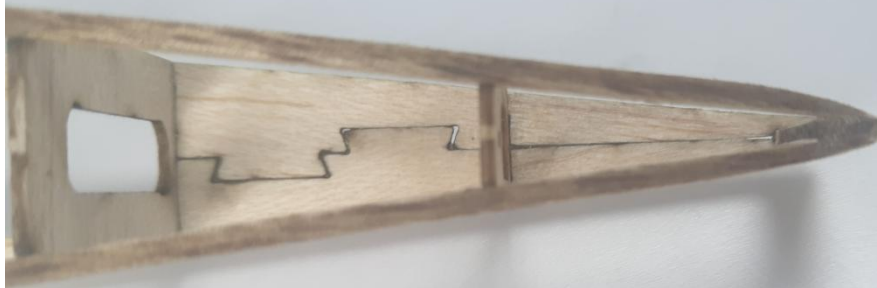

Step 39



Step 40





Step 43

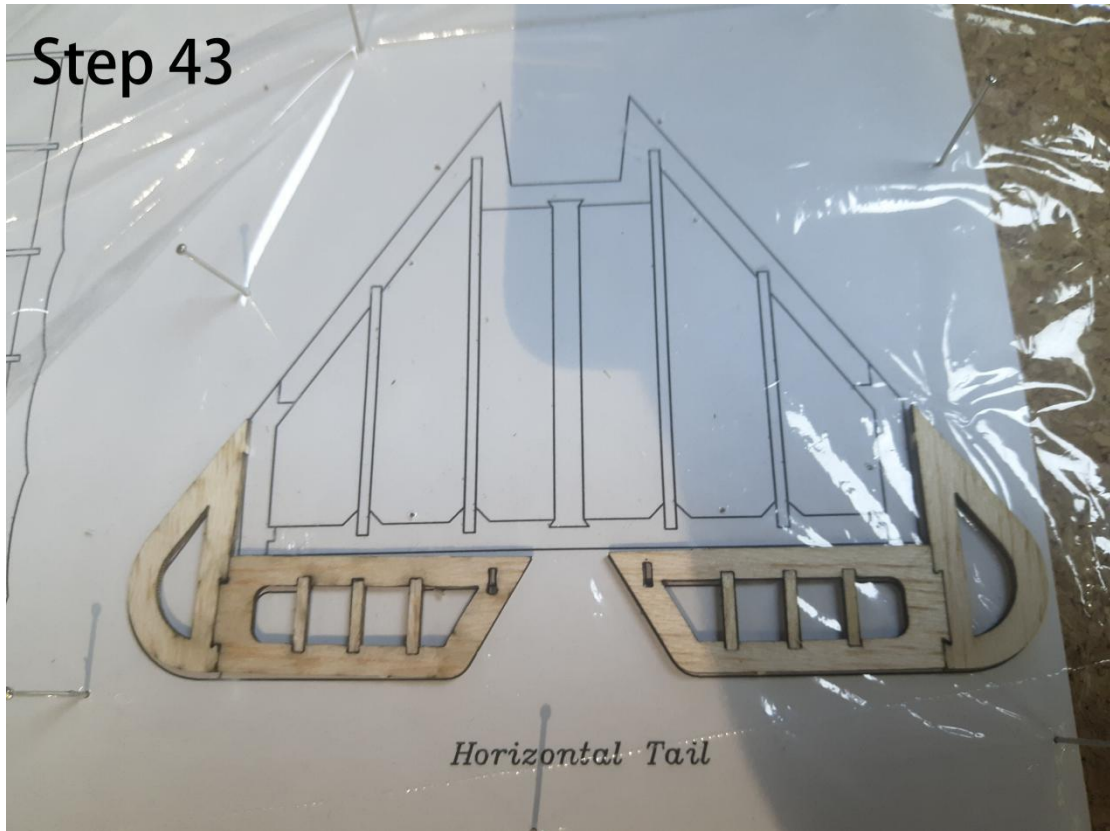

Step 44



Step 45

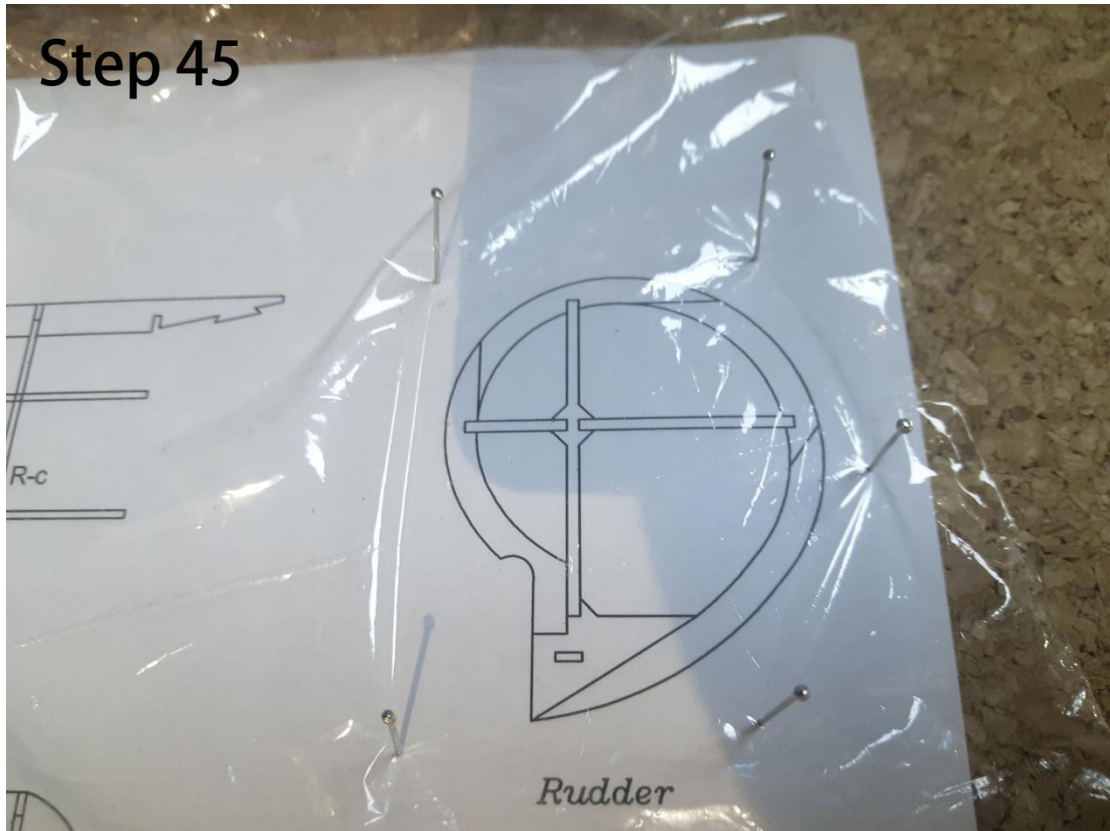

Step 46

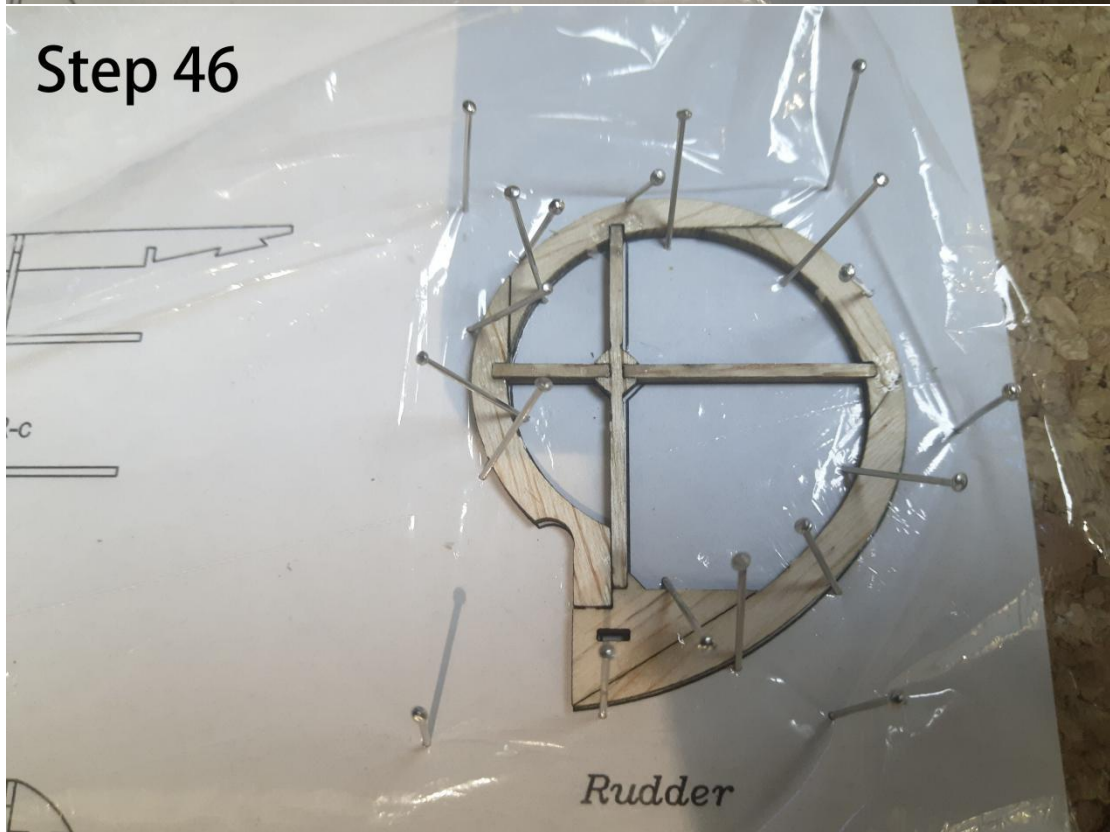

Step 47



Step 48

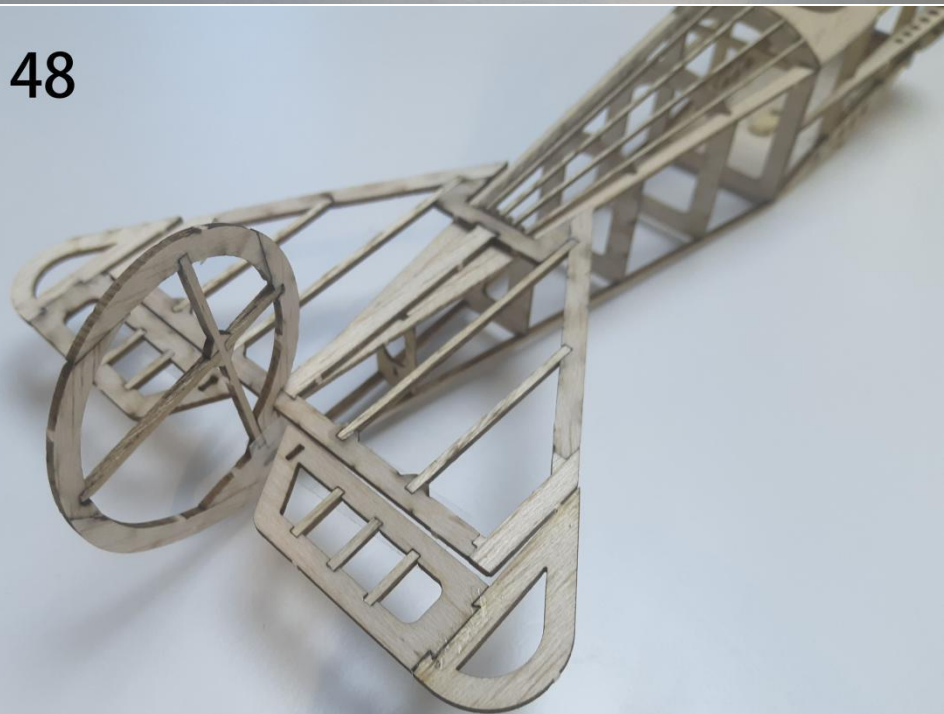

Step 49



Step 50

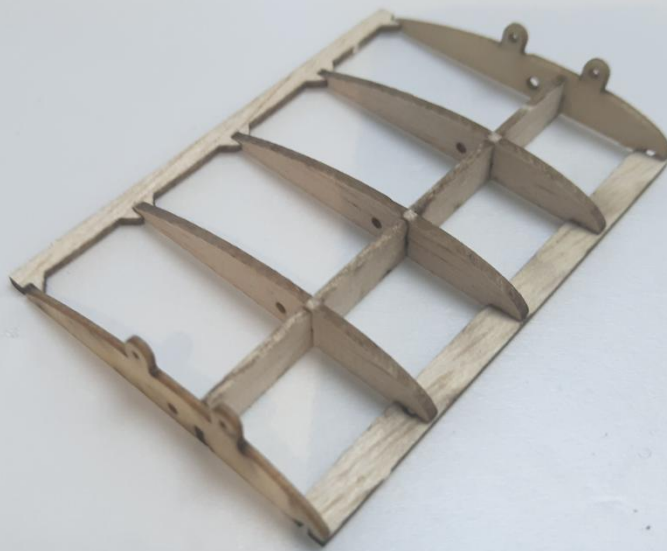

Step 51



Step 52



Step 53



Step 54

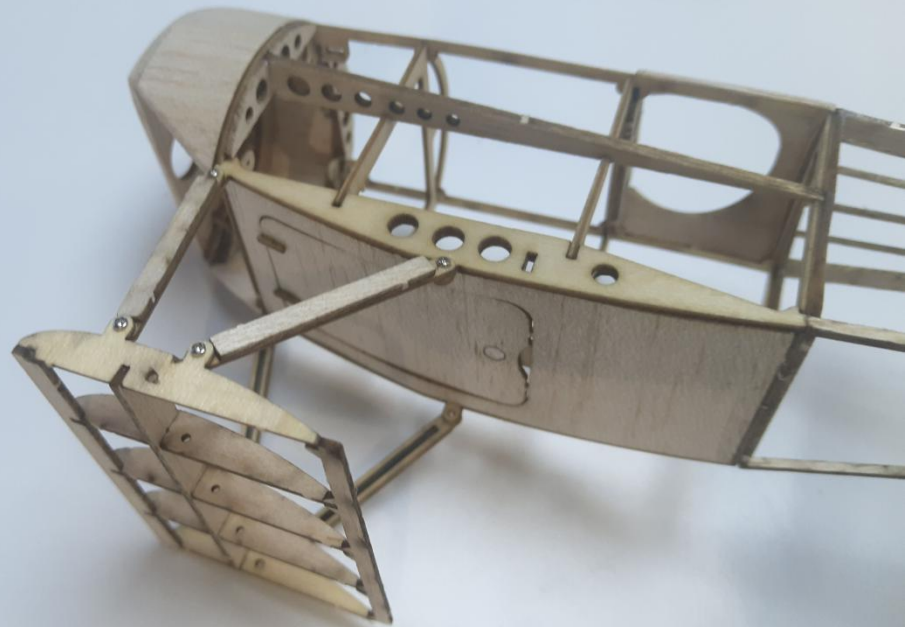

Step 55



Step 56

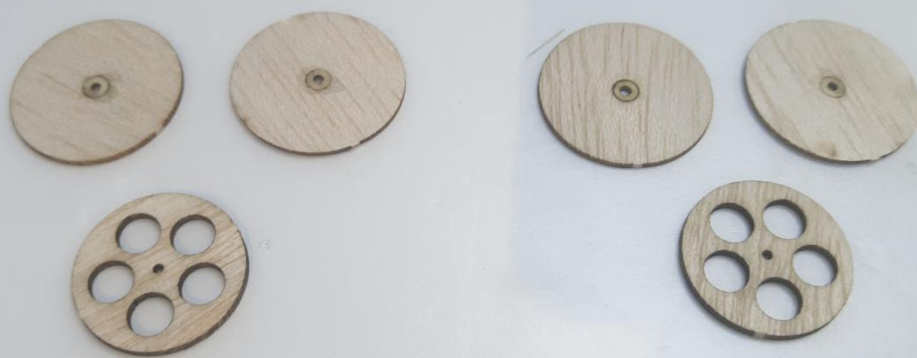

Step 57



Step 58



Step 59



Step 60

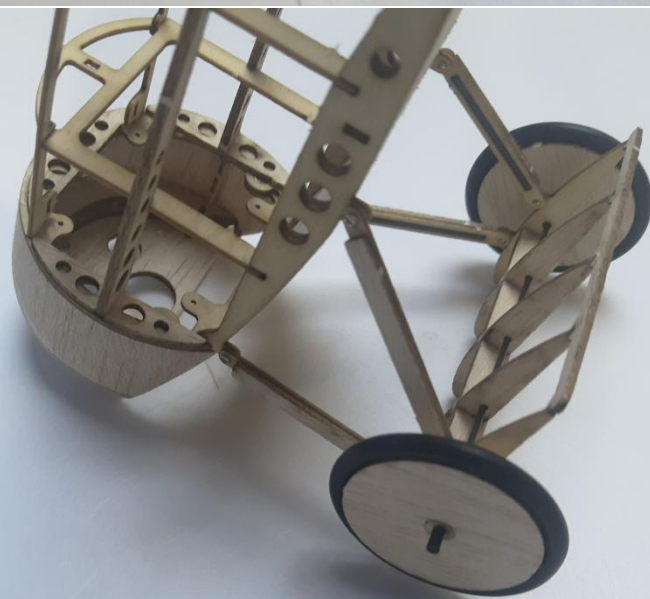

Step 61



Step 62



Step 63



Step 64



Step 65

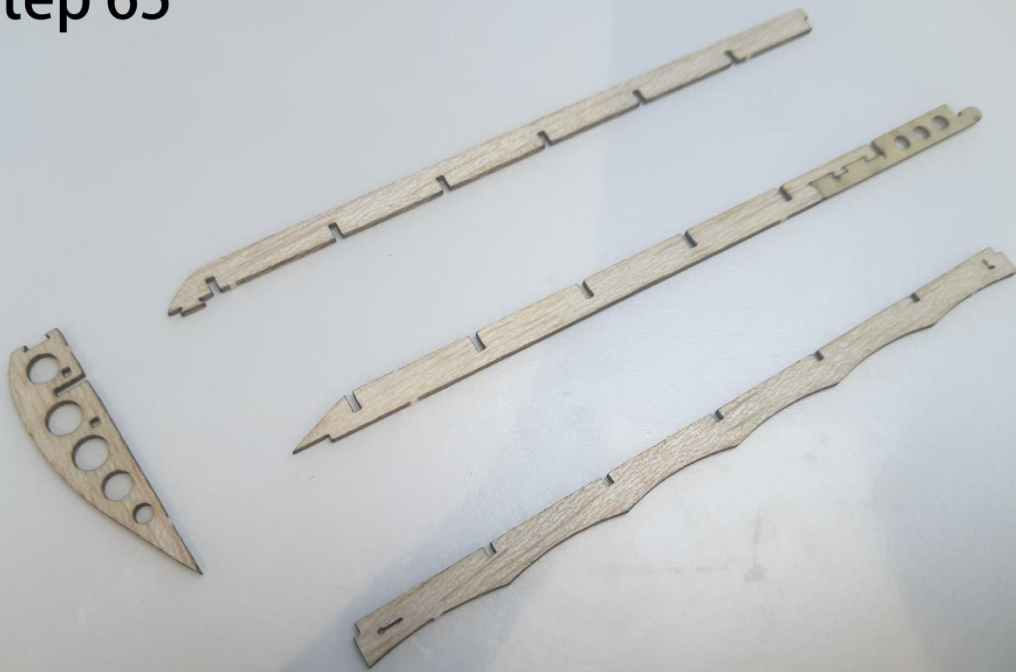

Step 66

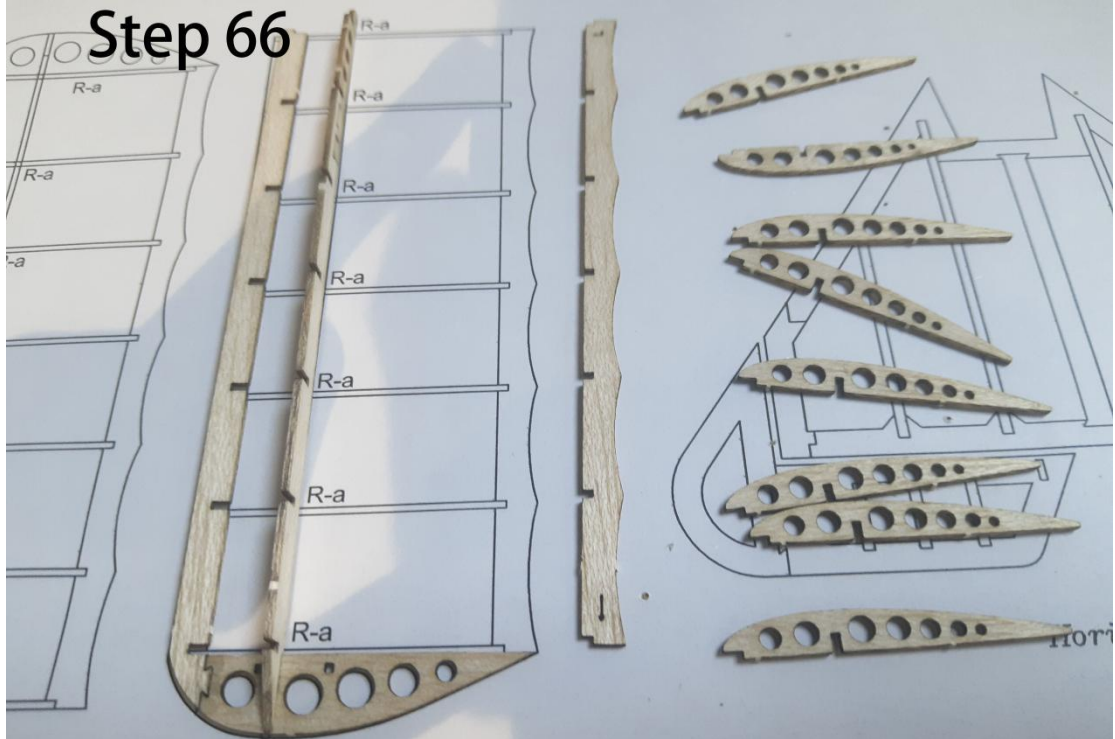

Step 67

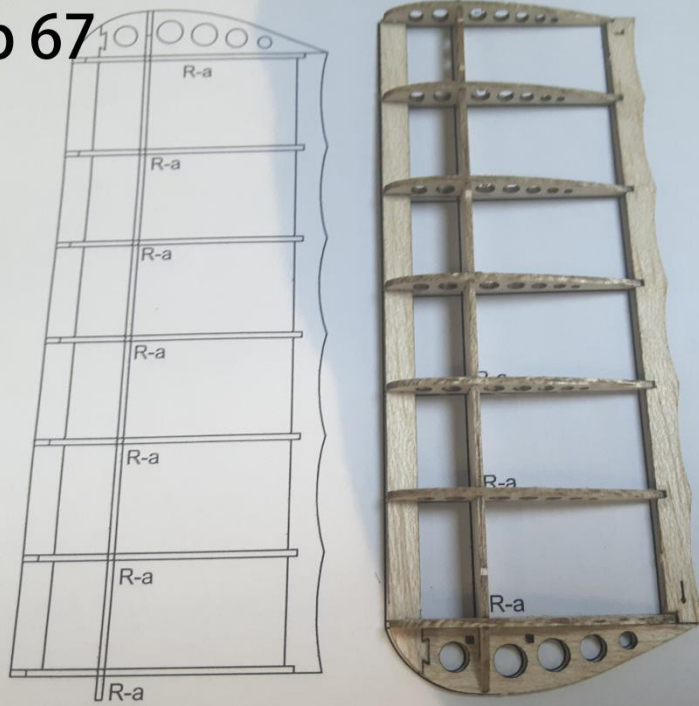

Bottom Wings

Step 68

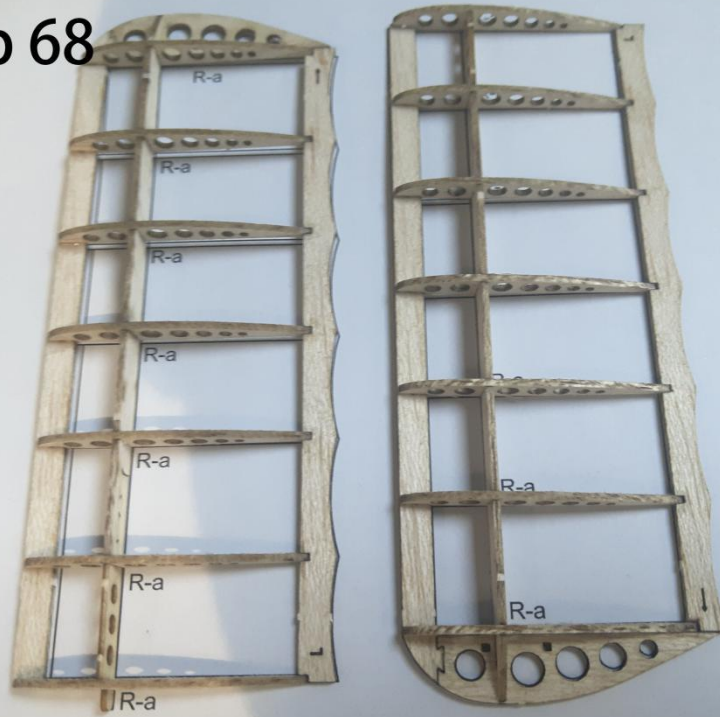

Bottom Wings

Step 69

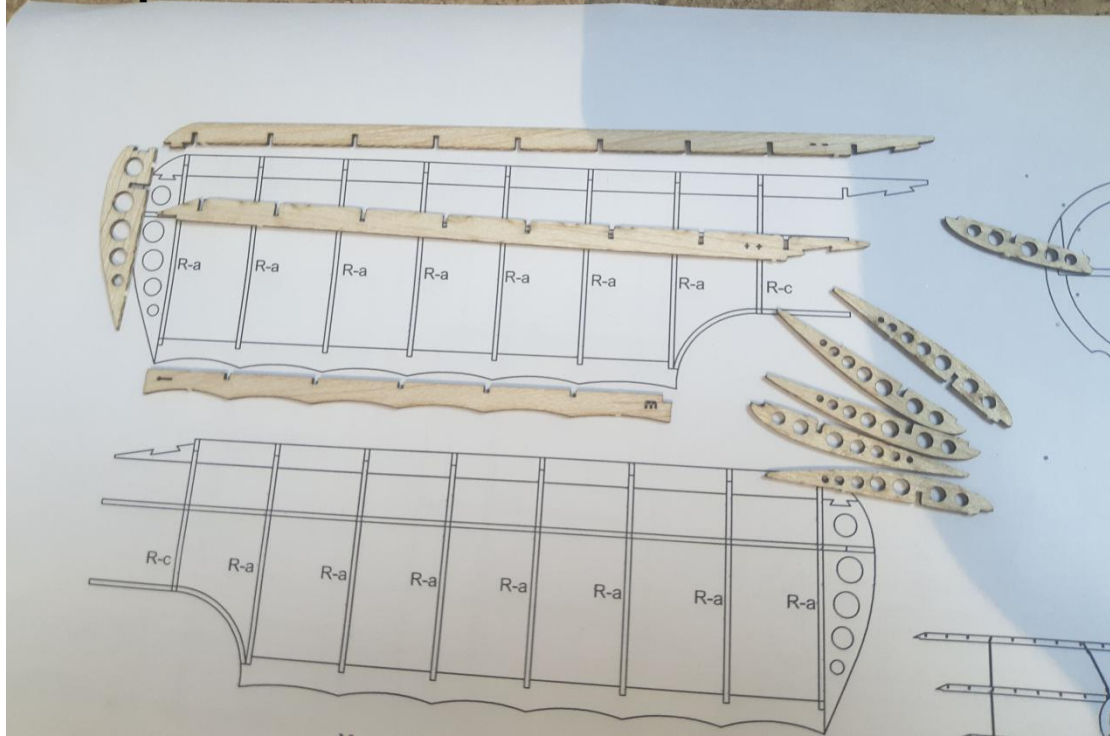

Step 70

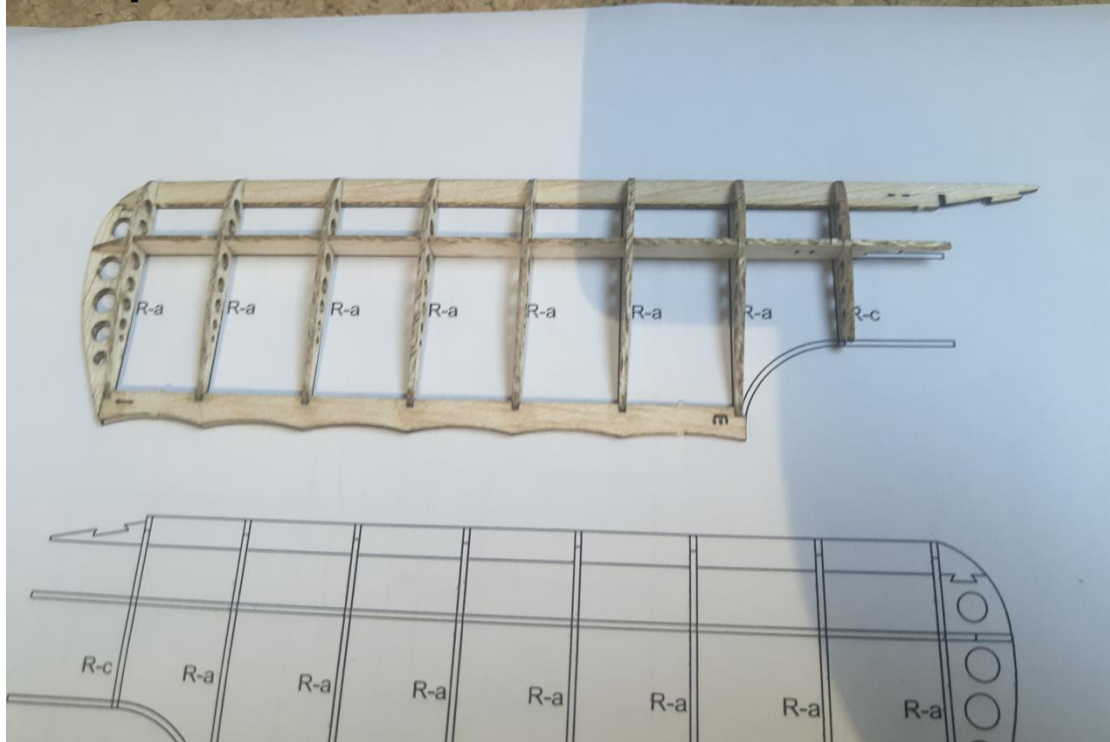

Step 71

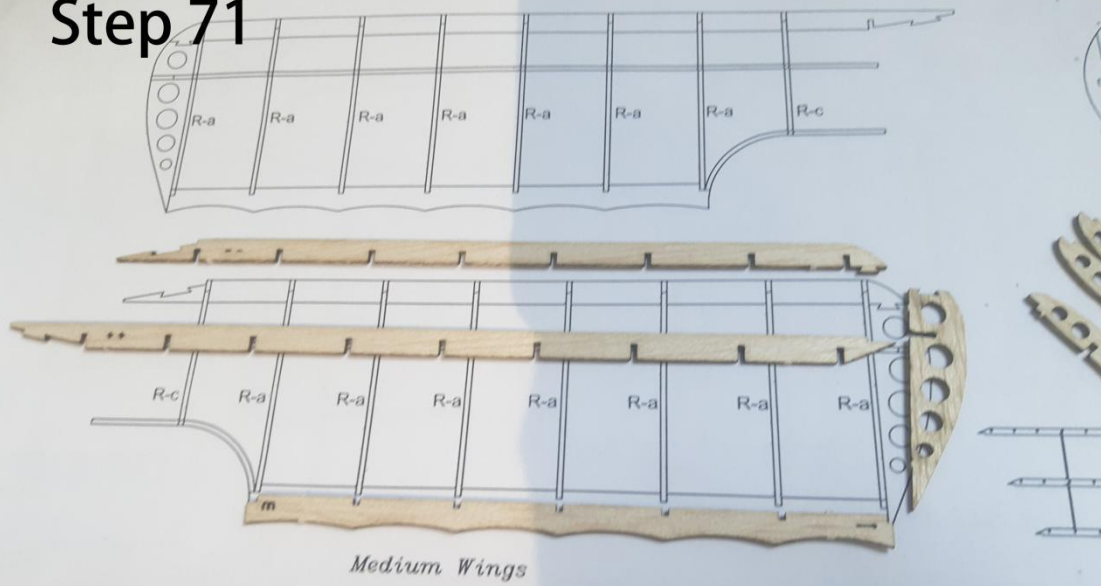

Step 72

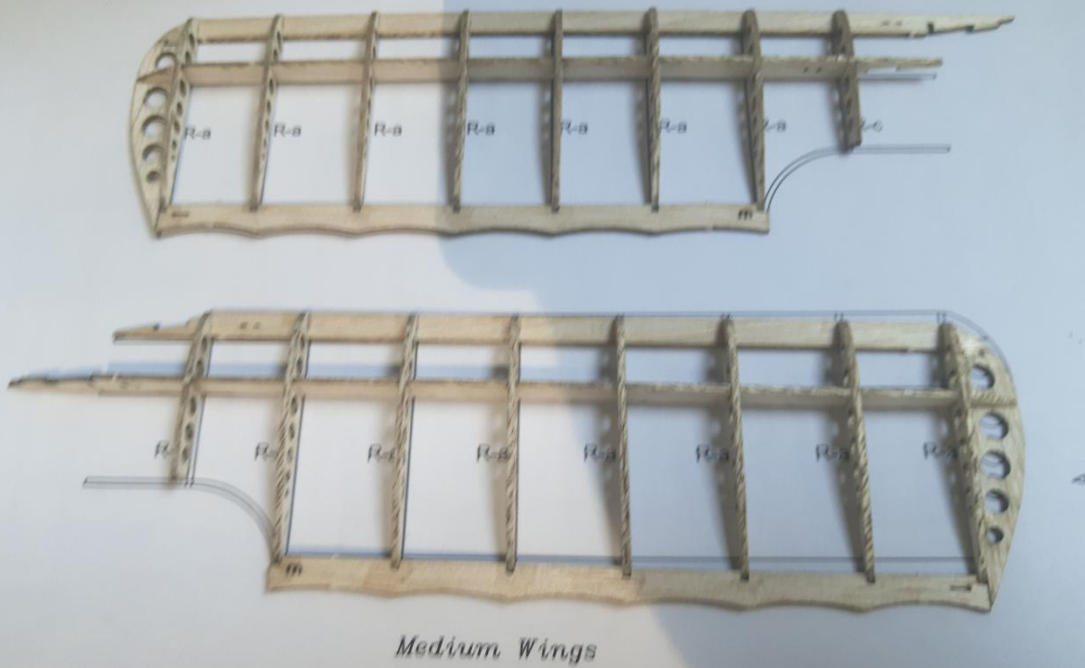

Step 73

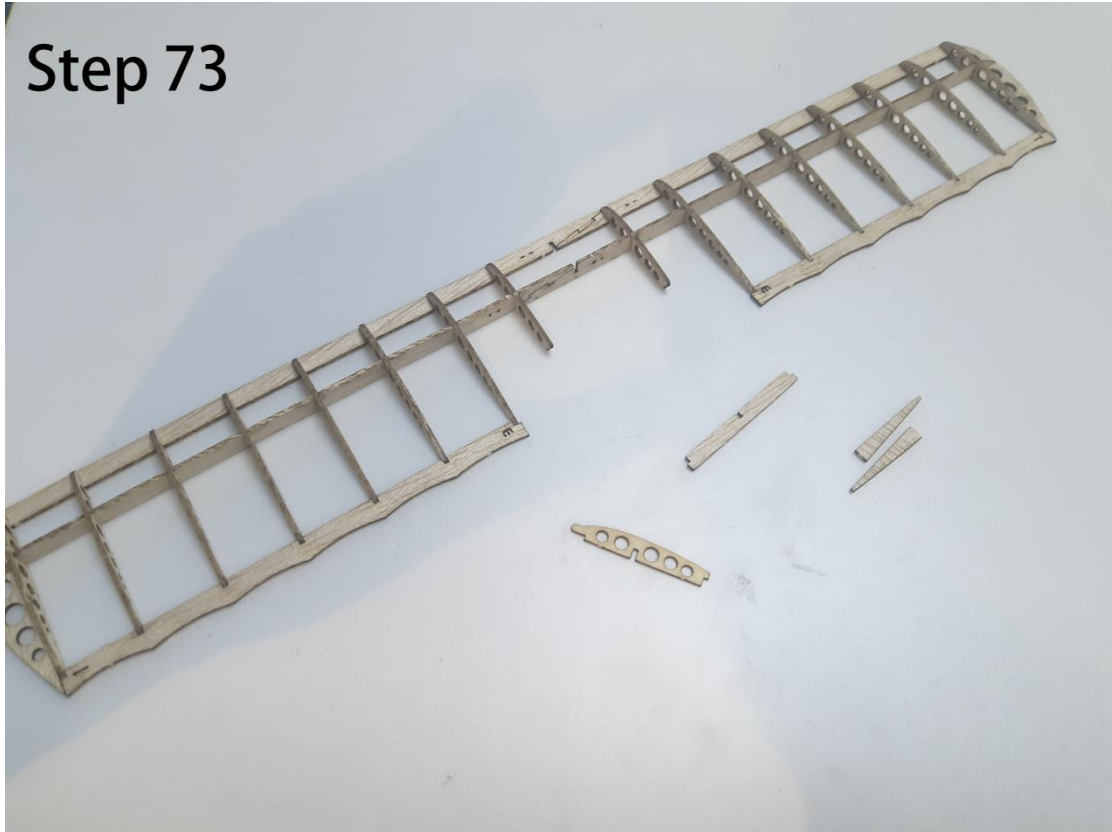

Step 74

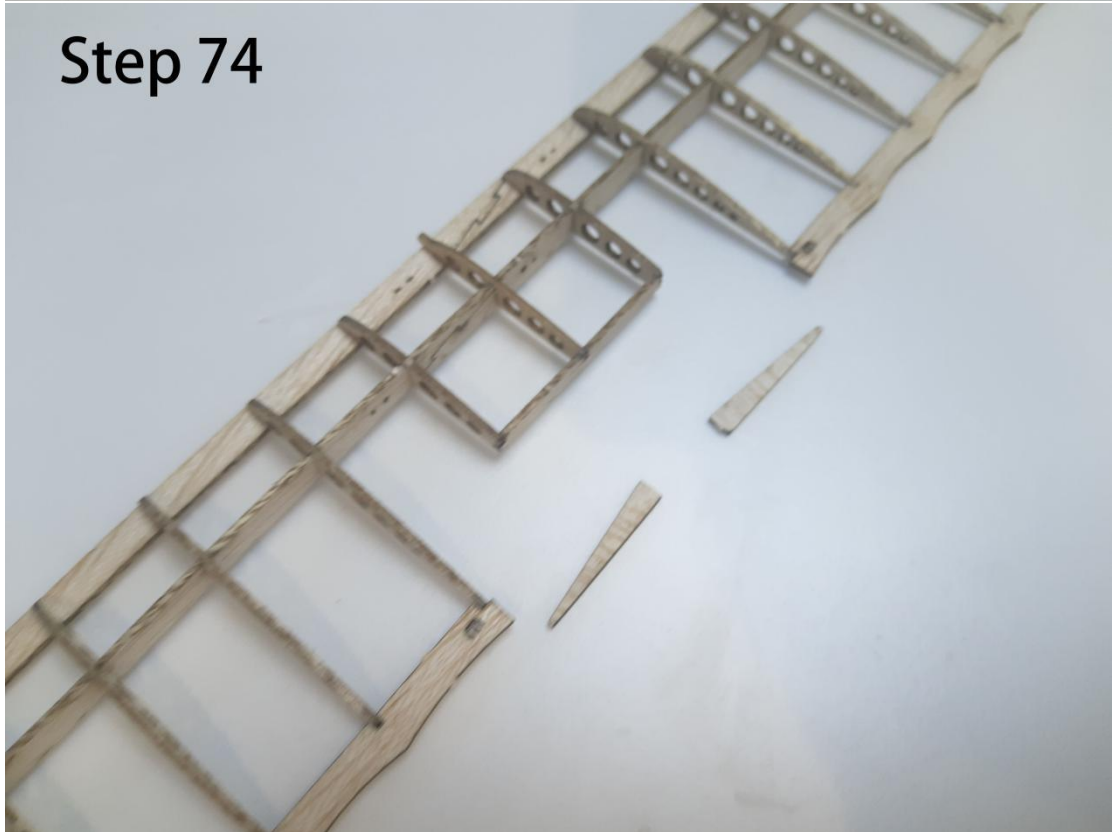

Step 75

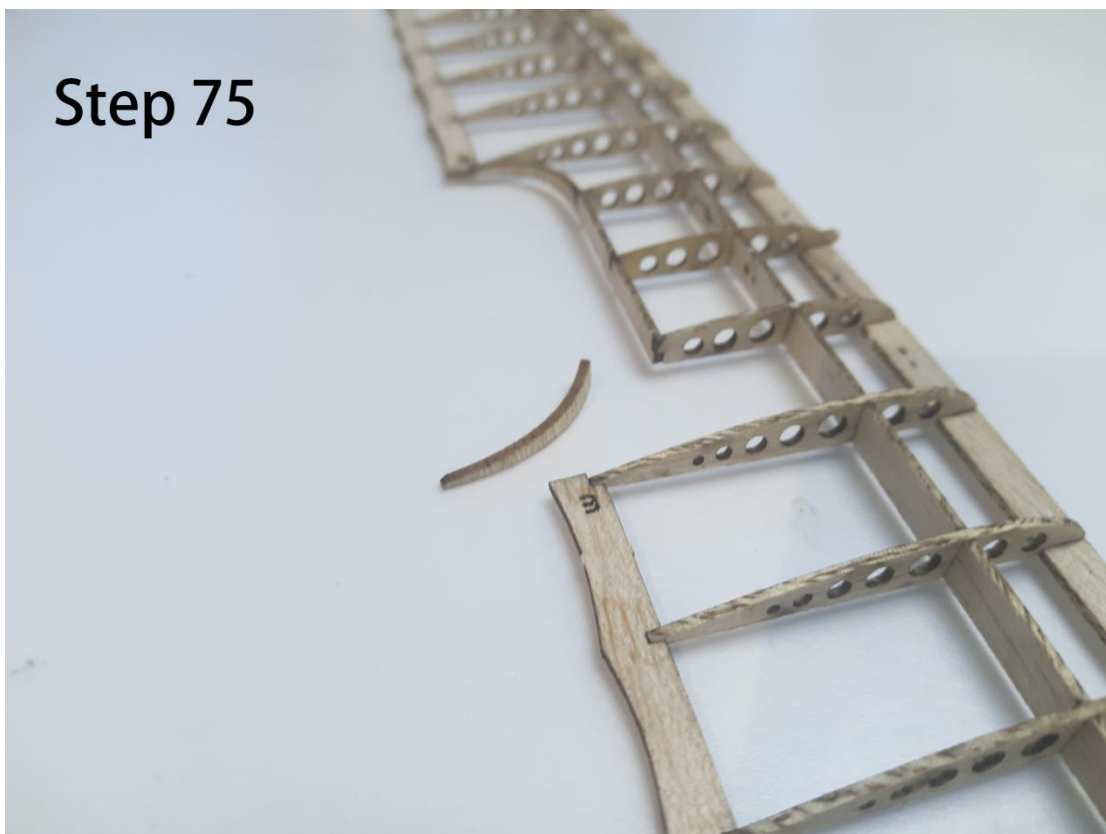

Step 76

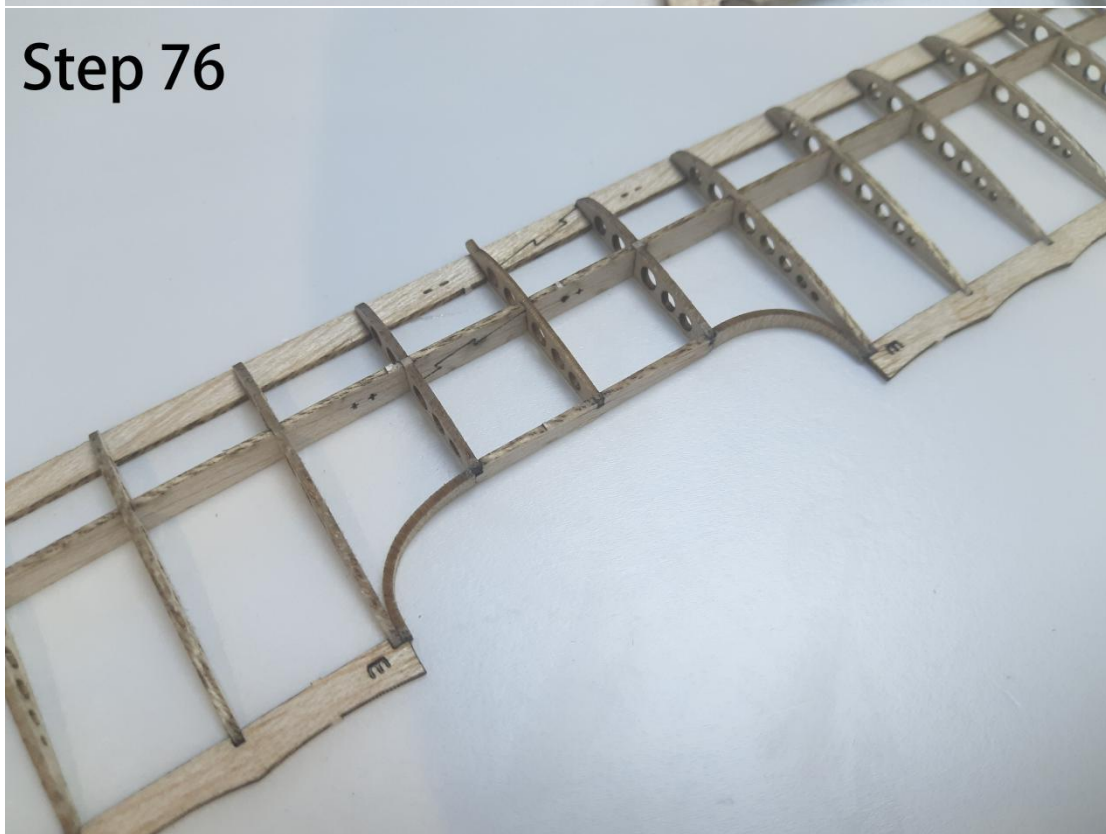

Step 77

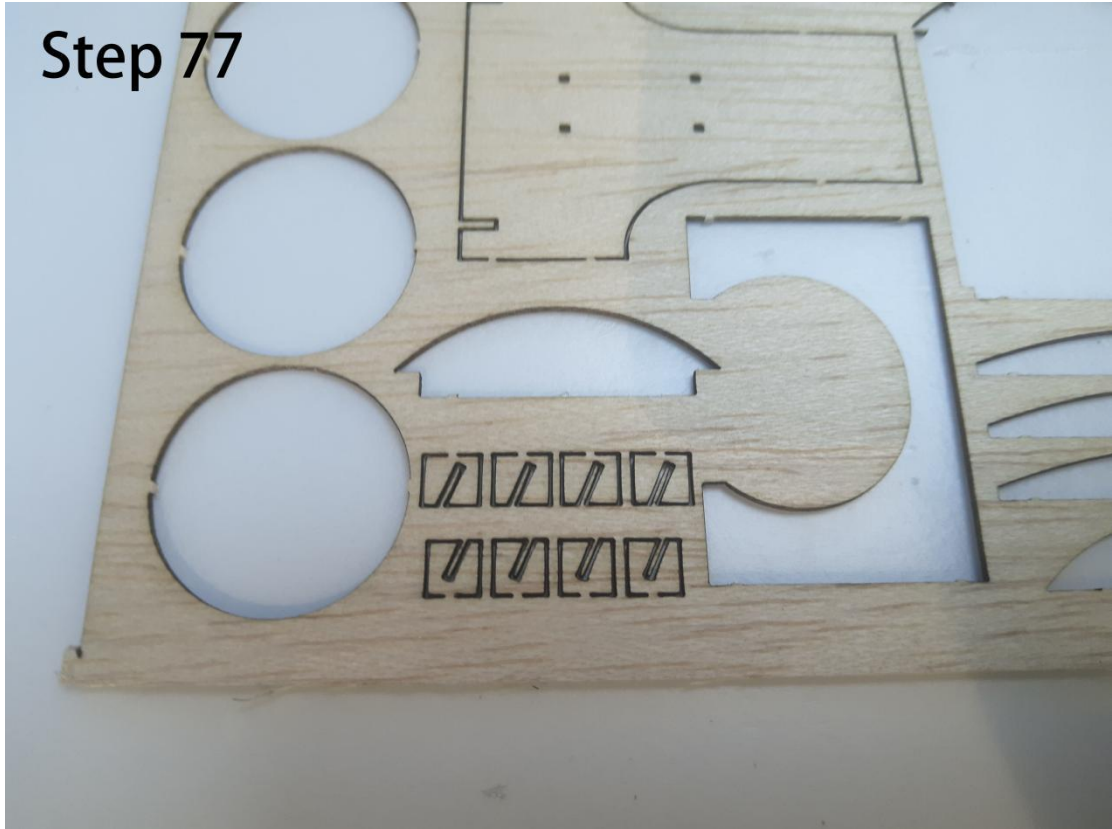

Step 78

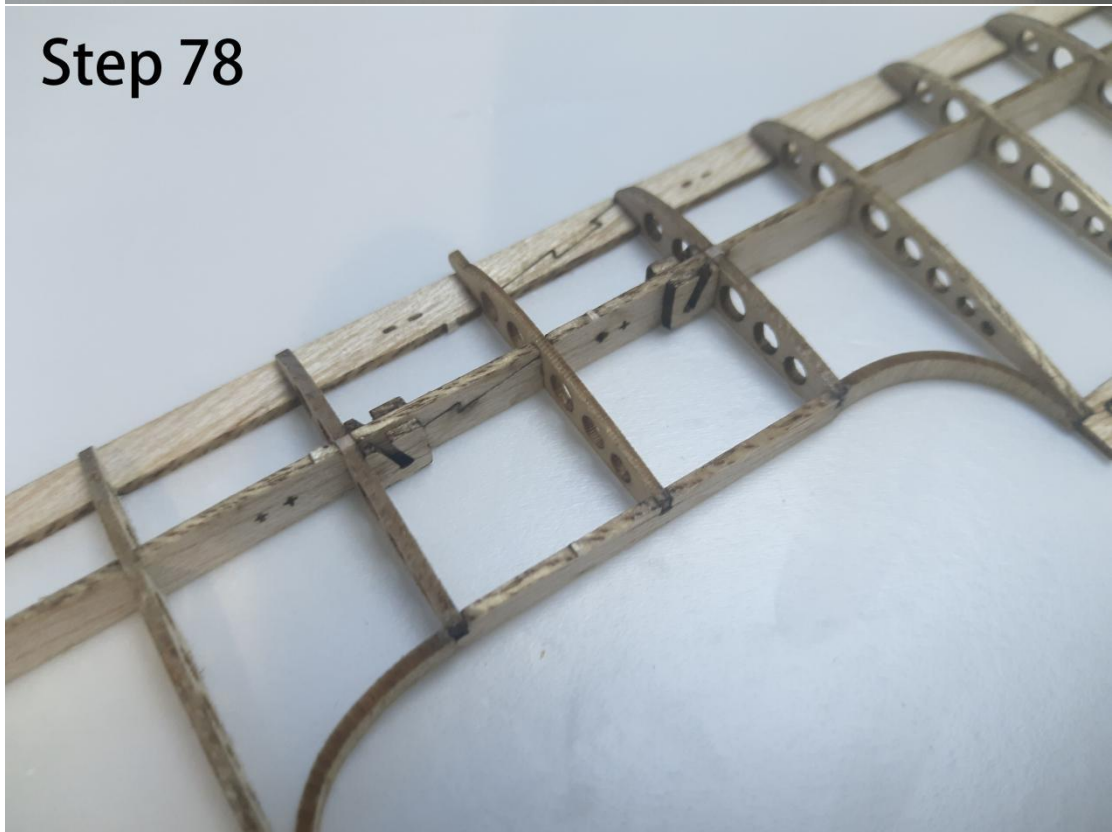

Step 79

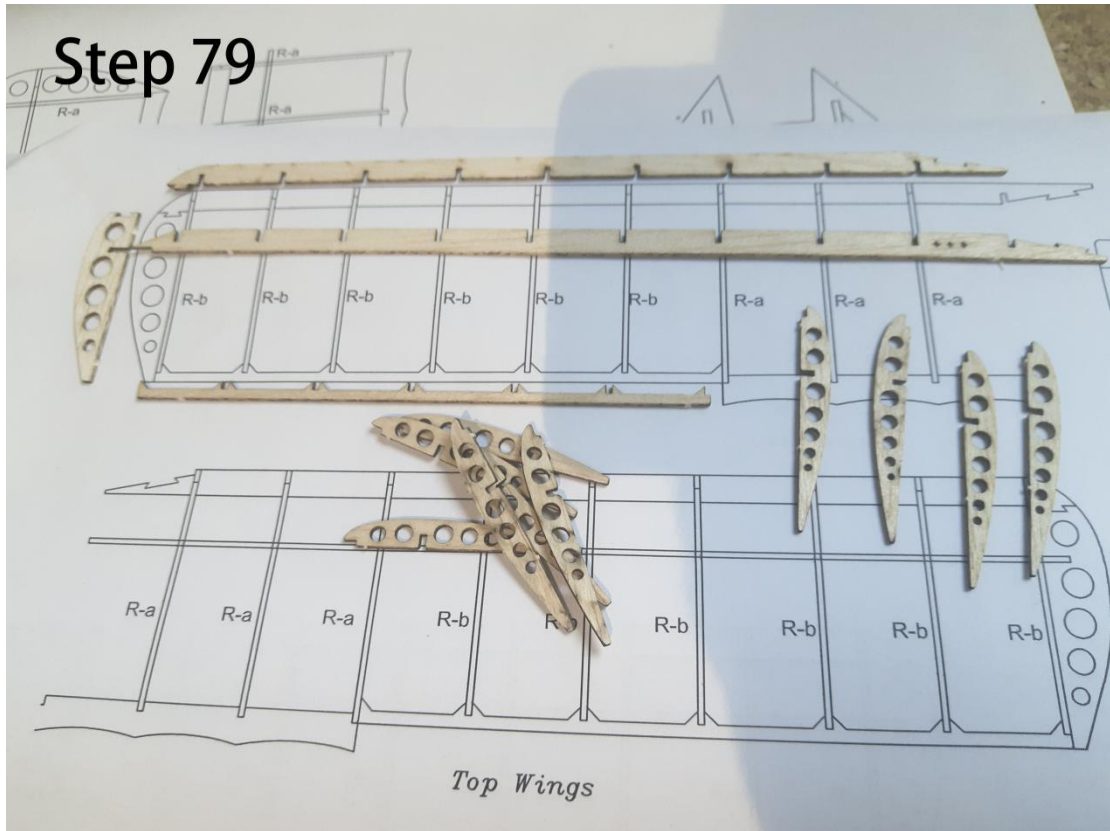

Step 80

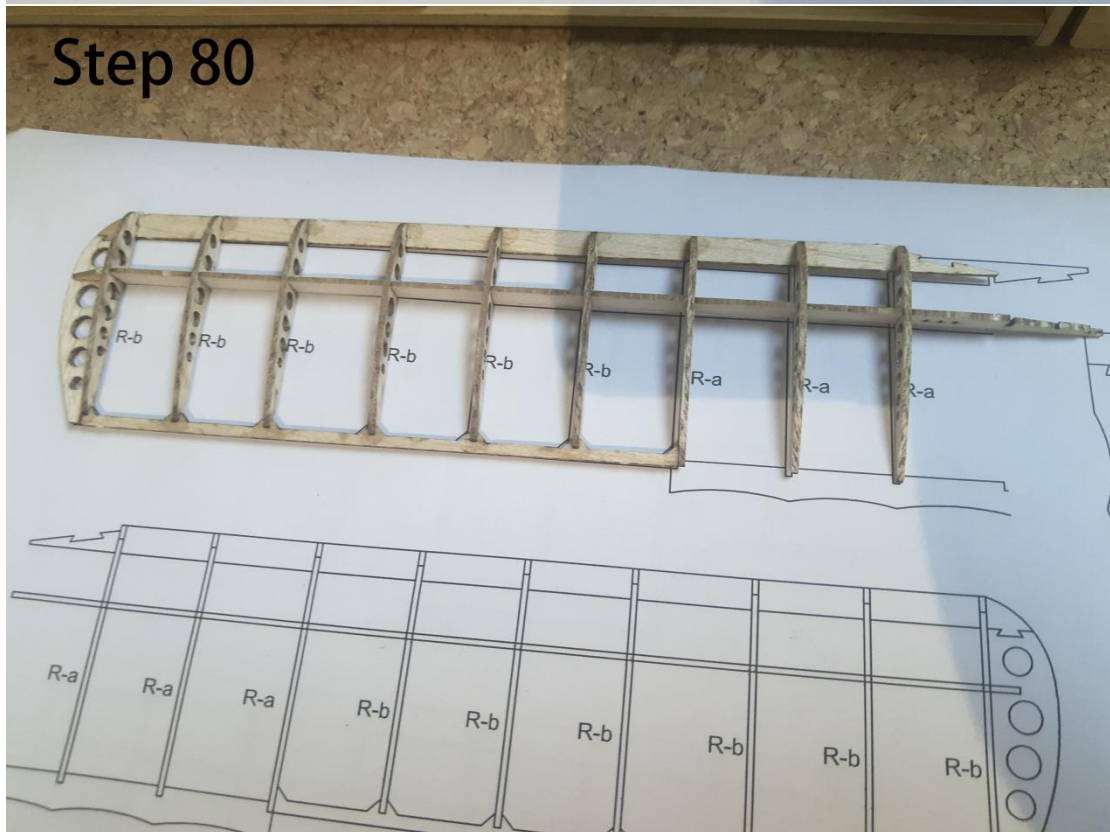

Step 81

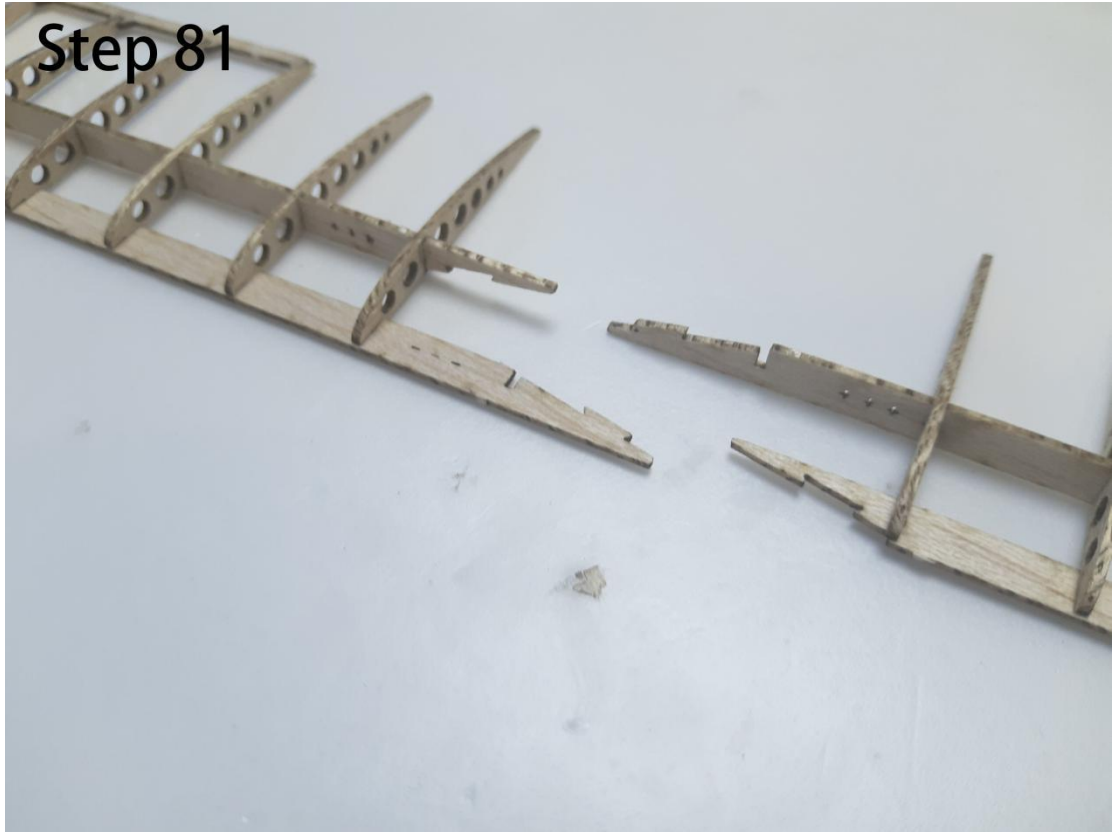

Step 82

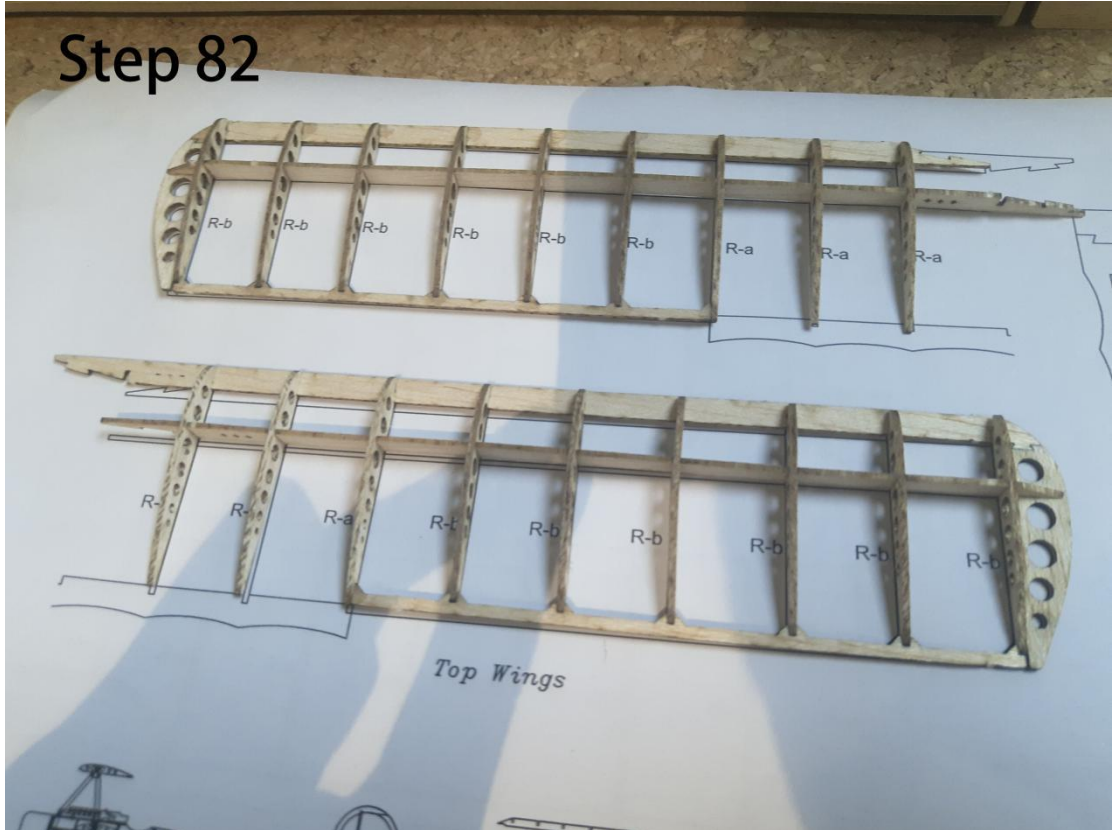

Step 83



Step 84



Step 85



Step 86

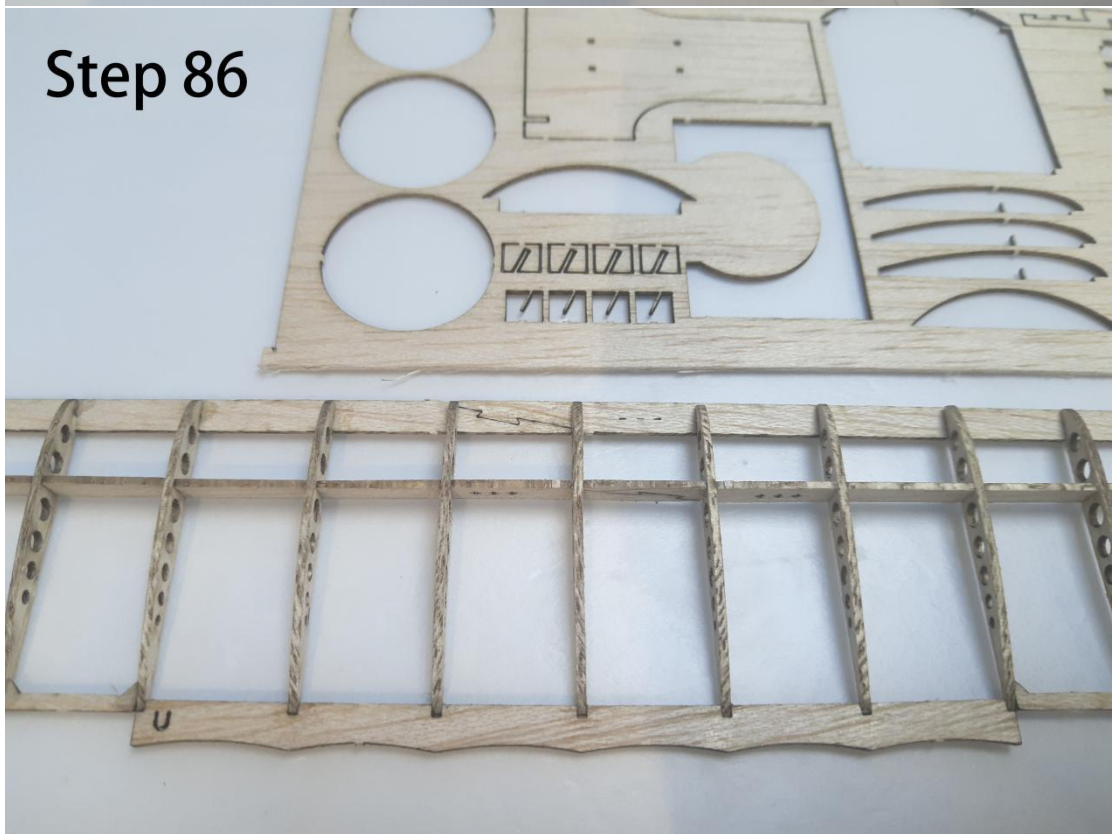

Step 87

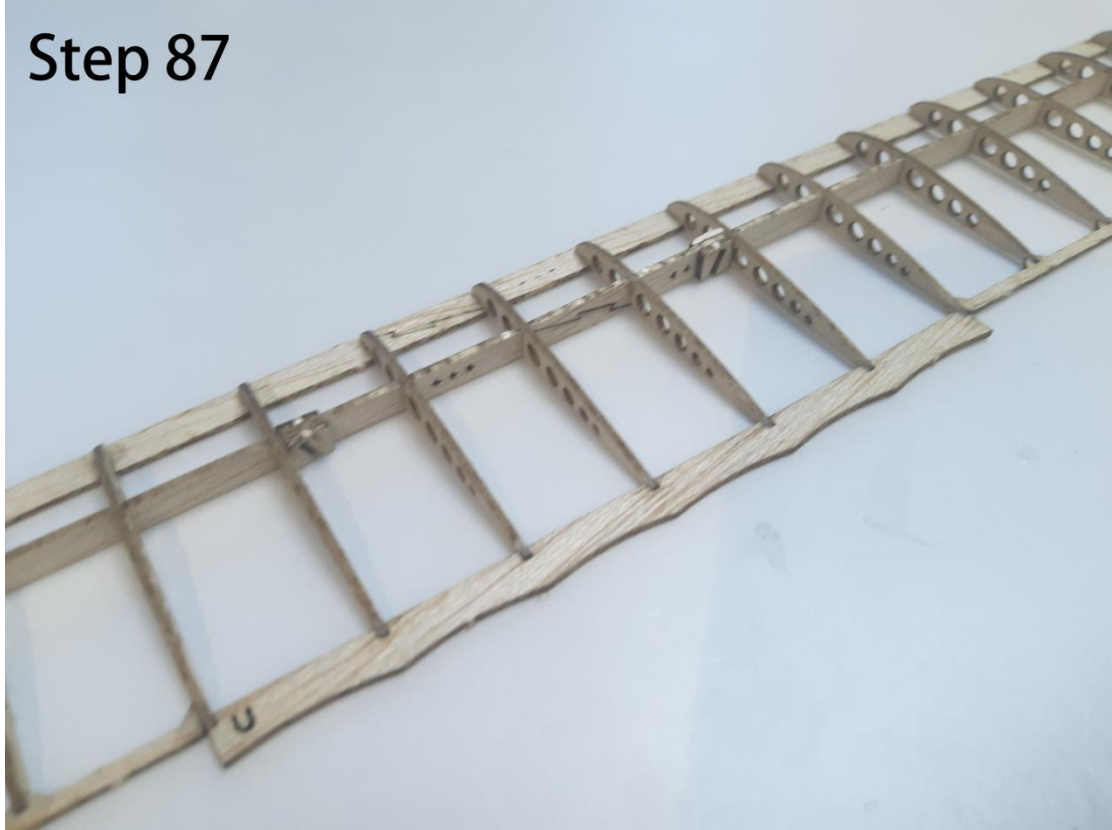

Step 88

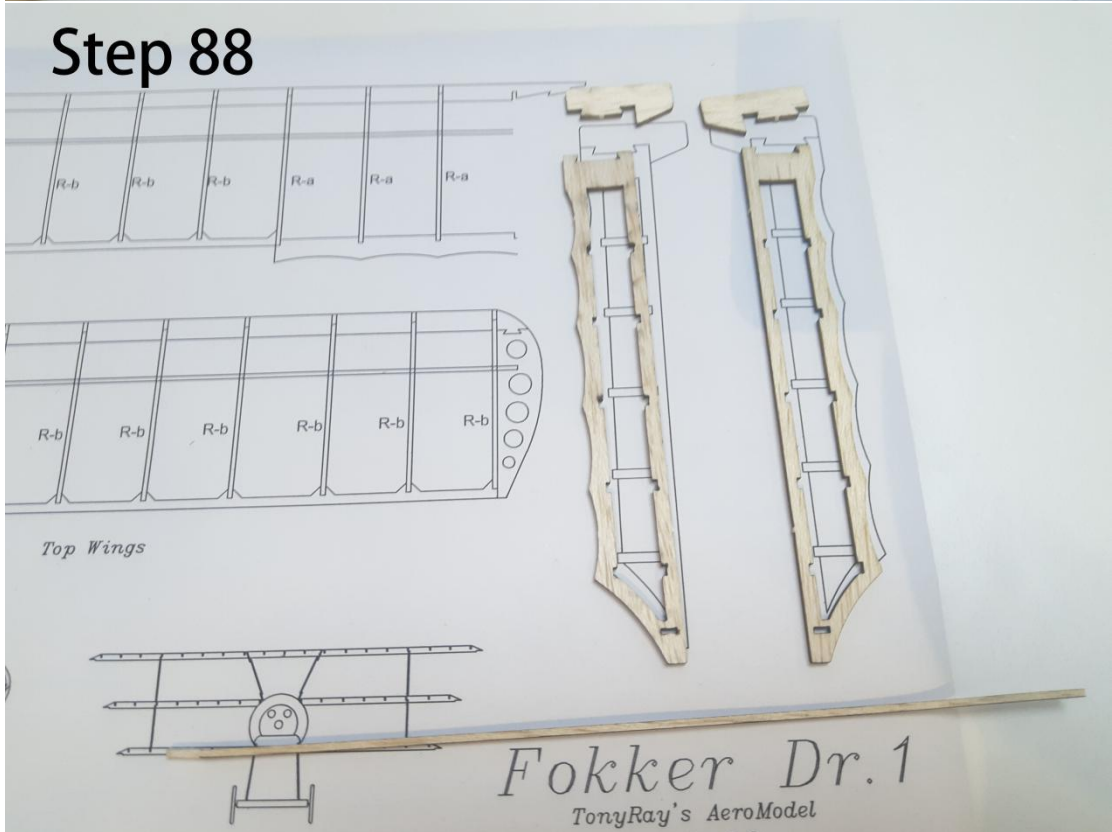

Step 89

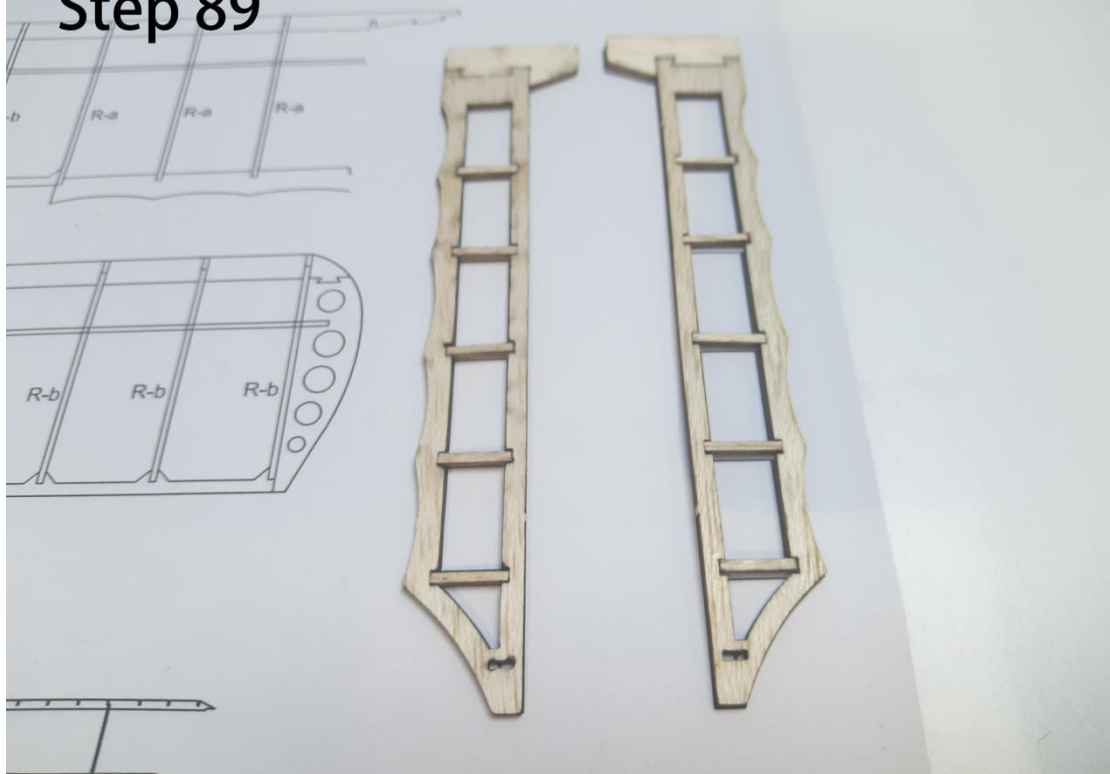

Step 90

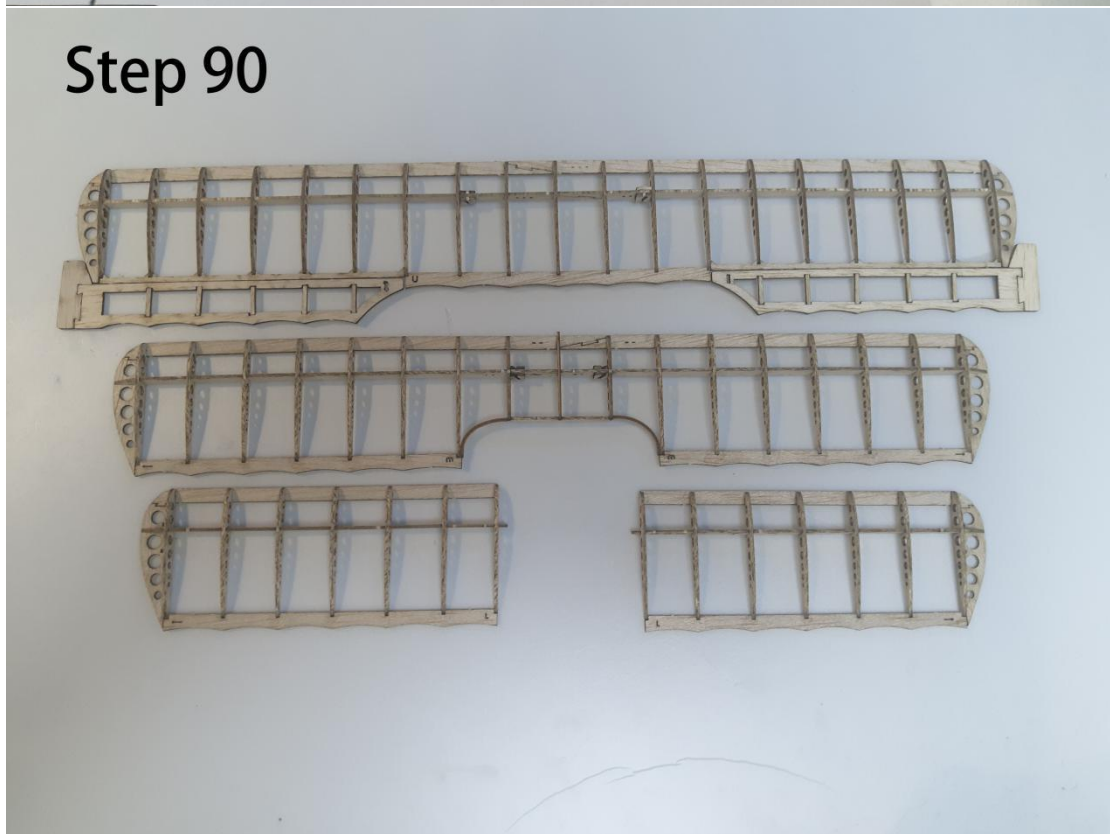

Step 91



Step 92



Step 93



Step 94

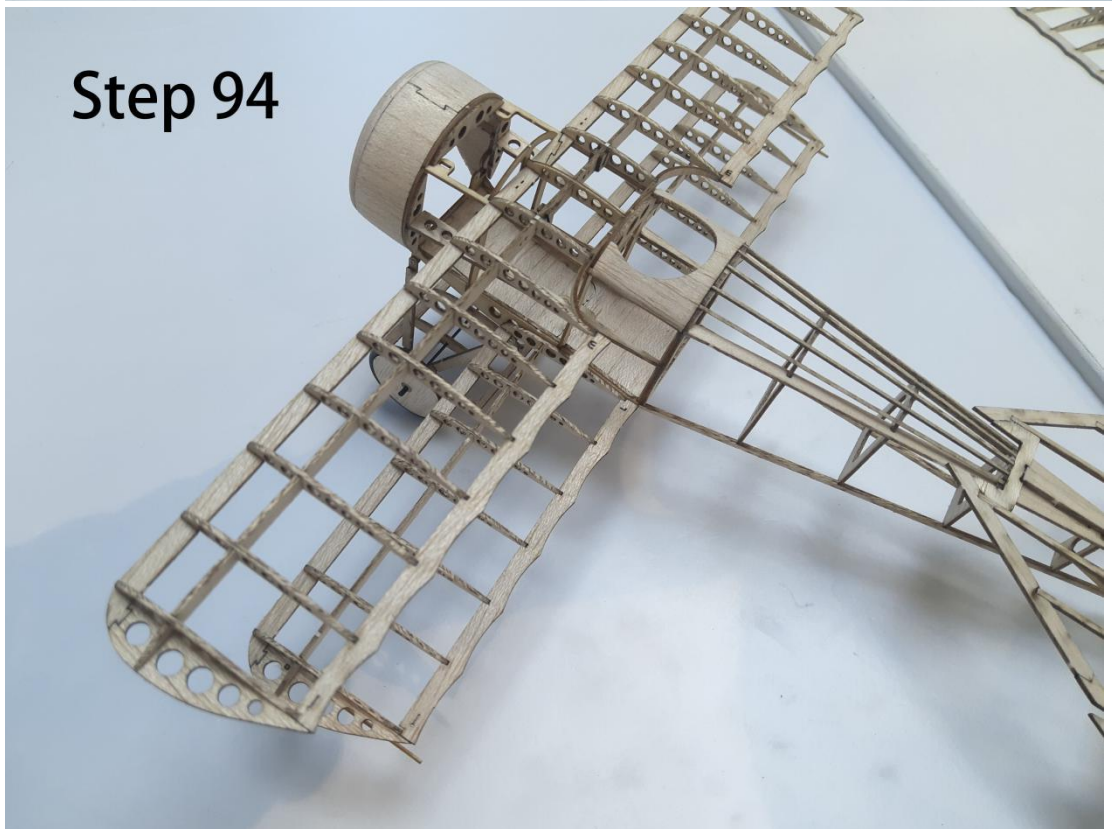

Step 95



Step 96



Step 97

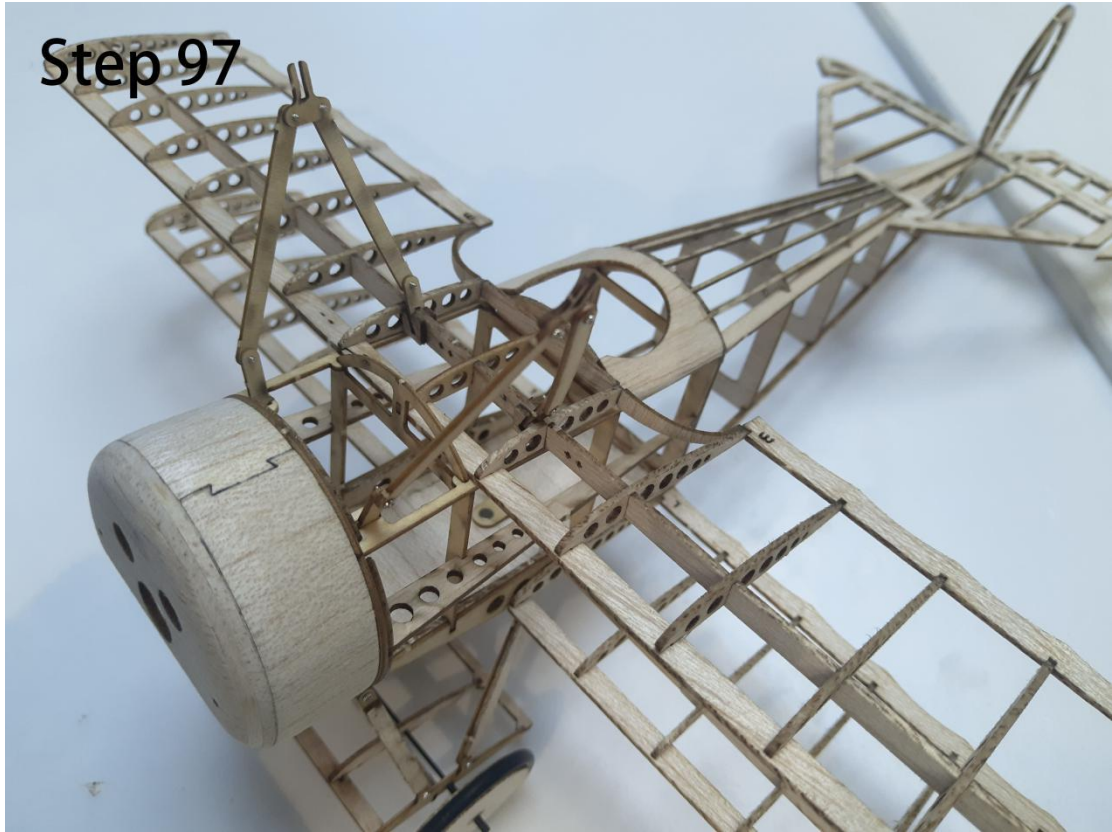

Step 98



Step 99

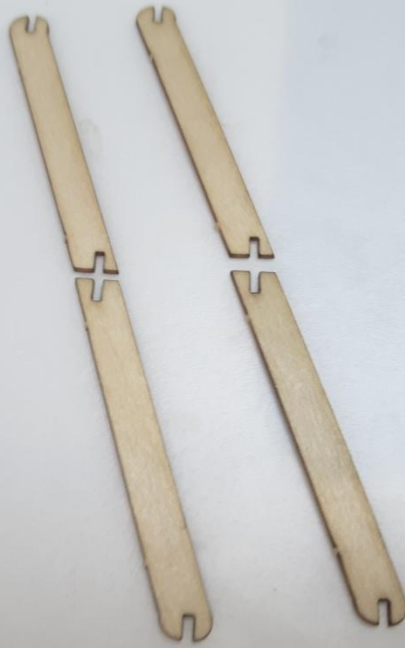

Step 100



Step 101



Step 102

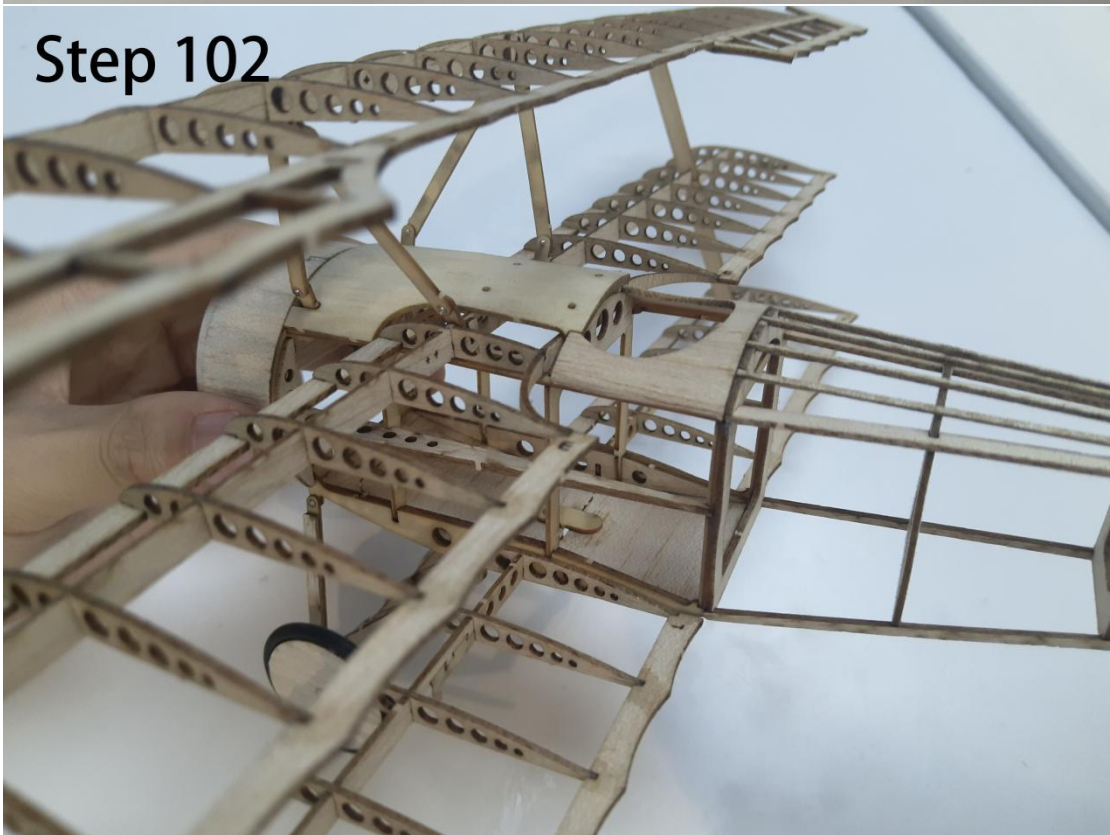

Part2: Accessories

Step1

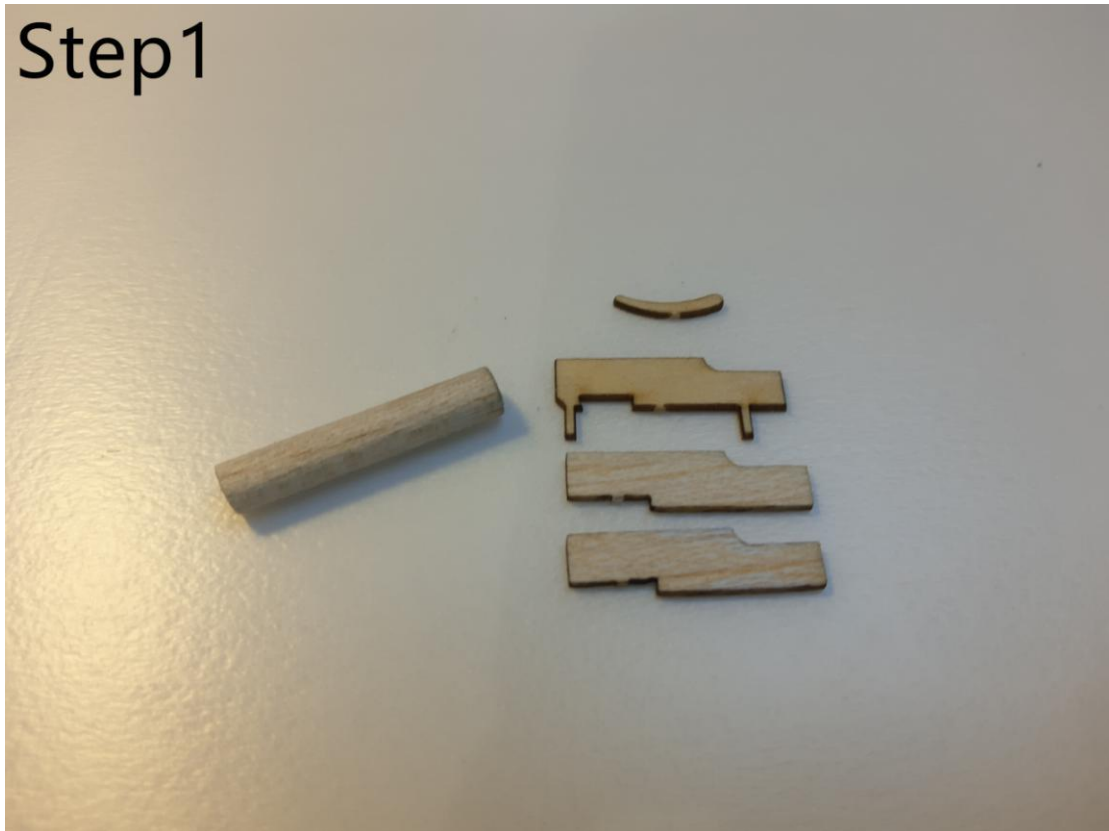

Step2



Heat shrink tube(have been shrinked)

Step3



Build another one in the same way

Step4



Step5



Step6

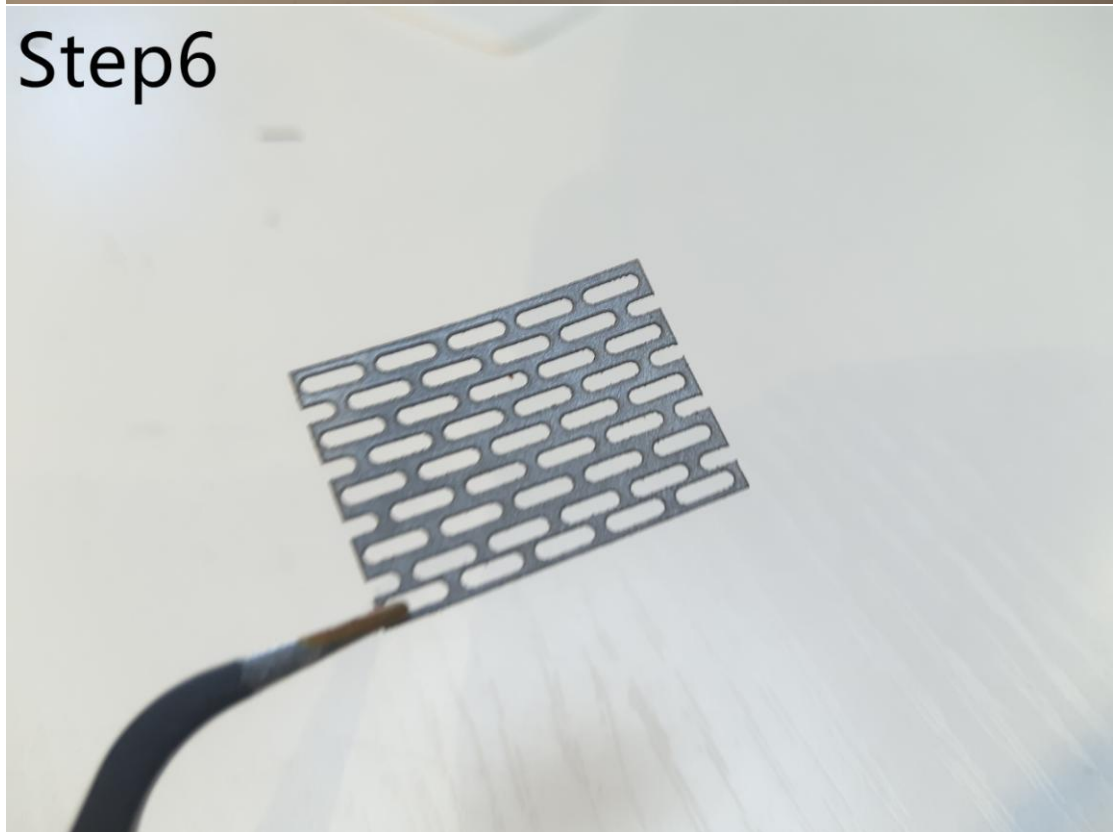

Step7

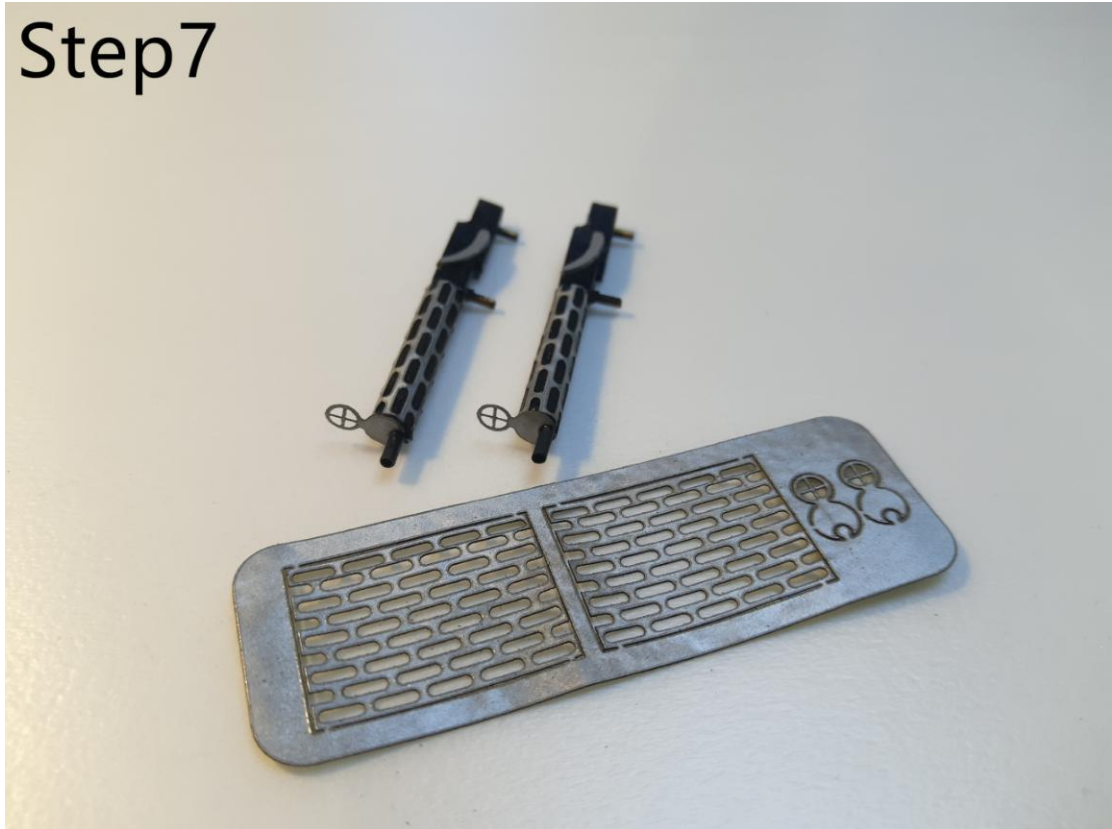

Part3: Electronics

Step1



Step2

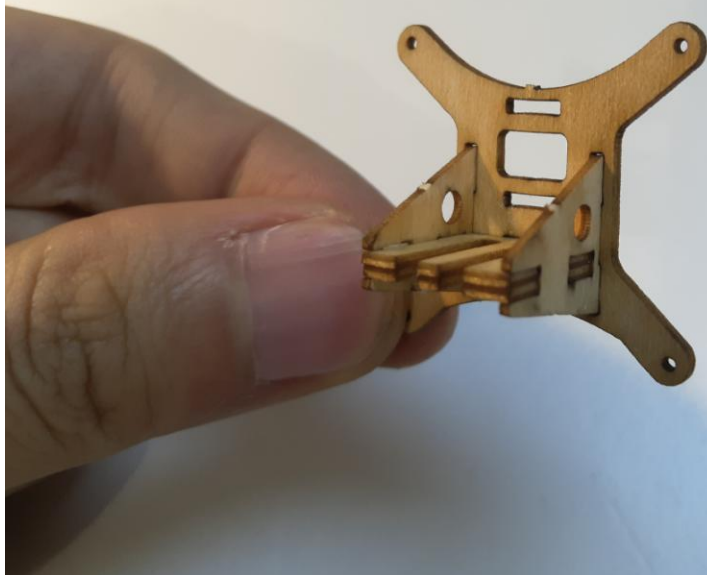

Step3

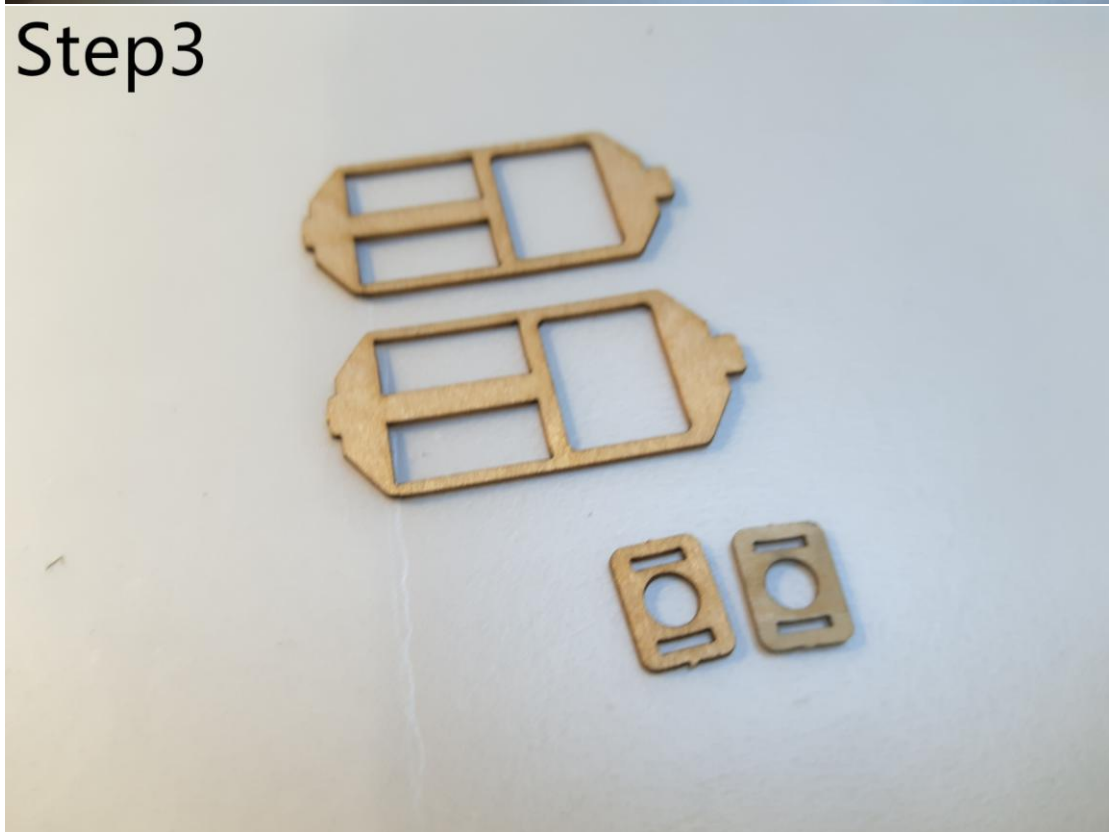

Step4

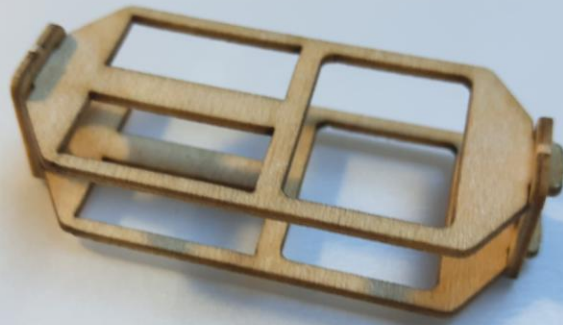

Step5



Step6

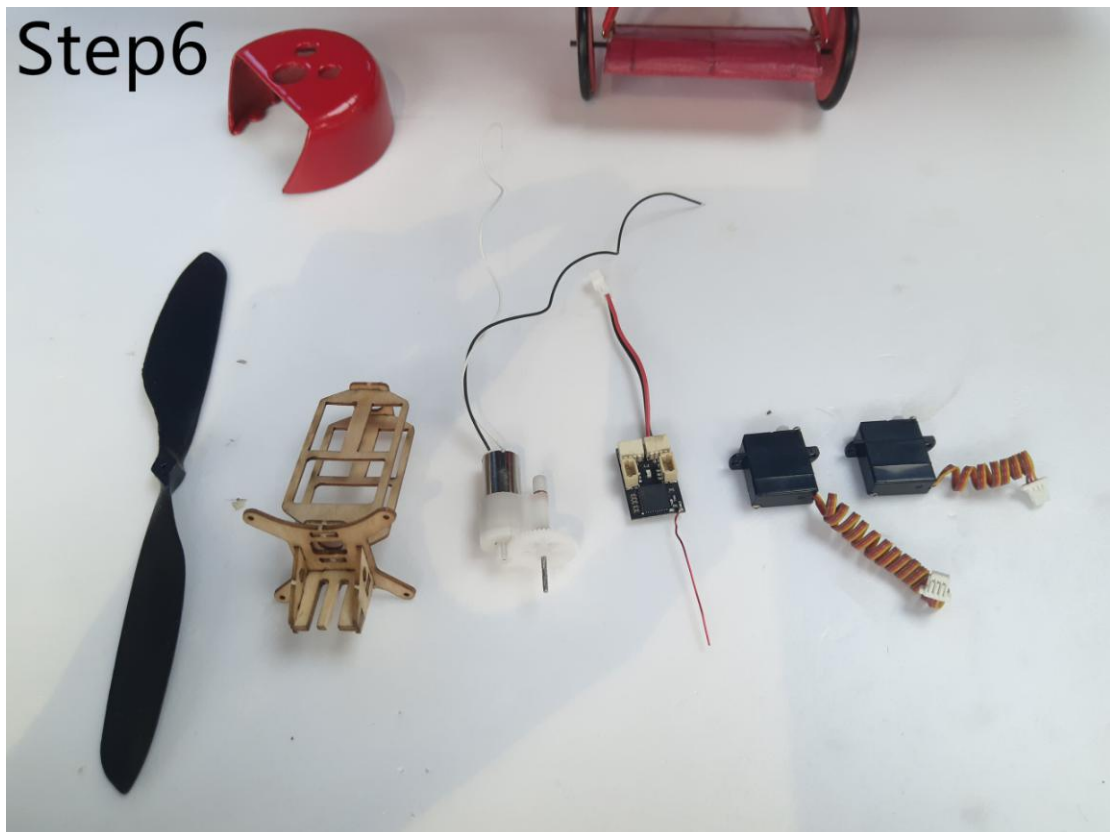

Step7

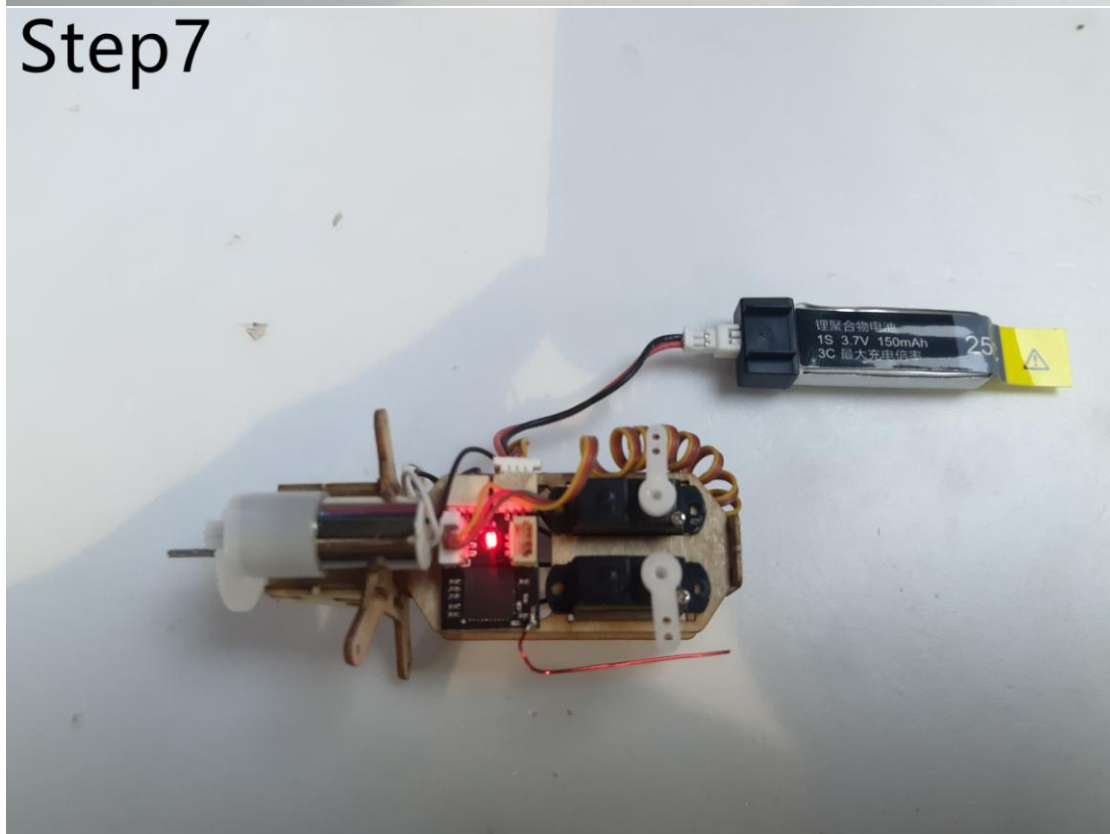

Step8

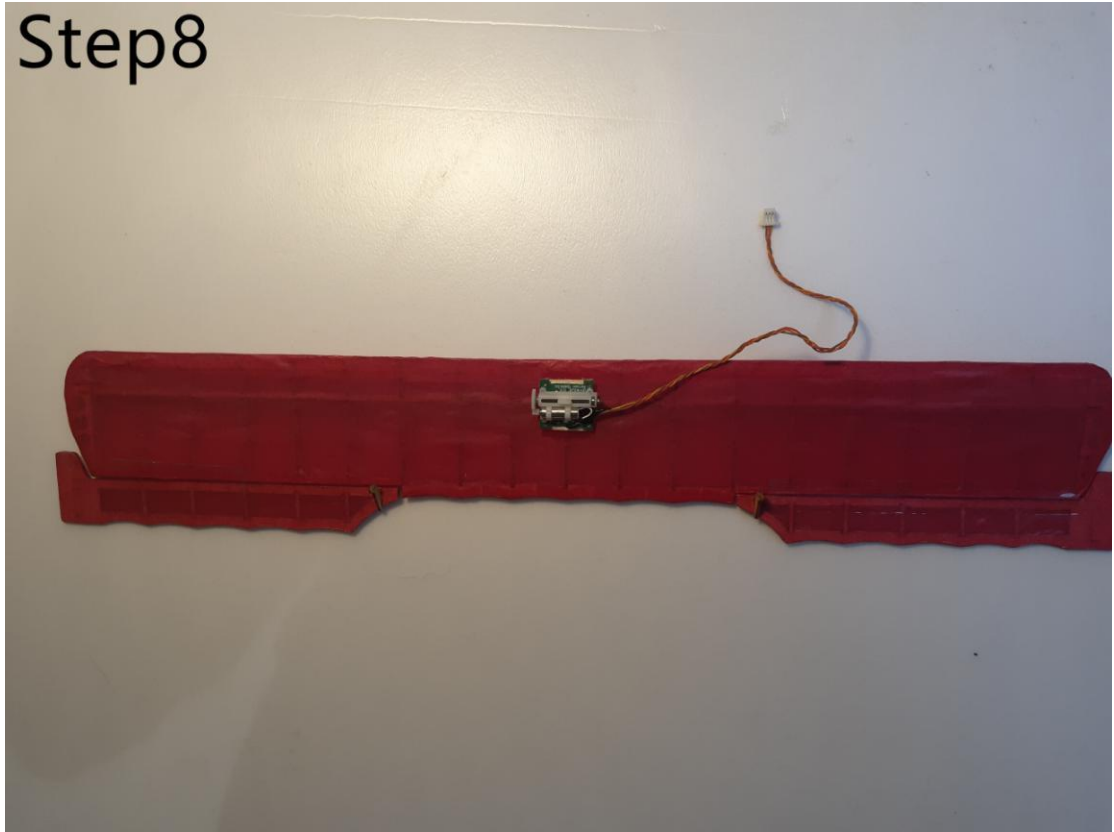

Step9

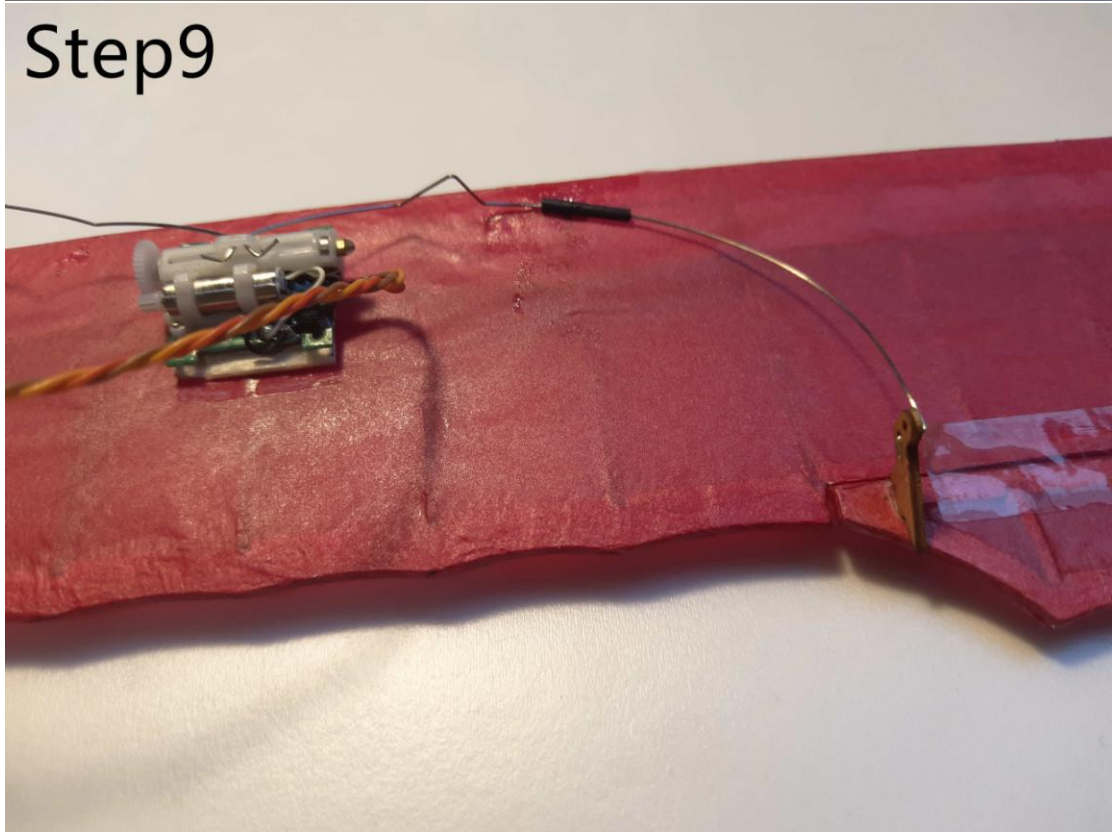

Step10

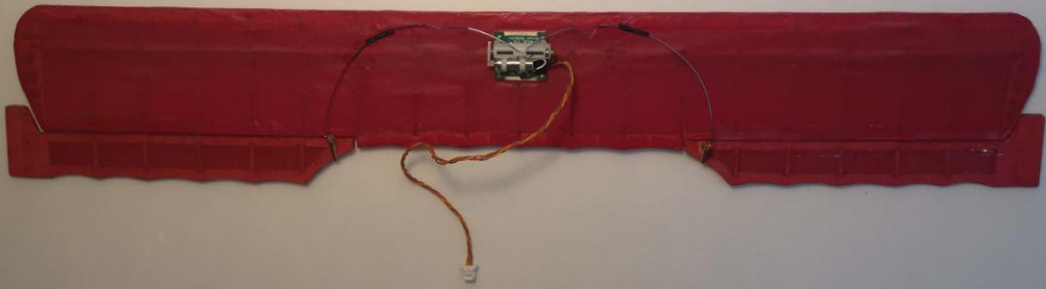

Step11





Thank you for your purchase.



Tony Ray's AeroModel



Micro scale series of TonyRay Aero Model Co.,Ltd

If you have any trouble or feedback, Please contact us

mailbox : 2721100643@qq.com