

UNI-T®

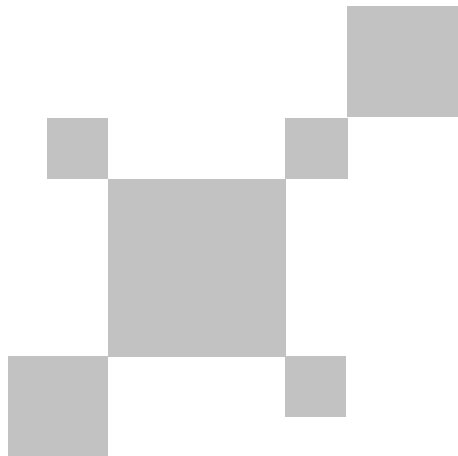

P/N:



UTi690A

红外热成像仪

Professional Thermal Imager

UTi690A
红外热成像仪使用说明书

P3-P18

UTi690A
Professional Thermal Imager
User Manual

P20-P36

序言

尊敬的用户：

您好！感谢您选购全新的UTi690A热成像仪，为了正确使用本产品，请您在使用之前仔细阅读本说明书全文，特别是有关“安全注意事项”的部分。

如果您已经阅读完本说明书全文，建议您将此说明书妥善保管，与热成像仪一同放置或者放在您随时可以查阅的地方，以便在将来的使用过程中查阅。

有限担保和有限责任

公司担保本产品自购买之日起一年内，在材料和工艺上均无任何缺陷。本担保不适用由于意外、疏忽、误用、改装、污染及非正常操作或处理引起的损坏。经销商无权以公司的名义给予其它任何担保。如在保修期内需要保修服务，请与您就近的授权服务中心联系，获得产品退还授权信息；然后将产品寄至该服务中心，并附上产品问题描述。

本项担保是您能获得的唯一补偿。除此以外，公司不提供任何明示或隐含的担保，例如适用于某一特殊目的的隐含担保。同时，公司不对基于任何原因或推测而导致的任何特殊、间接、附带或继起的损坏或损失负责，由于某些州或国家不允许对默示担保及附带或继起的损坏加以限制，故上述的责任限制与规定或许对您不适用。

目录

1. 性能指标	5
2. 构造	7
3. 显示说明	8
4. 开关机	8
5. 配置菜单说明	9
6. 图片浏览	9
7. 温度标记	10
8. 高低温报警	10
9. 手电筒功能	11
10. 调色板样式选择	11
11. 中英文切换	12
12. 摄氏度和华氏度切换	12
13. 发射率	13
14. 激光	13
15. 时间和日期	14
16. 屏幕亮度	14
17. 自动光机	15
18. 自动存储	15
19. 格式化SD卡	16
20. 设备讯息	16
21. 恢复出厂设置	17
22. USB通信及PC软件分析	17
23. 保养	17
24. 安全须知	17
25. 附录	18

1. 性能指标

探测器类型	非制冷氧化钒
像元间距	17μm
响应波段	8~14μm
红外分辨率	120 x 90 像素
热灵敏度 (NETD)	<60mK
视场角 (FOV)	50° (H) x 38° (V)
空间分辨率 (IFOV)	7.6 mrad
帧频	≤25Hz
最小成像距离	0.1m
调焦	免调焦
测温范围	-20°C~400°C
测温精度	±2%或±2°; 取最大值 (-10°C~400°C, 常温25°C)
测温单位	摄氏度、华氏度
测温分辨率	0.1°C
发射率	0.95 (默认) (0.01~0.99可调)
测温显示	中心点测温、高低温追踪
色板	熔岩、高对比度彩虹、黑热、白热、铁红、彩虹
显示屏	2.4" TFT LCD
显示屏分辨率	320 x 240
按键	4个按键(电源键、上键、下键、OK键)、1个扳机键
激光指示	有(2级)
LED照明灯	有

温度报警	屏幕报警、LED照明灯报警、蜂鸣器报警
图像存储	Micro SD卡
图像格式	BMP
PC分析软件	有
数据通讯	Type-C USB
电池类型	可充锂电池 (3.7V / 2600mAh)
电池工作时长	连续使用时间 >9小时
充电时间	≤2.5小时
充电电压/电流	5V / 2A
开机速度	0s (休眠唤醒) / 5s (开机)
自动关机	30分钟 (默认) (可选 5分钟、10分钟、30分钟、关)
工作温度	0~50°C (32~140°F)
存储温度	-20~60°C (-4~140°F)
工作湿度	<85%RH (非冷凝)
IP等级	IP54
跌落	2m
产品尺寸	197 x 72 x 60 mm
产品重量	310g
认证	CE、UKCA、RoHS
配件	说明书、Type-C USB线、16GB Micro SD卡

2. 构造

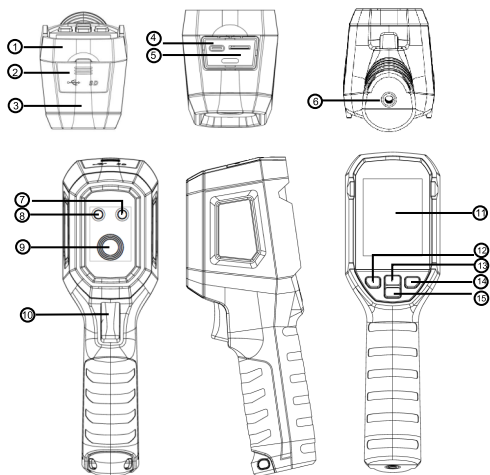

项目	说明	项目	说明
1	上壳	9	红外热像窗口
2	接口防护盖	10	拍照 扳机键
3	下壳	11	液晶显示屏
4	USB Type-C接口	12	OK键
5	SD卡槽	13	上键
6	支架固定螺孔	14	电源键
7	激光发射窗口	15	下键
8	手电筒窗口		

3. 显示说明

- 屏幕尺寸：2.4" (495mm x 377m)
- 显示器分辨率：320 (垂直) x 240 (水平)

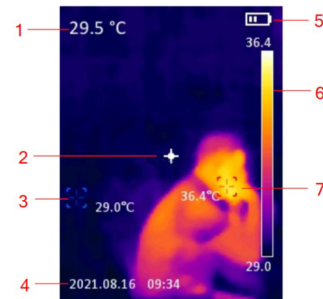

项目	说明
1	测量中心点温度
2	测量中心点
3	当前自动追踪温度最小点
4	日期时间
5	电池电量指示
6	调色板
7	当前自动追踪温度最大点

4. 开关机

当机器处于关机状态时，长按电源键3秒钟，热像仪开机；当机器处于待机状态时，短按电源键1秒钟，热像仪开机。

当机器处于开机状态时，短按电源键1秒钟，热像仪进入待机状态；长按电源键8秒钟，屏幕提示“正在关机”热像仪进入关机状态。

5. 配置菜单说明

短按OK键，进入主菜单界面，主菜单选项如下：



6. 图片浏览

在主菜单界面选中图片浏览，短按OK键进入图片浏览选项。在此选项中，可按上下键选中某一张图片。进入该图片后，可按OK键查看图片讯息，也可按上下键选中删除按钮，选择是否删除图片。



7. 温度标记

在主菜单界面短按上下键选中温度标记，短按OK键进入温度标记选项。在此选项中，可设置中心点/高低温点/调色板/日期&时间 这四项功能打开与关闭。例如，选中中心点，按OK键设置打开与关闭该功能。



8. 高低温报警

在主菜单界面短按上下键选中高低温报警，短按OK键进入高低温报警设置选项。在此选项中，可设置温度报警功能打开与关闭，蜂鸣器打开与关闭，高温报警值和低温报警值。



9. 手电筒功能

在主菜单界面短按上下键选中手电筒，短按OK键可选择手电筒功能打开与关闭。



10. 调色板样式选择

在主菜单界面短按上下键选中调色板，短按OK键进入调色板样式选择界面。在此界面中，可以短按上下键依次选择彩虹、铁红、白热、黑热、高对比度彩虹、熔岩等六个样式，短按OK键确定选中的样式，此时短按电源键退出主菜单，可以看到热像界面呈现出所选择的样式。

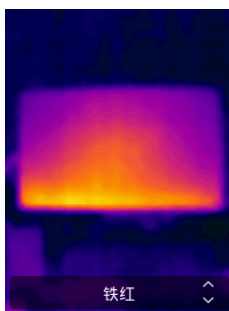

11. 中英文切换

在主菜单界面短按上下键选中设置，短按OK键进入设置二级菜单界面。选中语言选项，短按OK键进入中英文切换界面。



12. 摄氏度和华氏度切换

在主菜单界面短按上下键选中设置，短按OK键进入设置二级菜单界面。短按上下键选中温度单位，短按OK键进入摄氏度和华氏度单位切换界面。

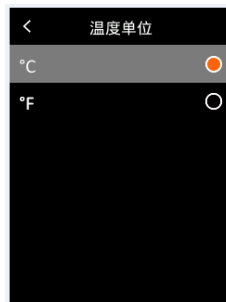

13. 发射率

在主菜单界面短按上下键选中设置，短按OK键进入设置二级菜单界面。短按上下键选中发射率，短按OK键进入发射率数值设置界面。



14. 激光

在主菜单界面短按上下键选中设置，短按OK键进入设置二级菜单界面。短按上下键选中激光，短按OK键可以选择激光功能打开与关闭。



15. 时间和日期

在主菜单界面短按上下键选中设置，短按OK键进入设置二级菜单界面。短按上下键选中时间&日期，短按OK键进入时间和日期设置界面，其中时间格式可以切换12H和24H。设置时间和日期时，按上下键调整数值，短按OK键确定。设置完毕后，短按电源键返回上级菜单。



16. 屏幕亮度

在主菜单界面短按上下键选中设置，短按OK键进入设置二级菜单界面。短按上下键选中屏幕亮度，短按OK键进入屏幕亮度设置界面，在此界面中短按上下键和OK键可以将屏幕亮度设置为低中高挡。

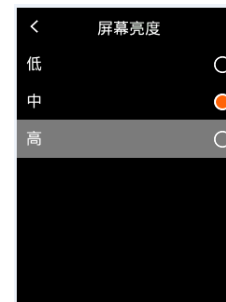

17. 自动关机

在主菜单界面短按上下键选中设置，短按OK键进入设置二级菜单界面。短按上下键选中自动关机，短按OK键进入自动关机设置界面，在此界面中短按上下键和OK键可以选择在5分钟/10分钟/30分钟内对机器无操作后自动关机，以及关闭自动关机功能。



19. 格式化SD卡

在主菜单界面短按上下键选中设置，短按OK键进入设置二级菜单界面。短按上下键选中格式化SD卡，短按OK键进入格式化SD卡选项，选择是否对SD卡进行格式化。

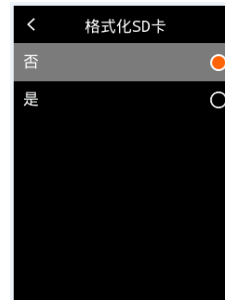

18. 自动存储

在主菜单界面短按上下键选中设置，短按OK键进入设置二级菜单界面。短按上下键选中自动存储，短按OK键选择自动存储功能打开与关闭。



20. 设备讯息

在主菜单界面短按上下键选中设置，短按OK键进入设置二级菜单界面。短按上下键选中设备讯息，短按OK键进入，可以查看设备讯息，包括设备型号、固件版本、存储容量及剩余空间。



21. 恢复出厂设置

在主菜单界面短按上下键选中设置，短按OK键进入设置二级菜单界面。短按上下键选中恢复出厂设置，短按OK键进入，可以选择是否恢复出厂设置。

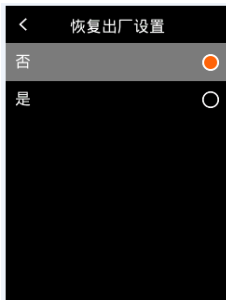

22. USB通信及PC软件分析

1. 请参照下载指南下载上位机软件并完成安装。
2. 将USB数据线与电脑连接，可以浏览图片和通过上位机软件分析数据。
3. 关于上位机软件的使用方法，可以从操作界面的帮助选项中调取《软件用户手册》提供操作帮助。
5. 在USB通信时，请勿直接拔掉USB线，设备和电脑已连接成功，如要断开设备要正确移除电脑连接（在电脑右下角选中移除设备）。

23. 保养

用湿布或弱肥皂液清洗结构外壳，不要使用研磨剂、异丙醇或溶剂清洁仪器外壳镜头/窗口。

24. 安全须知

为了保证测量结果准确，请仔细阅读使用说明。请务必按照说明书使用本产品，否则造成产品损坏后将不进行免费保修。请不要在易燃易爆、蒸汽周围、潮湿或腐蚀性环境下使用本仪器。请不要在仪器损坏、摔落或修正后的情况下继续使用，以免造成错误的测试结果。请参考辐射系数信息获取实际温度，否则会导致测得的温度不准确。由于充电会引起机体内温度升高，从而影响温度测量精度。因此，建议在对本产品充电时不要进行温度测量。

25. 附录

常用发射率

材质	发射率	材质	发射率
木	0.85	黑纸	0.86
水	0.96	聚碳酸	0.8
砖	0.75	混凝土	0.97
不锈钢	0.14	氧化铜	0.78
胶带	0.96	铸铁	0.81
铝板	0.09	锈	0.8
铜板	0.06	石膏	0.75
黑铝	0.95	油漆	0.9
人体皮肤	0.98	橡胶	0.95
沥青	0.96	土壤	0.93
PVC塑料	0.93		

优利德®

优利德科技(中国)股份有限公司

地址：广东省东莞市松山湖园区工业北一路6号

电话：(86-769) 8572 3888

邮编：523 808

http://www.uni-trend.com.cn

Preface

Thank you for purchasing the new UTi690A thermal imager. In order to use this product safely and correctly, please read this manual thoroughly, especially the *Safety Instructions* part.

After reading this manual, it is recommended to keep the manual at an easily accessible place, preferably close to the device, for future reference.

Limited Warranty and Liability

Uni-Trend guarantees that the product is free from any defect in material and workmanship within one year from the purchase date. This warranty does not apply to damages caused by accident, negligence, misuse, modification, contamination or improper handling. The dealer shall not be entitled to give any other warranty on behalf of Uni-Trend. If you need warranty service within the warranty period, please contact your seller directly.

Uni-Trend will not be responsible for any special, indirect, incidental or subsequent damage or loss caused by using this device.

Table of Contents

1. Specifications	22
2. Structure	24
3. LCD Indicators/Icons	25
4. Power on/off	25
5. Menu	26
6. Image View	26
7. Temperature Mark	27
8. HI/LO Alert	27
9. LED light	28
10. Palette	28
11. Language	29
12. Temperature Unit	29
13. Emissivity	30
14. Laser	30
15. Time & Date	31
16. Brightness	31
17. Auto Power Off	32
18. Auto Save	32
19. Format SD	33
20. Device Info	33
21. Factory Reset	34
22. USB Communication and PC Analysis Software	34
23. Maintenance	34
24. Safety Instructions	35
25. Appendix	35

1. Specifications

Sensor	Uncooled infrared focal plane thermal imaging sensor
Pixel size	17 μ m
Infrared spectrum bandwidth	8~14 μ m
Thermal imaging pixels	10800 (120*90)
Thermal imaging sensitivity	<60mK
Field of view (FOV)	50°(H) x 38°(V)
Spatial resolution (IFOV)	7.6 mrad
Rate	≤25Hz
Minimum imaging distance	0.1m
Focus	Focus-free
Temperature range	-20°C ~ 400°C
Accuracy	±2°C or ±2% , whichever is greater (-10°C ~ 400°C room temperature 25°C)
Measurement units	°C/°F
Resolution	0.1°C
Emissivity	0.95 (default) 0.01 ~ 0.99
Temperature display	Center point temperature, high/low temperature tracking
Palettes	lava , rainbow HC , black hot , white hot, iron, Rainbow
Display type	2.4" TFT LCD
Display resolution	320 x 240

Buttons	4 buttons (power, up, down, OK) 1 trigger
Laser	√(Class 2)
LED Light	√
Temperature alarms	LCD, LED, buzzer
Image storage	Micro SD Card
Image format	BMP
PC analysis software	√
USB communication	Type-C USB
Battery	Li-ion 3.7V/2600mAh 18650
Operating time	Continuous operating time >9h
Charging time	≤2.5h
Charging voltage/current	5V / 2A
Power on speed	0s (wake up) / 5s (power on)
Auto power off	5min/10min/30min(default)/off
Operating temperature	0 ~ 50°C (32 ~ 140°F)
Storage temperature	-20 ~ 60°C (-4 ~ 140°F)
Operating humidity	< 85%RH (Operating humidity)
IP rating	IP54
Drop proof	2m
Product size (L×W×H)	197 x 72 x 60 mm
Product weight	310g
Certificates	CE 、 UKCA、 RoHS
Accessories	User manual, Type-C USB cable, 16GB Micro SD card

2. Structure

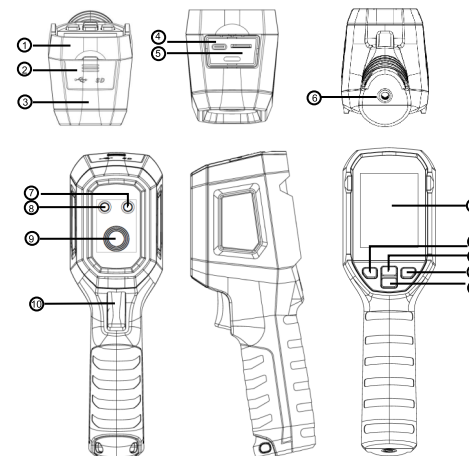

Item	Description	Item	Description
1	Upper housing	9	Infrared camera lens
2	Interface protection cover	10	Image capture/trigger
3	Lower housing	11	LCD
4	USB Type-C interface	12	OK
5	SD card slot	13	Up
6	Bracket screw hole	14	Power
7	Laser emission aperture	15	Down
8	LED light		

3. LCD Indicators/Icons

Display size: 2.4" (495mm×377mm)

Display resolution: 320 (vertical) × 240 (horizontal)

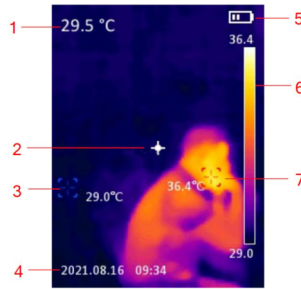

Item	Description
1	Center point temperature
2	Center point
3	Lowest temperature spot
4	Date and time
5	Battery status
6	Temperature Bar
7	Highest temperature spot

4. Power On/Off

When the thermal imager is not turned on, long press the power button for 3s to power on. When the thermal imager is in the suspend state, short press the power button for 1s to power on.

When the thermal imager is turned on, short press the power button for 1s to enter the suspend state. Long press the power button for 8s, "power off" will show on the screen, and the thermal imager will be turned off.

5. Menu

In the main interface, short press the OK button to open the menu. The options are as follows:

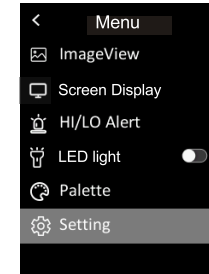

6. Image View

In the menu, select Image View, and then short press the OK button to enter the image viewing interface. Press the Up/Down button to select an image. Press the OK button twice to view the Picture Info or Delete images.

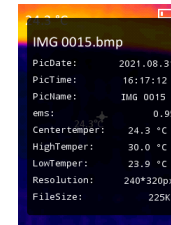
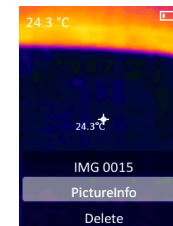
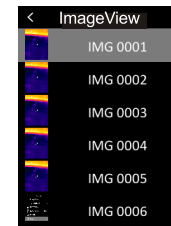

7. Temperature Mark

In the menu, short press the Up/Down button to select Temper Mark, and then short press the OK button to enter the temperature mark interface. Center Point/Hi/Lo Point/Palette/Date&Time can be set in this interface. For example, select Center Point, and then press the OK button to turn on/off this function.

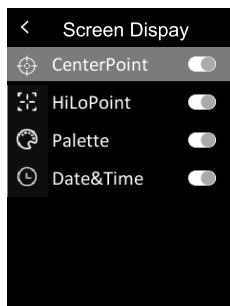

8. HI/LO Alert

In the menu, short press the Up/Down button to select HI/LO Alert, and then short press the OK button to enter the alert setting interface. Temper Alert, Buzzer, HI Alert and LO Alert can be set in this interface.

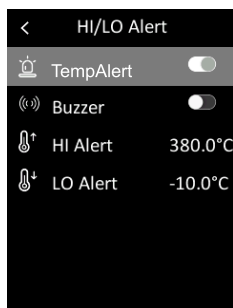

9. LED light

In the menu, short press the Up/Down button to select Hand Light, and then short press the OK button to turn on/off the flashlight.

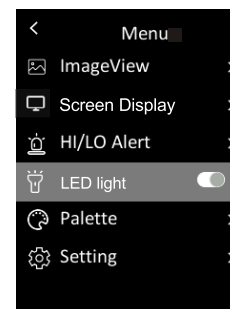

10. Palette

In the menu, short press the Up/Down button to select Palette, and then short press the OK button to enter the palette selection interface. Short press the Up/Down button to step through six palettes: Rainbow, Iron, White Hot, Black Hot, Rainbow HC, Lava, and short press the OK button to confirm the selected palette.

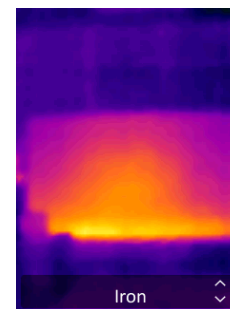

11. Language

In the menu, short press the Up/Down button to select Setting, and then short press the OK button to enter the submenu. Select Language, and short press the OK button to switch between English/Chinese.

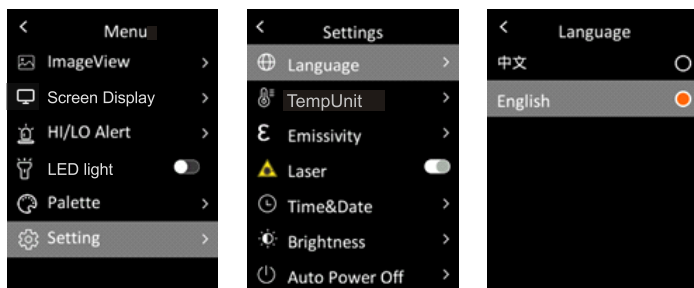

12. Temperature Unit

In the menu, short press the Up/Down button to select Setting, and then short press the OK button to enter the submenu. In the submenu, short press the Up/Down button to select Temper Unit, and short press the OK button to switch between °C/°F.

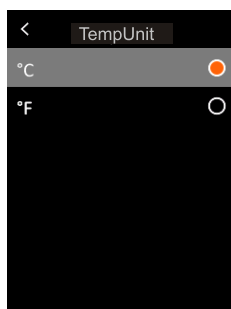

13. Emissivity

In the menu, short press the Up/Down button to select Setting, and then short press the OK button to enter the submenu. In the submenu, short press the Up/Down button to select Emissivity, and short press the OK button to set the emissivity.

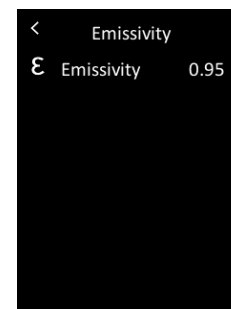

14. Laser

In the menu, short press the Up/Down button to select Setting, and then short press the OK button to enter the submenu. In the submenu, short press the Up/Down button to select Laser, and short press the OK button to turn on/off the laser.

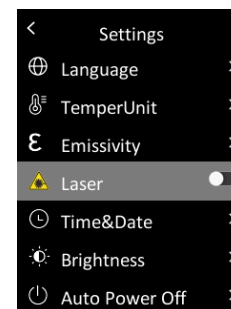

15. Time & Date

In the menu, short press the Up/Down button to select Setting, and then short press the OK button to enter the submenu. In the submenu, short press the Up/Down button to select Time&Date, and short press the OK button to enter the setting interface. The Time Format can switch between 12H and 24H. Press the Up/Down button to adjust the value of time and date, and short press the OK button to confirm. Short press the Power button to return to the previous menu after setting.

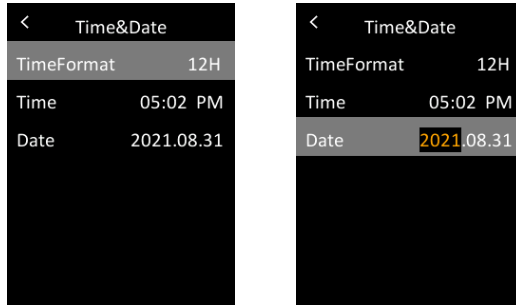

16. Brightness

In the menu, short press the Up/Down button to select Setting, and then short press the OK button to enter the submenu. In the submenu, short press the Up/Down button to select Brightness, and short press the OK button to enter the setting interface. The brightness can be Low, Middle or High.

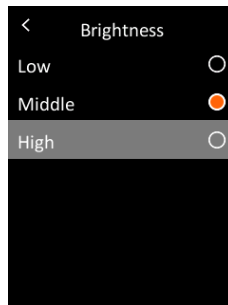

17. Auto Power Off

In the menu, short press the Up/Down button to select Setting, and then short press the OK button to enter the submenu. In the submenu, short press the Up/Down button to select Auto Power Off, and short press the OK button to enter the setting interface. In this interface, users can set the auto power off time (5/10/30min) or turn off the auto power off function.

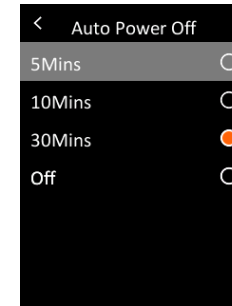

18. Auto Save

In the menu, short press the Up/Down button to select Setting, and then short press the OK button to enter the submenu. In the submenu, short press the Up/Down button to select Auto Save. Short press the OK button to turn on/off the auto save function.

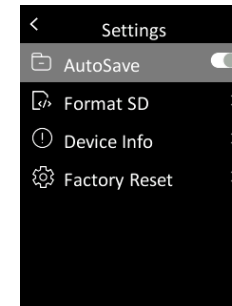

19. Format SD

In the menu, short press the Up/Down button to select Setting, and then short press the OK button to enter the submenu. In the submenu, short press the Up/Down button to select Format SD and short press the OK button to enter the setting interface. Press the OK button select Yes or No.

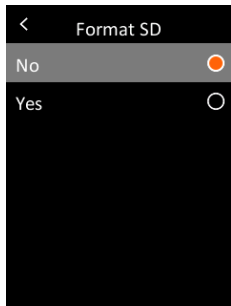

20. Device Info

In the menu, short press the Up/Down button to select Setting, and then short press the OK button to enter the submenu. In the submenu, short press the Up/Down button to select Device Info and short press the OK button to enter the information viewing interface. The device information including Code, Firmware, Capacity and Available can be viewed.

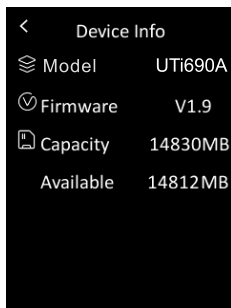

21. Factory Reset

In the menu, short press the Up/Down button to select Setting, and then short press the OK button to enter the submenu. In the submenu, short press the Up/Down button to select Factory Reset and short press the OK button to enter the setting interface. Press the OK button select Yes or No.

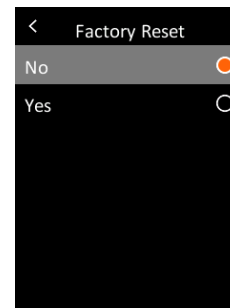

22. USB Communication and PC Analysis Software

1. Please refer to the instructions to download and install the PC software.
2. Connect the USB data cable to the computer. Users can view images and analyze data via the PC software.
3. To use the PC software correctly, please read the Software User Manual.
4. During USB communication, do not directly unplug the USB cable. If users want to disconnect the device when it has been successfully connected to the computer, they can select Remove Device in the lower right corner of the computer.

23. Maintenance

Use a wet cloth or weak soap solution to clean the outer shell of the device. Do not use abrasives, isopropyl alcohol or solvents to clean the outer shell, lens or window.

24. Safety Instructions

In order to ensure the measurement accuracy, please read the instructions carefully. Please use this product in accordance with the user manual. Otherwise the free warranty will not be carried out if the product is damaged. Please do not use this product in flammable, explosive, steamy, humid or corrosive environments. Please do not continue to use the product when it is damaged, dropped or corrected, so as to avoid erroneous measurement results. Please refer to the emissivity to get the actual temperature. Otherwise the measured temperature will be inaccurate. Charging will cause the internal temperature of the machine to rise, thereby affecting the measurement accuracy. Therefore, it is recommended not to take measurements when charging the product.

25. Appendix

Material	Emissivity	Material	Emissivity
Wood	0.85	Black paper	0.86
Water	0.96	Polycarbonate	0.8
Brick	0.75	Concrete	0.97
Stainless steel	0.14	Copper oxide	0.78
Adhesive tape	0.96	Cast iron	0.81
Aluminum plate	0.09	Rust	0.8
Copper plate	0.06	Gypsum	0.75
Black aluminum	0.95	Paint	0.9
Human skin	0.98	Rubber	0.95
Asphalt	0.96	Soil	0.93
PVC plastic	0.93		

UNI-T®

UNI-TREND TECHNOLOGY (CHINA) CO., LTD.

No. 6, Gong Ye Bei 1st Road,
Songshan Lake National High-Tech Industrial
Development Zone, Dongguan City,
Guangdong Province, China

