

**HDG3000B(C) Series
Functions and Arbitrary Waveform
Generator**

User Manual

(V1.0.1)

Content

Copyright Declaration	1
Summary of general safety matters.....	2
General Safety Summary	2
Safety Terms and Symbols.....	3
Product Scrapping	3
Brief Introduction.....	4
Chapter 1 Quick Start	6
1.1 General Inspection	7
1.2 Front Panel	7
1.3 Rear Panel.....	9
1.4 Prepare Instrument for Use	11
1.5 The User Interface.....	12
1.6 Parameter Setting Method	13
1.6.1 Numeric Keypad.....	13
1.6.2 Direction Keys and Knob	13
1.7 Help	14
Chapter 2 Basic Waveform Output.....	15
2.1 Select the Channel	16
2.2 Set the Parameter	16
2.2.1 Select the Basic Waveform	16
2.2.2 Set the Frequency.....	16
2.2.3 Set the Amplitude	17
2.2.4 Set the DC Offset Voltage	17
2.2.5 Set the Start Phase	18
2.2.6 Set the Duty Cycle	19
2.2.7 Set the Symmetry.....	19
2.2.8 Set the Pulse Parameters	20
2.2.9 Enable the Channel Output.....	21
2.3 Basic Waveform Output Example	22
Chapter 3 Arbitrary Waveform Output	24
3.1 Enable Arbitrary Waveform	25
3.2 Select Arbitrary Waveform.....	25
Chapter 4 Harmonic Output.....	30
4.1 Overview.....	31
4.2 Set the Basic Waveform Parameters	31
4.3 Set the Harmonic Order	31
4.4 Set the Harmonic Type.....	32
4.5 Set the Harmonic Amplitude.....	32
4.6 Set the Harmonic Phase	32
Chapter 5 Modulation	33
5.1 AM Modulation.....	34

5.1.1 Select AM Modulation	34
5.1.2 Carrier Waveform Shape	34
5.1.3 Carrier Waveform Frequency.....	34
5.1.4 Modulation Source	34
5.1.5 Modulation Frequency	35
5.1.6 Modulation Depth	35
5.2 DSB-AM Modulation.....	35
5.2.1 Select DSB-AM Modulation	36
5.2.2 Carrier Waveform Shape	36
5.2.3 Carrier Waveform Frequency.....	36
5.2.4 Modulation Source	36
5.2.5 Modulation Frequency	37
5.2.6 Modulation Depth	37
5.3 FM Modulation.....	37
5.3.1 Select FM Modulation	38
5.3.2 Carrier Waveform Shape	38
5.3.3 Carrier Waveform Frequency.....	38
5.3.4 Modulation Source	38
5.3.5 Modulation Frequency	39
5.3.6 Frequency Deviation	39
5.4 PM Modulation.....	39
5.4.1 Select PM Modulation	40
5.4.2 Carrier Waveform Shape	40
5.4.3 Carrier Waveform Frequency.....	40
5.4.4 Modulation Source	40
5.4.5 Modulation Frequency	41
5.4.6 Phase Deviation	41
5.5 ASK Modulation	41
5.5.1 Select ASK modulation	41
5.5.2 Carrier Waveform Shape	42
5.5.3 Carrier Waveform Amplitude.....	42
5.5.4 Modulation Source	42
5.5.5 ASK Rate.....	42
5.5.6 Modulation Amplitude.....	43
5.6 FSK Modulation	43
5.6.1 Select FSK Modulation	43
5.6.2 Carrier Waveform Shape	43
5.6.3 Carrier Waveform Frequency.....	43
5.6.4 Modulation Source	43
5.6.5 FSK Rate.....	44
5.6.6 Hopping Frequency.....	44
5.7 PSK Modulation.....	44
5.7.1 Select PSK Modulation	44
5.7.2 Carrier Waveform Shape	45

5.7.3 Carrier Waveform Phase.....	45
5.7.4 Modulation Source	45
5.7.5 PSK Rate.....	45
5.7.6 Modulation Phase	45
5.8 BPSK Modulation	46
5.8.1 Select BPSK Modulation.....	46
5.8.2 Carrier Waveform Shape	46
5.8.3 Carrier Waveform Phase.....	46
5.8.4 Modulation Source	46
5.8.5 BPSK Rate	46
5.8.6 Modulation Phase	47
5.9 QPSK Modulation.....	47
5.9.1 Select QPSK Modulation	47
5.9.2 Carrier Waveform Shape	47
5.9.3 Carrier Waveform Phase.....	47
5.9.4 Modulation Source	47
5.9.5 QPSK Rate.....	48
5.9.6 Modulation Phase	48
5.10 3FSK Modulation.....	48
5.10.1 Select 3FSK Modulation	48
5.10.2 Carrier Waveform Shape	48
5.10.3 Carrier Waveform Frequency.....	48
5.10.4 Modulation Source	49
5.10.5 3FSK Rate.....	49
5.10.6 Hopping Frequency.....	49
5.11 4FSK Modulation	49
5.11.1 Select 4FSK Modulation.....	49
5.11.2 Carrier Waveform Shape.....	49
5.11.3 Carrier Waveform Frequency.....	50
5.11.4 Modulation Source	50
5.11.5 4FSK Rate	50
5.11.6 Hopping Frequency.....	50
5.12 OSK Modulation	50
5.12.1 Select OSK Modulation.....	51
5.12.2 Carrier Waveform Shape	51
5.12.3 Carrier Waveform Frequency.....	51
5.12.4 Modulation Source	51
5.12.5 OSK Rate	52
5.12.6 Oscillate Time.....	52
5.13 PWM Modulation	52
5.13.1 Select PWM Modulation.....	52
5.13.2 Carrier Waveform Shape	52
5.13.3 Carrier Waveform Duty	53
5.13.4 Modulation Source	53

5.13.5 Modulation Frequency	53
5.13.6 Duty Deviation.....	54
Chapter 6 Sweep	55
6.1 Select Sweep.....	56
6.2 Start Frequency and Stop Frequency.....	56
6.3 Center Frequency and Frequency Span	56
6.4 Linear Sweep.....	57
6.5 Sweep Time	57
6.6 Return Time	57
6.7 Hold Time	58
6.8 Mark Frequency.....	58
6.9 Sweep Trigger Source.....	58
6.10 Trigger Output Edge	58
Chapter 7 Burst.....	60
7.1 Select Burst	61
7.2 Burst Type.....	61
7.3 Burst Count.....	63
7.4 Burst Period.....	63
7.5 Burst Phase	63
7.6 Trigger Source	63
7.7 Gate Polarity.....	64
7.8 Trigger Output Edge	64
Chapter 8 Counter	65
Chapter 9 Store.....	66
9.1 Store System	66
9.2 File Operation	66
Chapter 10 Utility	69
10.1 Sync.....	70
10.2 Impedance Settings.....	71
10.3 System Settings.....	72
10.3.1 Language	72
10.3.2 Clock Source.....	72
10.3.3 Power On Settings	73
10.3.4 Intensity	73
10.3.5 System Information	73
10.3.6 Unit.....	73
10.3.7 Save Picture.....	73
10.4 Firmware Update	74
Chapter 11 Remote Control	75
11.1 Install Keysight IO libraries suite	76
11.2 Remote Control via USB	80
Appendix A Specifications.....	82
Appendix B Accessories	89

Copyright Declaration

All rights reserved; no part of this document may be reproduced or transmitted in any form or by any means, electronic or mechanical, without prior written permission from Hantek Technologies Co., Ltd (hereinafter referred to as 'Hantek').

Hantek reserves all rights to modify this document without prior notice. Please contact Hantek for the latest version of this document before placing an order.

Hantek has made every effort to ensure the accuracy of this document but does not guarantee the absence of errors. Moreover, Hantek assumes no responsibility in obtaining permission and authorization of any third-party patent, copyright or product involved in relation to the use of this document.

Summary of general safety matters

General Safety Summary

Read the following safety precautions to avoid injury and prevent damage to this product or any products connected to it. To evade potential hazards, use this product only as specified.

Only qualified personnel should perform maintenance.

Avoid fire or personal injury.

Use suitable power cord. Use only the power cord specified for this product and certified for the country of use.

Connect and disconnect properly. Connect a probe with the oscilloscope before it is connected to measured circuits; disconnect the probe from the oscilloscope after it is disconnected from measured circuits.

Ground the product. This product is grounded through the grounding conductor of the power cord. To avoid electric shock, the grounding conductor must be connected to earth ground. Before making connections to the input or output terminals of the product, ensure that the product is properly grounded.

Connect the probe in a right way. The probe ground lead is at ground potential. Do not connect the ground lead to an elevated voltage.

Check all terminal ratings. To avoid fire or shock hazard, check all ratings and markings on the product. Refer to the product manual for detailed information about ratings before making connections to the product.

Do not operate without covers. Do not operate this product with covers or panels removed. Avoid exposed circuitry. Do not touch exposed connections and components when power is present.

Do not operate with suspected failures. If you suspect there is damage to this product, have it inspected by qualified service personnel.

Assure good ventilation.

Do not operate in wet/damp environments.

Do not operate in an explosive atmosphere.

Keep product surfaces clean and dry.

Safety Terms and Symbols

Terms on the product. The following terms may appear on the product:

Danger It represents that harms may be caused to you at once if you perform the operation.

Warning It represents that latent harms may be caused to you if you perform the operation.

Notice It represents the damage possibly caused to the product or other properties if you perform the operation.

Characters on the product. The following characters may appear on the product:



Notice
Please read
the manual



Protective
ground terminal



Measuring
ground terminal



Chassis
ground terminal

Product Scrapping

Device Recycling

We need extract and utilize natural resources to produce this device. If you do not reclaim the device in a proper way, some substances it contains may become harmful or poisonous to environments or human bodies. To avoid them being released outside and to minimize the waste of natural resources, we suggest you reasonably call back this device to ensure proper recovery and recycling of most materials within it.

Brief Introduction

HDG3000 series waveform generator is an economical, high performance, multi-functional dual channel function/arbitrary waveform generator that does integrates functions of function generator, arbitrary waveform generator, pulse generator, harmonic generator, analog/digital modulator, counter, etc.

Features:

- ◆ The six maximum output frequencies are 100MHz, 80MHz, 60MHz, 40MHz, 25MHz and 15MHz.
- ◆ 16-bit vertical resolution, 300MSa/s sampling rate for CH1 and CH2.
- ◆ 2 Mpts Max. arbitrary waveform Memory Depth.
- ◆ Precisely adjust the phases of the two channels
- ◆ 160 waveforms or functions: Sine, Square, Ramp, Pulse, Noise, Exponential Rise, Exponential Fall, ECG, Gauss, Haversine, Lorentz, Dual Tones, Harmonics, Video Signal, Radar Signal, DC etc.
- ◆ Rise Time and Fall Time of the Pulse could be adjusted separately
- ◆ Enable to output harmonic with specified order and amplitude, enable to output up to 16th order of harmonic.
- ◆ Various modulation types: AM, DSB-AM, FM, PM, ASK, FSK, PSK, BPSK, QPSK, 3FSK, 4FSK, OSK and PWM modulations.
- ◆ Support frequency sweep and Burst output
- ◆ Dual channels can perform internal /external /another channel modulation and internal/external/manual trigger separately or at the same time.
- ◆ Dual channels can output sync signal separately or at the same time
- ◆ Provide 80MHz Counter; enable to measure various parameters of external signal such as frequency, period, duty cycle, positive pulse width and negative pulse width.
- ◆ Support waveform copy and state copy between channels.
- ◆ Enable store and read instrument state file, and enable read arbitrary waveform data file from external storage device.
- ◆ Standard configuration interface: Front USB Host and RearUSB Device.
- ◆ Abundant I/O: waveform output, sync signal output, modulation input, 10MHz clock input/output and trigger input/output.
- ◆ Support FAT32 formatted USB storage device (flash type) storage
- ◆ Provide Chinese and English help information, prompt message and interface display.
- ◆ Equipped with powerful waveform editing PC software
- ◆ Compatible with SCPI (Standard Command for Programmable Instruments).
- ◆ 4.3-inch color TFT LCD screen.

Model

Model	Channels	Max.Frequency	CH1/CH2 Sampling Rate	CH3 Sampling Rate
HDG3012B	2	15MHz	300MS/s	-
HDG3022B	2	25MHz	300MS/s	-
HDG3042B	2	40MHz	300MS/s	-
HDG3062B	2	60MHz	300MS/s	-
HDG3082B	2	80MHz	300MS/s	-
HDG3102B	2	100MHz	300MS/s	-
HDG3013C	3	15MHz	300MS/s	150MSa/s
HDG3023C	3	25MHz	300MS/s	150MSa/s
HDG3043C	3	40MHz	300MS/s	150MSa/s
HDG3063C	3	60MHz	300MS/s	150MSa/s
HDG3083C	3	80MHz	300MS/s	150MSa/s
HDG3083C	3	100MHz	300MS/s	150MSa/s

Format Conventions in this Manual

Keys

The keys on the front panel are usually denoted by the format of "Key Name (Bold) + Square Brackets (Bold)". For example, **[Utility]**.

Chapter 1 Quick Start

This chapter introduces the front panel, rear panel, user interface and parameter setting method as well as precautions when using the instrument for the first time.

- ◆ **General Inspection**
- ◆ **Front Panel**
- ◆ **Rear Panel**
- ◆ **Prepare Instrument for Use**
- ◆ **The User Interface**
- ◆ **Parameter Setting Method**
- ◆ **Help**

1.1 General Inspection

Please check the instrument as following steps after receiving an oscilloscope:

Check the shipping container for damage:

Keep the damaged shipping container or cushioning material until the contents of the shipment have been checked for completeness and the instrument has been checked mechanically and electrically.

Check the accessories:

Accessories supplied with the instrument are listed in "Accessories" in this manual. If the contents are incomplete or damaged, please notify the franchiser.

Check the instrument:

In case there is any mechanical damage or defect, or the instrument does not operate properly or fails performance tests, please notify the franchiser.

1.2 Front Panel

The content below simply describes and introduces the front panel of HDG3000B(C) so that you can get familiar with it well within the shortest time.



1. On/Off Switch

2. Menu Softkey

Correspond to the left menus respectively. Press any softkey to activate the corresponding menu.

3. Function Keys

Wave: Select the waveform that the current channel will output.

Setting: Set the parameters of the waveform that the current channel will output.

Utility: Auxiliary functions and system Settings. Used to set auxiliary function and system

parameters.

Mod: Enable generate modulated waveforms. A variety of analog and digital modulation methods are provided to generate AM, DSB-AM, FM, PM, ASK, FSK, PSK, BPSK, QPSK, 3FSK, 4FSK, OSK and PWM modulation signals.

Sweep: Enable generate sweep signals of "sine", "square", "ramp", "pulse", "harmonic" and "arbitrary (except DC)".

Burst: Enable generate burst signals of "sine", "square", "ramp", "pulse", "harmonic" and "arbitrary (except DC)".

Trigger: Manually triggered button. In sweep or burst mode, used to manually trigger CH1 or CH2 to produce a sweep or burst signal (only when **1Output** or **2Output** is turned on).

CH1/2/3 or CH1/2: Channel switching. Press this button to switch menu setting channel.

After selecting CH1, users can set the waveforms, parameters, and configuration of CH1.

After selecting CH2, users can set the waveforms, parameters, and configuration of CH2.

After selecting CH3, users can set the waveform, parameters, and configuration of CH3. Only HDG3000C supports CH3 output.

4. CH1/CH2 Output Connector

BNC connector with 50Ω nominal output impedance.

When **1Output** or **2Output** is enabled (the backlight turns on), this connector output waveform according to the current configuration of the channel.

5. Channel ON/OFF: Enable or disable the output of CH1 or CH2.

6. Direction Keys

When using the knob and direction keys to set parameters, the direction keys are used to switch the digits of the parameter.

During file name input, they are used to move the cursor.

7. Knob

During parameter setting, it is used to increase (clockwise) or decrease (counterclockwise) the current highlighted number. It is used to select file storage location or select the file to be recalled when storing or recalling file. It is used to switch the character in the soft keyboard when entering filename.

8. Numeric Keypad

It is used to input parameters and consists of numbers (0 to 9), decimal point (.), operators (+/-). Note that if a negative is required, please input an operator "-" before the numbers. (For the use method of the numeric keypad, refer to the introduction in "[Parameter Setting Method](#)").

9. LCD

4.3-inch color TFT LCD screen, display the current function menu and parameter settings, system states as well as prompt messages.

10. Default

It is used to restore the instrument state to the factory default settings.

11. Help

To get the context help information about any front-panel key or menu softkey, press this key

and then press the button you need to get the help information for.

12. USB HOST Interface

External storage device (USB disk) can be accessed for saving or loading settings files. The file system format of the external storage device is FAT32 and the memory is no more than 32G.

1.3 Rear Panel



1. CH1/CH2 Sync/ExtMod/TrigConnector

BNC connector with 50Ω nominal output impedance and 1KΩ nominal input impedance. Its function is determined by the current working mode.

➤ **Sync:**

When **1Output** is enabled, this connector outputs the sync signal corresponding to the current settings of CH1 (refer to the introduction in [Sync](#)).

➤ **ExtMod:**

If modulation mode is enabled for CH1, and external modulation source is used, this connector accepts an external modulation signal.

➤ **Trig:**

If CH1 is in sweep or burst mode and external trigger source is used, this connector accepts an external trigger signal (the polarity of the signal can be set).

2. CH3 SYNC Output Connector

BNC connector with 50Ω nominal output impedance.

When CH3 output is turned on, the connector outputs the sync signal corresponding to the current settings of CH3 (refer to the introduction in [Sync](#)).

3. CH3 Output Connector

BNC connector with 50Ω nominal output impedance.

When CH3 output is turned on (press **[CH1/2/3]** to select the CH3 window display, then press **CH3** softkey and switch to "ON"), the corresponding connector outputs the configured waveform.

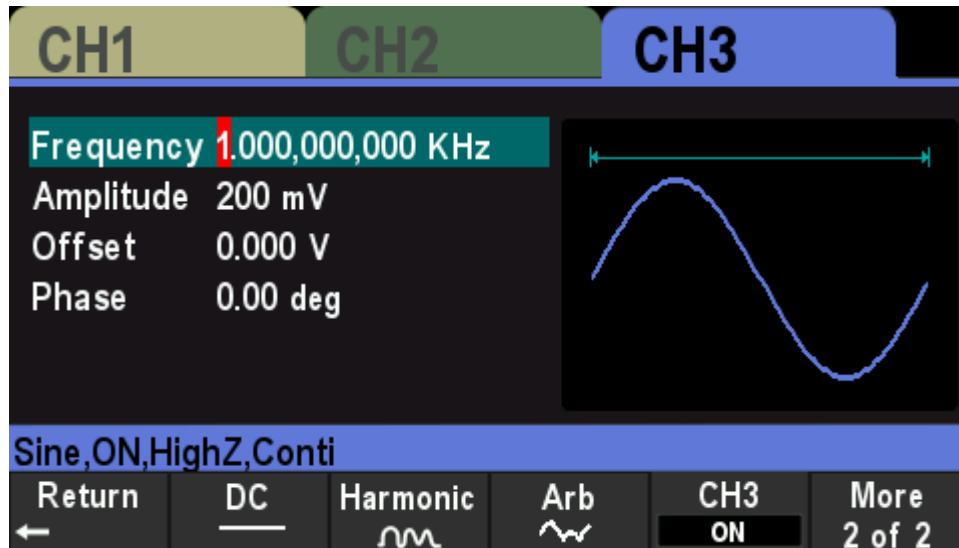

4. 10 MHz Reference In/Out (10MHz In/Out)

BNC connector with 50Ω nominal output impedance and 5KΩ nominal input impedance. The function of this connector is determined by the type of clock used by the generator.

HDG3000B(C) can use internal or external clock (refer to the introduction in "[Clock Source](#)").

- When internal clock source is used, the connector (used as 10MHz Out) can output 10MHz clock signal generated by the internal crystal oscillator of the generator.
- When external clock source is used, the connector (used as 10MHz In) accepts a 10MHz external clock signal.
- This connector is usually used to synchronize multiple instruments (refer to the introduction in "[Clock Source](#)").

5. Counter (0~3.3V, external signal input)

BNC connector with 500Ω nominal input impedance. It is used to accept an external signal to be measured by the counter.

6. USB DEVICE Interface

7. Safety Lock Hole

8. AC Power Socket

1.4 Prepare Instrument for Use

Adjust the Handle

To adjust the handle of the instrument, hold both sides of the handle and pull them outward, then rotate the handle.

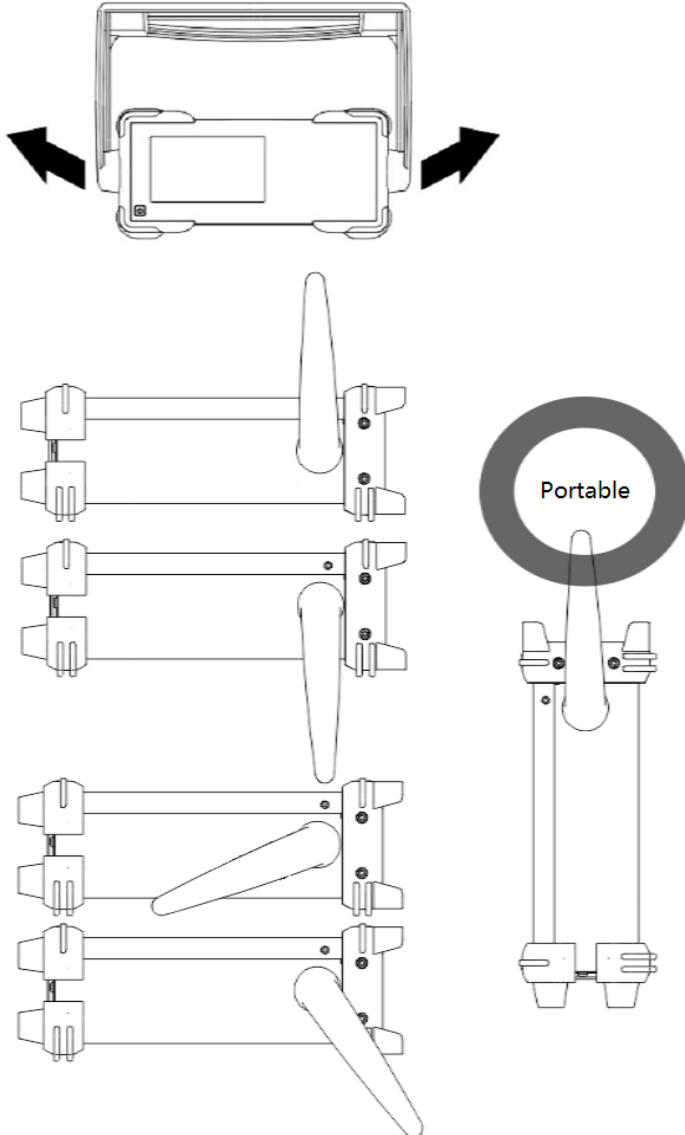

Connect to AC power cord

Connect the power cord as required.

This instrument can accept the power supply of 100-120VAC ($\pm 10\%$), 45-440 Hz or 120-240VAC ($\pm 10\%$), 45-66Hz. Please use the power cord supplied with the accessories to connect the instrument to the power supply.

Press the power switch on the front panel to turn on the instrument. If the instrument is not turned on, make sure that the power cord is securely connected. Also make sure that the instrument is connected to an energized power source.

Power Switch:



To turn off the instrument, press the power switch.

1.5 The User Interface

The user interface is shown in the following figure.



1. **Displays the selected channel.** Only HDG3000C supports CH3 output.

2. Channel Parameters

Display the waveform parameters of the current channel.

Press the parameter softkey and use the numeric keypad or direction keys and knob to modify the value. The parameters that can be modified will be highlighted, and the red background of the number indicates the current cursor position.

3. Waveform

Display the selected waveform type of the current channel.

4. Channel Configuration

Displays the output configuration of the current channel, including waveform type, output impedance, operating mode and output state.

Output Impedance: HighZ (High Impedance) or 50Ω.

Mode: Modulation, Sweep, Burst or Continuous output.

5. Menu

Displays the operation menu corresponding to the currently selected function. For example, the function menu of the "Wave" button is displayed in the figure.

1.6 Parameter Setting Method

Users can use the numeric keypad or knob and direction keys to set parameters.

1.6.1 Numeric Keypad

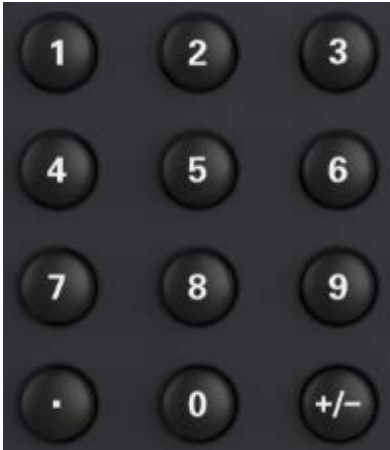

The numeric keypad consists of the following parts:

Number keys

The 0 to 9 number keys are used to directly input the desired parameter value.

Decimal point

Press this key to insert a decimal point "." at the current position of the cursor.

Operator Key

The operator key "+/-" is used to modify the operator of the parameter. Press this key to set the parameter operator to "-".

1.6.2 DirectionKeys and Knob



Functions of the direction keys:

- ◆ During parameter input, use the direction keys to move the cursor to select the digit to be

edited.

- ◆ During filename edit, use the direction keys to move the cursor.

Functions of the knob:

- ◆ When the parameter is in editable state, turn the knob to increase (clockwise) or reduce (counterclockwise) the parameter with specified step.
- ◆ During filename edit, use the knob to select the characters in the soft keyboard.
- ◆ In **[Wave] >Arb >Type >User**, use the knob to select arbitrary waveform.
- ◆ In store and recall, use the knob to select the storage location of the file or to select the file to be recalled.

1.7 Help

To get help information for any front panel keys or menu softkeys, press **Help** button on the front panel, and then press the button or softkey you need to get help information for.

If there are indexes for other topics in the content view, users can rotate the knob to choose a different index and press the knob to enter the corresponding topic content.

Press **Help** button again to exit.

Help Button:

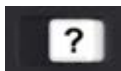

Chapter 2 Basic Waveform Output

HDG3000B(C) can output basic waveforms (including Sine, Square, Ramp, Pulse and Noise) from one of the channels separately or from the two channels at the same time. At start-up, the channel is configured as a sine waveform with 1KHz frequency and 200mVpp amplitude by default. This chapter introduces how to configure the instrument to output various basic waveforms.

- ◆ **Select the Channel**
- ◆ **Set theParameter**
- ◆ **Basic Waveform Output Example**

2.1 Select the Channel

Users can configure HDG3000B(C) to output basic waveform from a single channel or from dual channels at the same time. Please select the desired channel before configuring waveform parameters. At start-up, CH1 is selected by default.

Press **[CH1/2]** or **[CH1/2/3]** button on the front panel and the corresponding area in the user interface is illuminated. At this point, users can configure the waveform and parameters of the channel selected.

Note: CH1 and CH2 cannot be selected at the same time. Users can first select CH1 and then select CH2 after configuring the waveform and parameters of CH1.

2.2 Set theParameter

2.2.1 Select the BasicWaveform

HDG3000B(C) can output 5 kinds of basic waveforms, including Sine, Square, Ramp, Pulse and Noise. At start-up, Sine is selected by default.

Press **[Wave]** button on the front panel, and then press the corresponding softkey in the menu to select the waveform and enter the parameter setting menu. Now the user interface displays the selected waveform shape.

Press **[Wave] > CH1=CH2** softkey to change the settings of another channel to be the same as the settings of the current channel.

2.2.2 Set the Frequency

Frequency is one of the most important parameters of the basic waveforms. For different models and different waveforms, the setting ranges of the frequency are different. For detailed information, please refer to "Frequency Characteristics" in "[Specifications](#)". The default frequency is 1 KHz. The frequency displayed on the screen is the default value or the frequency previously set. When the instrument function is changed, if this frequency is valid under the new function, the instrument will still use this frequency; otherwise, the instrument would display prompt message and set the frequency to the frequency upper limit of the new function automatically.

Press **[Setting] > Frequency** softkey. At this point, use the numeric keypad to input the value of the frequency and select the desired unit from the pop-up unit menu, or use the direction keys and knob to modify the current value.

1. For the input method of frequency value, please refer to the introduction of "[Parameter Setting Method](#)".
2. The frequency units available are MHz, KHz, Hz and mHz.
3. Press **[Utility] > Unit** softkey and press **Frequency/Period** softkey to switch **Frequency** in the parameter to **Period**. Press **[Setting] > Period** softkey to modify the period parameter.
4. The period units available are sec, msec, μ sec and nsec.

2.2.3 Set the Amplitude

The amplitude range is limited by Frequency or Period and Impedance settings. Please refer to "Output Characteristics" in "[Specifications](#)". The default value is 200mVpp.

The amplitude displayed on the screen is the default value or the amplitude previously set. When the instrument configuration (e.g. frequency) is changed, if this amplitude is valid, the instrument will still use this amplitude; otherwise, the instrument would display a prompt message and set the amplitude to the amplitude upper limit of the new configuration automatically.

Press [**Setting**] > **Amplitude** softkey. At this point, use the numeric keypad to input the value of the amplitude and select the desired unit from the pop-up unit menu, or use the direction keys and knob to modify the current value.

1. For the input method of amplitude value, refer to the introduction in "[Parameter Setting Method](#)".
2. The amplitude units available are Vpp, mVpp, and Vrms, dBm (50Ω impedance).
3. Press [**Utility**] > **Unit** softkey and press **Amplitude/High Level** softkey to switch the **Amplitude** and **Offset** in the parameter to **High Level** and **Low level**. Press [**Setting**] > **High Level** or **Low Level** softkey to modify high level or low level parameters.
4. The high level units available are V and mV.

Tips:

Switch between Vpp and Vrms

Vpp is the unit for the signal peak-peak value and Vrms is the unit for the signal effective value. The default unit of the instrument is Vpp. Users can quickly switch the current amplitude unit from the front panel.

For different waveforms, the relations between Vpp and Vrms are different. Take sine waveform as an example; the relation of the two units is as shown in the figure below.

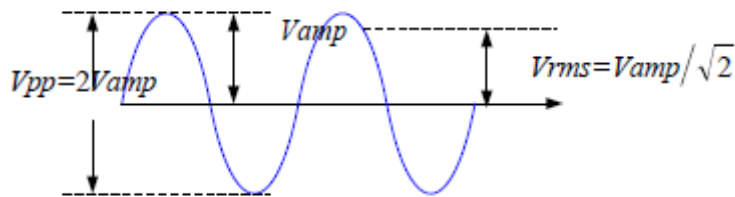

According to the figure above, the conversion relation between Vpp and Vrms fulfills the following equation.

$$V_{pp} = 2\sqrt{2}V_{rms}$$

For example, convert 2Vpp to the corresponding value in Vrms.

For sine waveform, press in the numeric keypad to enter 0.707 and select the Vrms menu.

2.2.4 Set the DC Offset Voltage

The settable range of the DC offset voltage is limited by the Amplitude and Impedance settings. Please refer to the "Output Characteristics" in "[Specifications](#)". The default value is 0VDC.

Press [**Setting**] >**Offset** softkey. At this point, use the numeric keypad to enter the offset value and select the desired unit from the pop-up unit menu, or use the direction keys and knob to modify the current value.

1. For the input method of offset value, refer to the introduction in "[Parameter Setting Method](#)".
2. The DC offset voltage units available are V and mV.
3. Press [**Utility**] >**Unit** softkey and press **Offset/Low Level** softkey to switch **Amplitude** and **Offset** in the parameter to **High** and **Low level**. Press [**Setting**] >**High level** or **Low level** softkey to modify high-level or low-level parameters.
4. The low level units available are V and mV.

2.2.5 Set the Start Phase

Press [**Setting**] >**Phase** softkey to enter the phase submenu. At this point, use the numeric keypad to input the value of the phase and select the unit "Degree" from the unit menu that pops up, or use the direction keys and the knob to modify the current value.

1. For the input method of phase value, refer to the introduction in "[Parameter Setting Method](#)".
2. The starting phase can be set from 0° to 360°. The default value is 0°.
3. Press **0 phase** softkey to quickly set the phase to 0°.
4. Press **SYNC** softkey to synchronize the phase of the two channels (CH1 and CH2) with each other.

For two signals whose frequencies are the same or in multiple, this operation will align their phases. For example, assume a sine waveform (1KHz, 8Vpp, 0°) is output from CH1, while another (1KHz, 8Vpp, 180°) from CH2. Use an oscilloscope to sample and display the waveforms of the two channels. You will see that the phase deviation of the two waveforms displayed on the oscilloscope is not 180°. At this point, press **SYNC** softkey on the generator and the waveforms shown on the oscilloscope will have a phase deviation of 180° without any adjustment of the start phase of the generator.

Before synchronizing phase:

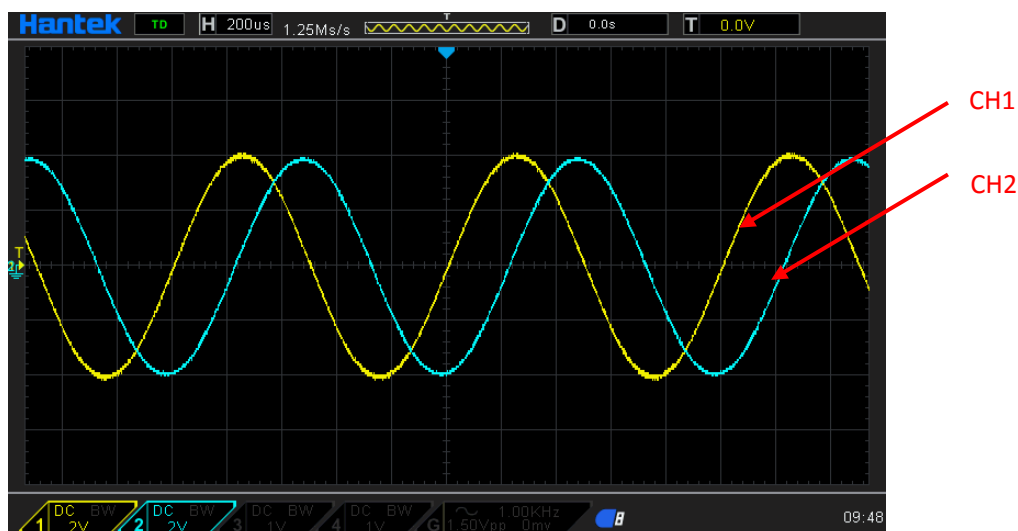

After synchronizing phase:

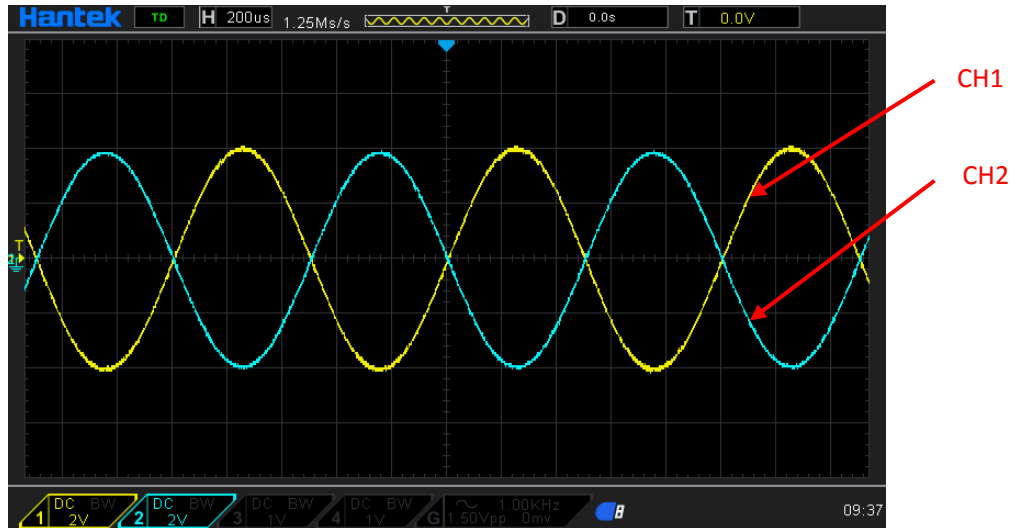

2.2.6 Set the Duty Cycle

Duty cycle is defined as the percentage that the high level takes up in the whole period as shown in the figure below.

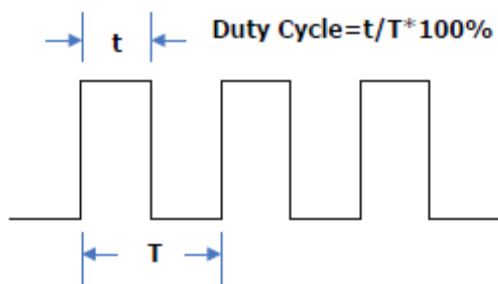

The duty cycle range is limited by the "**Frequency/Period**" setting. Please refer to "Signal Characteristics" in [Specifications](#). The default value is 50%.

Press [**Wave**] > **Squares** softkey to select the square waveform function and press **Duty** softkey to highlight it. At this point, use the numeric keypad to input the value and select the unit "%" from the unit menu that pops up, or use the direction keys and the knob to modify the current value. For the input method of duty cycle value, refer to the introduction in [Parameter Setting Method](#).

2.2.7 Set the Symmetry

Symmetry is defined as the percentage that the rising period takes up in the whole period as shown in the figure below. This parameter is only available when ramp is selected.

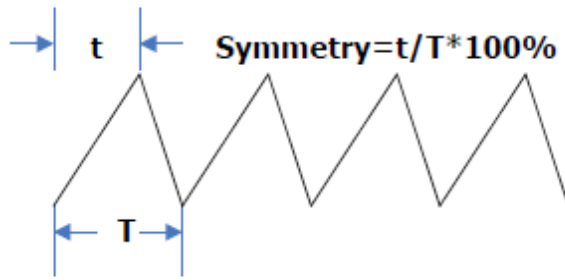

Symmetry can be set in the range of 0% to 100%.The default value is 50%.

Press **[Wave] > Ramp** softkey to select the rampwave function and press **Symmetry** softkey to highlight it. At this point, use the numeric keypad to input the value and select the unit "%" from the unit menu that pops up, or use the direction keys and the knob to modify the current value. For the input method of symmetry value, refer to the introduction in "[Parameter Setting Method](#)".

2.2.8 Set the Pulse Parameters

To output a pulse, users need to set the "Width/Duty", "Leading" and "Trailing", in addition to the basic parameters (such as the frequency, amplitude, DC offset voltage, high level, low level and align phase) introduced above.

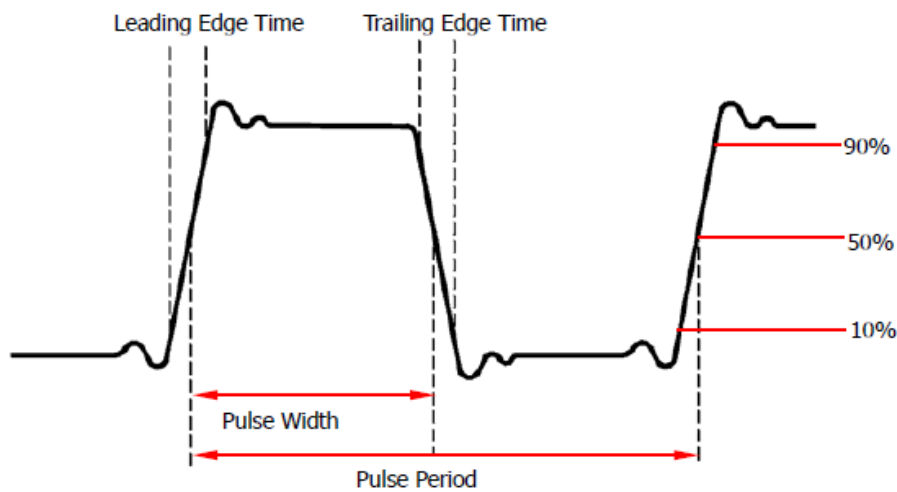

Pulse width/duty cycle

Pulse width is defined as the time from the 50% threshold of a rising edge amplitude to the 50% threshold of the next falling edge amplitude as shown in the figure above.

The settable range of the pulse width is limited by the "Minimum Pulse Width" and the "Pulse Period" (for the ranges of the "Minimum Pulse Width" and "Pulse Period", please refer to "Signal Characteristics" in "[Specifications](#)"). The default value is 100 μ s.

1. Pulse Width Minimum Pulse Width
2. Pulse Width Pulse Period - Minimum Pulse Width

Pulse duty cycle is defined as the percentage that the pulse width takes up in the whole pulse

period.

The pulse width and pulse duty cycle are correlative. Once a parameter is changed, the other will be automatically changed. The pulse duty cycle is limited by the "Minimum Pulse Width" and "Pulse Period".

1. $\text{Duty Cycle} = \frac{\text{Minimum Pulse Width}}{\text{Pulse Period}} \times 100\%$
2. $\text{Minimum Pulse Width} = \text{Pulse Period} \times \text{Duty Cycle} \times 100\%$

Press **[Wave] > Pulse** softkey to select the pulse wave function and press **Width** softkey to highlight it. At this point, use the numeric keypad to input the value and select the desired unit from the unit menu that pops up, or use the direction keys and knob to modify the current value.

1. For the input method of the value, refer to the introduction in "[Parameter Setting Method](#)".
4. The width units available are sec, msec, μ sec and nsec.
3. Press **[Utility] > unit** softkey and press **Width/Duty** softkey to change **Width** in the parameter to **Duty**. Press **[Setting] > Duty** softkey to modify the duty cycle parameters.

Leading/Trailing Edge Time

The leading (rising) edge time is defined as the time required for the pulse amplitude to rise from 10% threshold to 90% threshold; while the trailing (falling) edge time is defined as the time required for the pulse amplitude to fall from 90% threshold to 10% threshold as shown in the figure above.

The range of the leading/trailing edge time is limited by the pulse width currently specified as shown in the formula below. The edge time will be automatically adjusted to match the specified pulse width if the value currently set exceeds the limit value.

$$\text{Leading/Trailing Edge Time} \leq 0.625 \times \text{Pulse Width}$$

Press **[Wave] > Pulse** softkey to select pulse wave function and press **Edge Time** softkey to enter the Edge Time sub-menu. Press **Leading** or **Trailing** softkey to highlight it. At this point, use the numeric keypad to input the value and select the desired unit from the unit menu that pops up, or use the direction keys and knob to modify the current value.

1. For the input method of the value, refer to the introduction in "[Parameter Setting Method](#)".
2. The edge time units available are sec, msec, μ sec and nsec.
3. The leading time and trailing time are independent from each other and users can set them separately.

2.2.9 Enable the Channel Output

After configuring the parameters of the waveform selected, waveform output could be enabled.

Press **[Output1]** or/and **[Output2]** button on the front panel and the backlight of the button turns on. The instrument outputs the configured waveform from the **[Output1]** or **[Output2]** connector on the front panel.

2.3 Basic Waveform Output Example

Configure the generator to output a pulse waveform with 1.5MHz frequency, 500mVpp amplitude, 5mV_{DC} DC offset, 200ns pulse width, 75ns leading edge time and 100ns trailing edge time.

1. Press **[CH1/2/3]** button on the front panel and select CH1. The corresponding area of CH1 in the user interface is illuminated.
2. Press **[Wave] > Pulse** softkey to select the pulse wave function.
3. Press **Frequency** softkey to highlight it. Use the numeric keypad to input the frequency value "1.5", and then select the desired unit "MHz" from the pop-up menu.
4. Press **Amplitude** softkey to highlight it. Use the numeric keypad to input the amplitude value "500", and then select the desired unit "mVpp" in the pop-up menu.
5. Press **Offset** softkey to highlight it. Use the numeric keypad to input the offset value "5", and then select the desired unit "mV" in the pop-up menu.
6. Press **Width** softkey to highlight it. Use the numeric keypad to input the width value "200", then select the unit "nsec" from the menu that pops up.
7. Press **Edge Time** softkey to enter the edge time submenu. Press **Leading** softkey to highlight it. Use the numeric keypad to enter the value "75", then select the unit "nsec" from the menu that pops up.
8. Press **Edge Time** softkey to enter the edge time submenu. Press **Trailing** softkey to highlight it. Use the numeric keypad to enter the value "100", then select the unit "nsec" from the menu that pops up.
9. Press **[Output1]** button on the front panel to turn CH1 Output on.

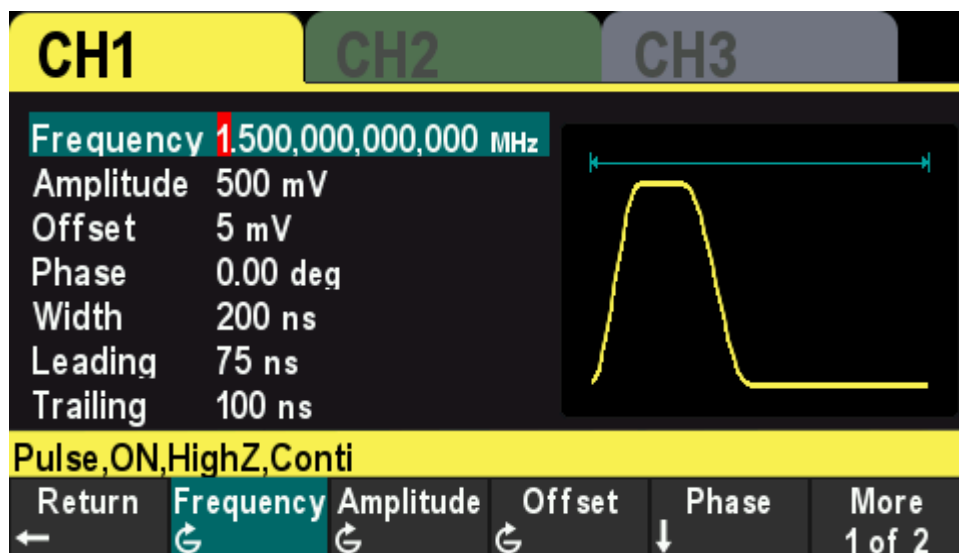

10. At this point, the specified waveform is output from CH1 based on the current configuration. Connect the CH1 output terminal to the oscilloscope and the waveform is as shown in the figure below.

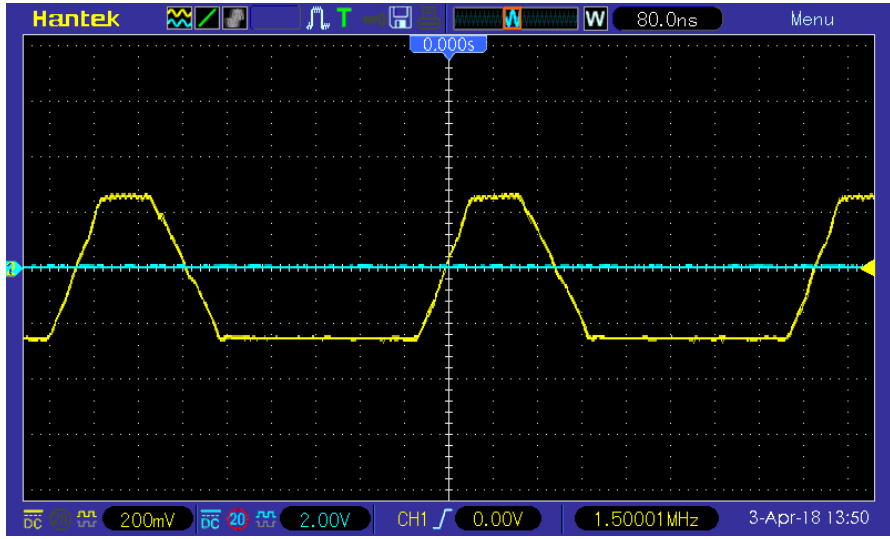

Chapter 3 Arbitrary Waveform Output

HDG3000B(C) can output the built-in waveforms and user-defined arbitrary waveforms from a single channel or from two channels at the same time. The 160 kinds of built-in waveforms are stored in the internal non-volatile memory. The user-defined arbitrary waveforms can contain 64 to 2M data points. Users can edit the arbitrary waveforms via the PC software and then download them to the instrument.

This chapter introduces how to configure the generator to output arbitrary waveforms.

- ◆ **Enable Arbitrary Waveform**
- ◆ **Select Arbitrary Waveform**

3.1 Enable Arbitrary Waveform

Press **[Wave] >Arb** softkey to enable the arbitrary waveform function and open the operation menu of the arbitrary waveform.

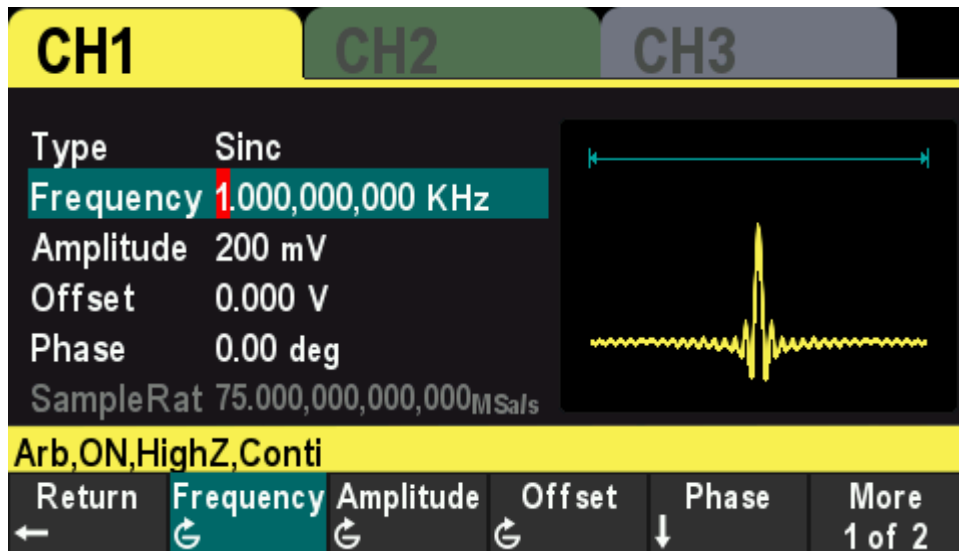

To set the basic parameters of arbitrary waveforms, refer to “Set the Parameters”.

Type: Select the built-in waveforms or user-defined arbitrary waveform stored in external storage.

3.2 Select Arbitrary Waveform

The HDG3000B(C) allows the user to select arbitrary waveform in the internal or external memory of the instrument for output.

Press **[Wave] >Arb>Types** softkey to select the built-in waveform.

Select more than 160 kinds of arbitrary waveform built in HDG3000B(C), as shown in the following table. Press the softkey and select a type ("Math", "Project", "Distribution function" and "Trigonometric function", "Window function" and "biology"), and press the corresponding softkey type to select the desired waveform.

Build-In Waveform

Name	Description
Common	
DC	DC signal
AbsSine	Absolute value of a Sine
AbsSineHalf	Absolute value of half a Sine
AmpALT	Gain oscillation curve
AttALT	Attenuation oscillation curve
GaussPulse	Gauss pulse
NegRamp	Negative ramp
NPulse	Negative pulse
PPulse	Positive pulse
SineTra	Sine-Tra waveform

SineVer	Sine-Ver waveform
StairDn	Stair-down waveform
StairUD	Stair-up and stair-down waveform
StairUp	Stair-up waveform
Trapezia	Trapezoid waveform
Project	
BandLimited	Bandwidth-limited signal
BlaseiWave	Time-velocity curve of explosive vibration
Butterworth	Butterworth filter
Chebyshev1	Chebyshev1 filter
Chebyshev2	Chebyshev2 filter
Combin	Combination function
CPulse	C pulse
CWPulse	CW pulse
DampedOsc	Time-displacement curve of damped oscillation
DualTone	Dual-tone signal
Gamma	Gamma signal
GateVibar	Gate self-oscillation signal
LFMPulse	Linear FM pulse
MCNoise	Mechanical construction noise
Discharge	Discharge curve of Ni-MH battery
Pahcur	Current waveform of DC brushless motor
Quake	Analog quake waveform
Radar	Analog radar waveform
Ripple	Ripple wave of battery
RoundHalf	RoundHalf wave
RoundsPM	RoundsPM waveform
StepResp	Step-response signal
SwingOsc	Kinetic energy- time curve of swing oscillation
TV	TV signal
Voice	Voice signal
Sec-Mod	
AM	Sectioned sine AM signal
FM	Sectioned sine FM signal
PFM	Sectioned pulse FM signal
PM	Sectioned sine PM signal
PWM	Sectioned PWM signal
Bioelect	
Cardiac	Cardiac signal
EOG	Electro-Oculogram
EEG	Electroencephalogram
EMG	Electromyogram
Pulseilogram	Pulsilogram
ResSpeed	Speed curve of the respiration

Medical	
LFPulse	Waveform of the low frequency pulse electrotherapy
Tens1	Waveform 1 of the nerve stimulation electrotherapy
Tens2	Waveform 2 of the nerve stimulation electrotherapy
Tens3	Waveform 3 of the nerve stimulation electrotherapy
Standard	
Ignition	Ignition waveform of the automotive motor
ISO16750-2 SP	Automotive starting profile with ringing
ISO16750-2 VR	Automotive supply voltage profile for resetting
ISO7637-2 TP1	Automotive transients due to disconnects
ISO7637-2 TP2A	Automotive transients due to inductance in wiring
ISO7637-2 TP2B	Automotive transients due ignition switching off
ISO7637-2 TP3A	Automotive transients due to switching
ISO7637-2 TP3B	Automotive transients due to switching
ISO7637-2 TP4	Automotive supply profile during starting
ISO7637-2 TP5A	Automotive transients due to battery disconnect
ISO7637-2 TP5B	Automotive transients due to battery disconnect
SCR	SCR firing profile
Surge	Surge signal
Math	
Airy	Airy function
Besselj	Bessell function
Bessely	Besselll function
Cauchy	Cauchy distribution function
Cubic	Cubic function
Dirichlet	Dirichlet function
Erf	Error function
Erfc	Complementary error function
Erfclnv	Inverted complementary error function
Erflnv	Inverted error function
ExpFall	Exponential fall function
ExpRise	Exponential rise function
Gauss	Gauss distribution
HaverSine	HaverSine function
Laguerre	4-times Laguerre polynomial
Laplace	Laplace distribution
Legend	5-times Legend polynomial
Log	Logarithm function with the base 10
LogNormal	Logarithmic Gaussian distribution
Lorentz	Lorentz function
Maxwell	Maxwell distribution
Rayleigh	Rayleigh distribution
Versiera	Versiera
Weibull	Weibull distribution

ARB_X2	Square function
Trigonome	
CosH	Hyperbolic cosine
CosInt	Integral cosine
Cot	Cotangent
CotHCon	Concave hyperbolic cotangent
CotHPro	Protuberant hyperbolic cotangent
CscCon	Concave cosecant
CscPro	Protuberant cosecant
CscHCon	Concave hyperbolic cosecant
CscHPro	Protuberant hyperbolic cosecant
RecipCon	Concave reciprocal
RecipPro	Protuberant reciprocal
SecCon	Concave secant
SecPro	Protuberant secant
SecH	Hyperbolic secant
Sinc	Sinc function
SinH	Hyperbolic sine
SinInt	Integral sine
Sqrt	Square root
Tan	Tangent
TanH	Hyperbolic tangent
Anti Trigonome	
ACos	Arc cosine
ACosH	Arc hyperbolic cosine
ACotCon	Concave arc cotangent
ACotPro	Protuberant arc cotangen
ACotHCon	Concave arc hyperbolic cotangent
ACotHPro	Protuberant arc hyperbolic cotangent
ACscCon	Concave arc cosecant
ACscPro	Protuberant arc cosecant
ACscHCon	Concave arc hyperbolic cosecant
ACscHPro	Protuberant arc hyperbolic cosecant
ASecCon	Concave arc secant
ASecPro	Protuberant arc secant
ASecH	Arc hyperbolic secant
ASin	Arc Sinc
ASinH	Arc hyperbolic sine
ATan	Arc tangent
ATanH	Arc hyperbolic tangent
Window	
Bartlett	Bartlett window
BarthannWin	Modified Bartlett-Hann window
Blackman	Blackman window

BlackmanH	BlackmanH window
BohmanWin	Bohman window
Boxcar	Rectangle window
ChebWin	Chebyshev window
FlattopWin	Flat Top weighted window
Hamming	Hamming window
Hanning	Hanning window
Kaiser	Kaiser window
NuttallWin	Nuttall-defined minimum 4-term Blackman-Harris window
ParzenWin	Parzen window
TaylorWin	Taylor window
Triang	Triangle window (Fejer window)
TukeyWin	Tukey (tapered cosine) window

User-defined Waveforms

Select the user-defined arbitrary waveform stored in external storage (USB drive).

Loading arbitrary waveform

Edit the ARB waveform by PC software and export the waveform data to the external storage device as .hwf file.

Press **[Wave] > Arb** softkey to enter the arbitrary menu, and press **Type > User** softkey to select the arbitrary waveform file to load.

Chapter 4 Harmonic Output

The HDG3000B(C) can be used as a harmonic generator to output harmonic with specified order, amplitude and phase. It is usually used in the test of harmonic detector device or harmonic filter device.

This chapter introduces how to configure the generator to output harmonics. Subjects in this chapter:

- ◆ **Overview**
- ◆ **Set the Basic Waveform Parameters**
- ◆ **Set the Harmonic Order**
- ◆ **Select the Harmonic Type**
- ◆ **Set the Harmonic Amplitude**
- ◆ **Set the Harmonic Phase**

4.1 Overview

According to Fourier transform, time domain waveform is the superposition of a series of sine waveforms as shown in the equation below:

$$f(t) = A_1 \sin(2\pi f_1 t + \varphi_1) + A_2 \sin(2\pi f_2 t + \varphi_2) + A_3 \sin(2\pi f_3 t + \varphi_3) + \dots$$

Generally, component with f_1 frequency is called basic waveform, f_1 is basic waveform frequency, A_1 is basic waveform amplitude and φ_1 is basic waveform phase. The frequencies of other components (called harmonics) are all integral multiples of the basic waveform frequency. Components whose frequencies are odd multiples of the basic waveform frequency are odd harmonics and components whose frequencies are even multiples of the basic waveform frequency are even harmonics.

HDG3000B(C) can output up to 16th order of harmonic. After selecting CH1 or CH2, press **[Wave] > Harmonic** softkey on the front panel to enter the harmonic setting menu. Users can set the parameters of basic waveform, set the type of harmonic, specify the highest order of harmonic and set the amplitude and phase of each order of harmonic.

After finishing harmonic parameter setting, press **[Output1]** button or (and) **[Output2]** button on the front panel and the backlight of the button turns on, the instrument outputs the specified harmonic from the corresponding output terminal.

4.2 Set the Basic Waveform Parameters

Users can set various basic waveform parameters such as frequency, period, amplitude, DC offset voltage, high level, low level and start phase. It also supports synchronizing phase operation. Please refer to introductions in "[Basic Waveform Output](#)" to set basic waveform parameters.

4.3 Set the Harmonic Order

The highest order of harmonic output cannot be greater than this setting value.

Press **[Wave]>Harmonic** softkey on the front panel to enter the harmonic setting menu, and press **Order** softkey, at this time, the "Order" on the screen is highlighted, use the numeric keypad or the direction keys and the knob to input the corresponding value. The range is limited by the maximum output frequency of the instrument as well as the basic waveform frequency.

- ◆ Range: integers within 2 to **maximum output frequency of the instrument ÷ basic waveform frequency**.
- ◆ The maximum value is 16.

4.4 Set the Harmonic Type

HDG3000B(C) can output even harmonics, odd harmonics or all orders of harmonics. Press **[Wave] > Harmonic** softkey on the front panel to enter the harmonic setting menu, and press **Type** softkey to select the desired harmonic type.

1. Even

Select this type and the instrument would output basic waveform and even harmonics.

2. Odd number

Select this type and the instrument would output basic waveform and odd harmonics.

3. All

Select this type and the instrument would output basic waveform and all the harmonics in order.

Note: The harmonics actually output is determined by the "Order" currently specified.

4.5 Set the Harmonic Amplitude

Press **[Wave] > Harmonic** softkey to enter the harmonic setting menu and press **Amplitude** softkey to set the amplitude of each harmonic.

1. Index: Press this softkey to select the index number of the harmonic to be selected.

2. Amplitude: Press this softkey to set the amplitude of the selected subharmonic. Use the numeric keypad to input the amplitude value and then select the desired unit from the pop-up menu, or use the direction keys and knob to modify the current value.

- ◆ For the input method of amplitude value, please refer to the introduction in "[Parameter Setting Method](#)".
- ◆ The amplitude units available are Vpp and mVpp.

4.6 Set the Harmonic Phase

Press **[Wave] > Harmonic** softkey to enter the harmonic setting menu and press **Phase** softkey to set the phase of each harmonic.

1. Index: Press this softkey to select the index number of the harmonic to be selected.

2. Phase: Press this softkey to set the phase of the selected subharmonic. Use the numeric keypad to input the phase value and then select the unit "°" from the pop-up menu, or use the direction keys and knob to modify the current value. For the input method of phase value, refer to the introduction in "[Parameter Setting Method](#)".

Chapter 5 Modulation

HDG3000B(C) supports AM, DSB-AM, FM, PM, 2ASK, 2FSK, 2PSK, BPSK, QPSK, 3FSK, 4FSK, OSK and PWM modulations. It can output modulated waveform from a single channel or from two channels at the same time. The modulated waveform consists of carrier waveform and modulating waveform. The carrier waveform can be Sine, Square, Ramp, Pulse, Arbitrary waveform (except DC) or Harmonic. The modulating waveform can be from internal (default), other channel, or external modulation source.

- ◆ **AM Modulation**
- ◆ **DSB-AM Modulation**
- ◆ **FM Modulation**
- ◆ **PM Modulation**
- ◆ **2ASK Modulation**
- ◆ **2FSK Modulation**
- ◆ **2PSK Modulation**
- ◆ **BPSK Modulation**
- ◆ **QPSK Modulation**
- ◆ **3FSK Modulation**
- ◆ **4FSK Modulation**
- ◆ **OSK Modulation**
- ◆ **PWM Modulation**

5.1 AM Modulation

A modulated waveform consists of a carrier waveform and a modulating waveform. In AM, the carrier amplitude is varied by the voltage level of the modulating waveform.

5.1.1 Select AM Modulation

Press **[Mod] > Type > AM** softkey to enable AM function.

- ◆ When **Mod** is enabled, **Sweep** or **Burst** will be disabled automatically.
- ◆ After AM is enabled, the instrument will generate AM waveform with the currently specified carrier and modulating waveforms. To avoid multiple waveform changes, enable modulation after configuring the other modulation parameters.

5.1.2 Carrier Waveform Shape

- ◆ AM carrier shape: Sine (default), Square, Ramp, Pulse, Arbitrary (except DC) or Harmonic waveform.
- ◆ Press **[Wave]** button on the front panel to select the desired carrier waveform shape.
- ◆ Noise and DC could not be used as carrier waveform.

5.1.3 Carrier Waveform Frequency

For different carrier waveforms, the settable range of carrier frequency is different. Please refer to "Frequency Characteristics" in "[Specifications](#)". The default value is 1kHz.

Press **[Setting] > Frequency** softkey on the front panel, and then use the numeric keypad or direction keys and knob to input the desired frequency value.

5.1.4 Modulation Source

Press **[Mod] > Signal Source** softkey to select Internal, External or Another Channel as the modulation source.

Internal Source

When internal modulation source is selected, press **Shapes** softkey to select Sine, Square, Ramp, Noise or Arb as the modulation source. The default is Sine.

- ◆ Sine
- ◆ Square: 50% duty cycle
- ◆ Ramp: 50% symmetry.
- ◆ Noise
- ◆ Arb: Sinc, Exp Fall, Haver Sine, Lorentz, Gause, Dual Tone, ECG.

Note: Noise can be used as modulating waveform but cannot be used as carrier waveform.

External Source

When external modulation source is selected, the **Frequency** and **Shape** menu in the modulation menu is grayed out and disabled. The instrument receives the external modulation signal from the **[FSK/Trig/Sync/Extmod]** connector on the rear panel. At this point, the AM modulation amplitude is controlled by the $\pm 4V$ signal level on this connector. For example, when the modulation depth is 100%, the output amplitude is maximum when the external modulation signal is +4V, and the output amplitude is the minimum when the external modulation signal is -4V.

Other Channels

CH1 and CH2 can be used as modulation sources reciprocally. When CH1 is used as the modulated wave, CH2 can be used as the modulation source. And vice versa.

When selecting another channel as the modulation source, please turn on the output of that channel.

5.1.5 Modulation Frequency

When internal modulation source is selected, press **[Mod] > Frequency** softkey to set the frequency of the modulating waveform.

- ◆ Use the numeric keypad or direction keys and knob to enter the desired frequency values.
- ◆ The modulating waveform frequency range is 2mHz to 1MHz, and the default value is 100Hz.

Note: This menu will be grayed out and disabled when other modulation sources except the internal modulation source are selected.

5.1.6 Modulation Depth

The modulation depth is a percentage that represents the amplitude variation.

- ◆ Press **[Mod] > Depth** softkey to set AM modulation depth.
- ◆ Modulation depth range: 0% to 120%. The default is 100%.
- ◆ At 0% depth, the amplitude is one-half of the carrier's amplitude setting.
- ◆ At 100% depth, the output amplitude is equal to the specified value.
- ◆ In >100% modulation, the output amplitude of the instrument would not exceed 10Vpp (50 Ω load).

When external modulation source is select, the output amplitude of the instrument is also controlled by the $\pm 4V$ signal level on the **[FSK/Trig/Sync/Extmod]** connector on the rear panel. For example, set the modulation depth to 100%, the output amplitude is the maximum when the modulating signal is +4V and the minimum when the modulating signal is -4V.

5.2 DSB-AM Modulation

In the Double-sideband AM signal, there are only two side frequencies, and there is no carrier component. Its frequency bandwidth is still twice the frequency of the modulated signal.

5.2.1 Select DSB-AM Modulation

Press [**Mod**] > **Type** > **DSB-AM** softkey to enable DSB-AM function.

- ◆ When **Mod** is enabled, **Sweep** or **Burst** will be disabled automatically.
- ◆ After DSB-AM is enabled, the instrument will generate DSB-AM waveform with the currently specified carrier and modulating waveforms. To avoid multiple waveform changes, enable modulation after configuring the other modulation parameters.

5.2.2 Carrier Waveform Shape

- ◆ DSB-AM carrier shape: Sine (default), Square, Ramp, Pulse, Arbitrary (except DC) or Harmonic waveform.
- ◆ Press [**Wave**] button on the front panel to select the desired carrier waveform.
- ◆ Noise and DC could not be used as carrier waveform.

5.2.3 Carrier Waveform Frequency

For different carrier waveforms, the settable range of carrier frequency is different. please refer to "Frequency Characteristics" in "[Specifications](#)". The default value is 1kHz.

Press [**Setting**] > **Frequency** softkey on the front panel, and then use the numeric keypad or direction keys and knob to input the desired frequency value.

5.2.4 Modulation Source

Press [**Mod**] > **Signal Source** softkey to select Internal, External or Another Channel as the modulation source.

Internal Source

When internal modulation source is selected, press **Shape** softkey to select Sine, Square, Ramp, Noise or Arb as the modulation source. The default is Sine.

- ◆ Sine
- ◆ Square: 50% duty cycle
- ◆ Ramp: 50% symmetry.
- ◆ Noise
- ◆ Arb: Sinc, Exp Fall, Haver Sine, Lorentz, Gause, Dual Tone, ECG.

Note: Noise can be used as modulating waveform but cannot be used as carrier waveform.

External Source

When external modulation source is selected, the **Frequency** and **Shape** menu in the modulation menu is grayed out and disabled. The instrument receives the external modulation signal from the [**FSK/Trig/Sync/Extmod**] connector on the rear panel. At this point, the AM modulation amplitude is controlled by the $\pm 4V$ signal level on this connector. For example, when the modulation depth is

100%, the output amplitude is maximum when the external modulation signal is +4V, and the output amplitude is the minimum when the external modulation signal is -4V.

Other Channels

CH1 and CH2 can be used as modulation sources reciprocally. When CH1 is used as the modulated wave, CH2 can be used as the modulation source. And vice versa.

When selecting another channel as the modulation source, please turn on the output of that channel.

5.2.5 Modulation Frequency

When internal modulation source is selected, press **[Mod] >Frequency** softkey to set the frequency of the modulating waveform.

- ◆ Use the numeric keypad or direction keys and knob to enter the desired frequency values.
- ◆ The modulating waveform frequency range is 2mHz to 1MHz, and the default value is 100Hz.

Note: This menu will be grayed out and disabled when other modulation sources except the internal modulation source are selected.

5.2.6 Modulation Depth

The modulation depth represents the degree of amplitude variation, expressed as a percentage. The modulation depth of DSB-AM can be set from 0% to 120%.

- ◆ Press **[Mod] > Depth** softkey to set DSB-AM modulation depth.
- ◆ Modulation depth range: 0% to 120%. The default is 100%.
- ◆ At 0% modulation, no signal is output.
- ◆ At 50% depth, the DSB-AM amplitude is 1/4 of the carrier waveform amplitude.
- ◆ At 100% depth, the DSB-AM amplitude is half of the carrier waveform amplitude.
- ◆ In >100% modulation, the DSB-AM amplitude of the instrument would not exceed 10Vpp (50Ω load).

When external modulation source is select, the output amplitude of the instrument is also controlled by the $\pm 4V$ signal level on the **[FSK/Trig/Sync/Extmod]** connector on the rear panel. For example, set the modulation depth to 100%, the output amplitude is the maximum when the modulating signal is +4V or -4V, and the output amplitude is the minimum when the modulating signal is 0V.

5.3 FM Modulation

A modulated waveform consists of a carrier waveform and a modulating waveform. In FM, the carrier frequency is varied by the voltage level of the modulating waveform.

5.3.1 Select FM Modulation

Press **[Mod] > Type > FM** softkey to enable FM function.

- ◆ When **Mod** is enabled, **Sweep** or **Burst** will be disabled automatically.
- ◆ After FM is enabled, the instrument will generate FM waveform with the currently specified carrier and modulating waveforms. To avoid multiple waveform changes, enable modulation after configuring the other modulation parameters.

5.3.2 Carrier Waveform Shape

FM carrier shape: Sine (default), Square, Ramp, Pulse, Arbitrary (except DC) or Harmonic waveform.

- ◆ Press **[Wave]** button on the front panel to select the desired carrier waveform.
- ◆ Noise and DC could not be used as carrier waveform.

5.3.3 Carrier Waveform Frequency

For different carrier waveforms, the settable range of carrier frequency is different. please refer to "Frequency Characteristics" in "[Specifications](#)". The default value is 1kHz.

Press **[Setting] > Frequency** softkey on the front panel, and then use the numeric keypad or direction keys and knob to input the desired frequency value.

5.3.4 Modulation Source

Press **[Mod] > Signal Source** softkey to select Internal, External or Another Channel as the modulation source.

Internal Source

When internal modulation source is selected, press **Shape** softkey to select Sine, Square, Ramp, Noise or Arb as the modulation source. The default is Sine.

- ◆ Sine
- ◆ Square: 50% duty cycle
- ◆ Ramp: 50% symmetry.
- ◆ Noise
- ◆ Arb: Sinc, Exp Fall, Haver Sine, Lorentz, Gause, Dual Tone, ECG.

Note: Noise can be used as modulating waveform but cannot be used as carrier waveform.

External source

When external modulation source is selected, the **Frequency** and **Shape** menu in the modulation menu is grayed out and disabled. The instrument receives the external modulation signal from the **[FSK/Trig/Sync/Extmod]** connector on the rear panel. At this point, the FM modulation frequency deviation is controlled by the $\pm 4V$ signal level on the connector.

Other Channels

CH1 and CH2 can be used as modulation sources reciprocally. When CH1 is used as the modulated wave, CH2 can be used as the modulation source. And vice versa.

When selecting another channel as the modulation source, please turn on the output of that channel.

5.3.5 Modulation Frequency

When internal modulation source is selected, press **[Mod] >Frequency** softkey to set the frequency of the modulating waveform.

- ◆ Use the numeric keypad or direction keys and knob to enter the desired frequency values.
- ◆ The modulating waveform frequency range is 2mHz to 1MHz, and the default value is 100Hz.

Note: This menu will be grayed out and disabled when other modulation sources except the internal modulation source are selected.

5.3.6 Frequency Deviation

Frequency deviation is the deviation of the modulating waveform frequency relative to the carrier frequency. Press **[Mod] > Deviations** softkey to set the FM frequency deviation.

- ◆ Frequency deviation must be lower than or equal to the carrier frequency.
- ◆ Attempting to set a deviation greater than the carrier frequency will cause the instrument to set the deviation equal to the carrier frequency.
- ◆ The sum of frequency deviation and carrier frequency must be lower than or equal to the sum of the current carrier frequency upper limit and 1kHz.
- ◆ Use the numeric keypad or direction keys and knob to input the desired frequency values.

When external modulation source is selected, the frequency deviation is controlled by the $\pm 4V$ signal level on the **[FSK/Trig/Sync/Extmod]** connector on the rear panel. Positive signal level corresponds to frequency increase and negative signal level corresponds to frequency decrease. The lower the level, the less offset is generated. For example, if the frequency deviation is set to 1kHz, +4V signal level corresponds to a 1kHz increase of frequency and -4V signal level corresponds to a 1kHz decrease of frequency.

5.4 PM Modulation

A modulated waveform consists of a carrier waveform and a modulating waveform. In PM, the carrier phase is varied by the voltage level of the modulating waveform.

5.4.1 Select PM Modulation

Press [**Mod**] > **Type** > **PM** softkey to enable PM function.

- ◆ When **Mod** is enabled, **Sweep** or **Burst** will be disabled automatically.
- ◆ After PM is enabled, the instrument will generate PM waveform with the currently specified carrier and modulating waveforms. To avoid multiple waveform changes, enable modulation after configuring the other modulation parameters.

5.4.2 Carrier Waveform Shape

PM carrier shape: Sine (default), Square, Ramp, Pulse, Arbitrary (except DC) or Harmonic waveform.

- ◆ Press [**Wave**] button on the front panel to select the desired carrier waveform.
- ◆ Noise and DC could not be used as carrier waveform.

5.4.3 Carrier Waveform Frequency

For different carrier waveforms, the settable range of carrier frequency is different. please refer to "Frequency Characteristics" in "[Specifications](#)". The default value is 1kHz.

Press [**Setting**] > **Frequency** softkey on the front panel, and then use the numeric keypad or direction keys and knob to input the desired frequency value.

5.4.4 Modulation Source

Press [**Mod**] > **Signal Source** softkey to select Internal, External or Another Channel as the modulation source.

Internal Source

When internal modulation source is selected, press **Shape** softkey to select Sine, Square, Ramp, Noise or Arb as the modulation source. The default is Sine.

- ◆ Sine
- ◆ Square: 50% duty cycle
- ◆ Ramp: 50% symmetry.
- ◆ Noise
- ◆ Arb: Sinc, Exp Fall, Haver Sine, Lorentz, Gause, Dual Tone, ECG.

Note: Noise can be used as modulating waveform but cannot be used as carrier waveform.

External Source

When external modulation source is selected, the **Frequency** and **Shape** menu in the modulation menu is grayed out and disabled. The instrument receives the external modulation signal from the [**FSK/Trig/Sync/Extmod**] connector on the rear panel. At this point, the PM modulation phase deviation is controlled by the $\pm 4V$ signal level on the connector.

Other Channels

CH1 and CH2 can be used as modulation sources reciprocally. When CH1 is used as the modulated wave, CH2 can be used as the modulation source. And vice versa.

When selecting another channel as the modulation source, please turn on the output of that channel.

5.4.5 Modulation Frequency

When internal modulation source is selected, press **[Mod] >Frequency** softkey to set the frequency of the modulating waveform.

- ◆ Use the numeric keypad or direction keys and knob to enter the desired frequency values.
- ◆ The modulating waveform frequency range is 2mHz to 1MHz, and the default value is 100Hz.

Note: This menu will be grayed out and disabled when other modulation sources except the internal modulation source are selected.

5.4.6 Phase Deviation

Phase deviation is the deviation of the modulating waveform phase relative to the carrier waveform phase. Press **[Mod] > Deviation** softkey to set the PM phase deviation.

- ◆ Use the numeric keypad or direction keys and knob to input the desired phase values.
- ◆ The phase deviation is set to 0 ° to 360 °.

When external modulation source is selected, the phase deviation is controlled by the $\pm 4V$ signal level on the **[FSK/Trig/Sync/Extmod]** connector on the rear panel. For example, if the phase deviation is set to 180 °, +4V signal level corresponds to a 180° phase variation. The lower the external signal level, the less deviation would be generated.

5.5 ASK Modulation

Users can configure the instrument to "shift" its output amplitude between two preset values using ASK modulation. The rate at which the output shifts between the two amplitudes (called the "carrier amplitude" and the "modulation amplitude") is determined by the internal signal level of the instrument or the external signal level on the **[FSK/Trig/Sync/Extmod]** connector on the rear panel.

5.5.1 Select ASK modulation

Press **[Mod] >Type > ASK** softkey to enable this function.

- ◆ When **Mod** is enabled, **Sweep** or **Burst** will be disabled automatically.
- ◆ After ASK is enabled, the instrument will generate ASK waveform with the currently specified

carrier and modulating waveforms. To avoid multiple waveform changes, enable modulation after configuring the other modulation parameters.

5.5.2 Carrier Waveform Shape

ASK carrier shape: Sine (default), Square, Ramp, Pulse, Arbitrary (except DC) or Harmonic waveform.

- ◆ Press **[Wave]** button on the front panel to select the desired carrier waveform.
- ◆ Noise and DC could not be used as carrier waveform.

5.5.3 Carrier Waveform Amplitude

After selecting the carrier waveform, press **[Setting]>Amplitude** softkey on the front panel, use the numeric keypad or direction keys and knob to input the desired amplitude. The amplitude range is limited by frequency. Please refer to the "Output Characteristics" described in ["Specifications"](#).

5.5.4 Modulation Source

Press **[Mod] > Signal Source** to select Internal or External Modulation Source.

Internal Source

When internal modulation source is selected, the modulating waveform is set as a Square with 50% duty cycle, and the rate at which the output amplitude "shifts" between "carrier amplitude" and "modulating amplitude" is determined by "ASK Rate".

External Source

When external modulation source is selected, the generator receives the external modulating signal from the **[FSK/Trig/Sync/Extmod]** connector on the rear panel.

Note: The **[FSK/Trig/Sync/Extmod]** connector is different when controlling ASK and AM/FM/PM modulations externally.

5.5.5 ASK Rate

When internal modulation source is selected, press **[Mod] > Rate** softkey to set the rate at which the output amplitude shifts between "carrier amplitude" and "modulation amplitude".

- ◆ Use the numeric keypad or direction keys and knob to input the desired rate value.
- ◆ The rate range is from 2mHz to 1MHz and the default is 100Hz.

Note: This menu will be grayed out and disabled when the external modulation source is selected.

5.5.6 Modulation Amplitude

After enabling ASK modulation function, press **[Mod]>Amplitude** softkey to set the modulation amplitude.

- ◆ Use the numeric keypad or direction keys and knob to input the desired amplitude value.
- ◆ The range of amplitude (HighZ) is from 2mV to 20V and the default is 100mV.

5.6 FSK Modulation

Users can configure the instrument to "shift" its output frequency between two preset values using FSK modulation. The rate at which the output shifts between the two frequencies (called the "carrier frequency" and the "hop frequency") is determined by the internal signal level of the instrument or the signal level on the **[FSK/Trig/Sync/Extmod]** connector on the rear panel.

5.6.1 Select FSK Modulation

Press **[Mod] >Type > FSK** softkey to enable FSK function.

- ◆ When **Mod** is enabled, **Sweep** or **Burst** will be disabled automatically.
- ◆ After FSK is enabled, the instrument will generate FSK waveform with the currently specified carrier and modulating waveforms. To avoid multiple waveform changes, enable modulation after configuring the other modulation parameters.

5.6.2 Carrier Waveform Shape

FSK carrier shape: Sine (default), Square, Ramp, Pulse, Arbitrary (except DC) or Harmonic waveform.

- ◆ Press **[Wave]** button on the front panel to select the desired carrier waveform.
- ◆ Noise and DC could not be used as carrier waveform.

5.6.3 Carrier Waveform Frequency

For different carrier waveforms, the settable range of carrier frequency is different. please refer to "Frequency Characteristics" in "[Specifications](#)". The default value is 1kHz.

Press **[Setting] > Frequency** softkey on the front panel, and then use the numeric keypad or direction keys and knob to input the desired frequency value.

5.6.4 Modulation Source

Press **[Mod] > SignalSource** softkey to select Internal (default) or External as the modulation source.

Internal Source

When internal modulation source is selected, the modulating waveform is set as a Square with 50% duty cycle, and the rate at which the output frequency "shifts" between "carrier frequency" and "modulating frequency" is determined by "FSK Rate".

External Source

When external modulation source is selected, the generator receives the external modulating signal from the **[FSK/Trig/Sync/Extmod]** connector on the rear panel.

Note: The **[FSK/Trig/Sync/Extmod]** connector is different when controlling FSK and AM/FM/PM modulations externally.

5.6.5 FSK Rate

When internal modulation source is selected, press **[Mod] > Rate** softkey to set the rate at which the output frequency shifts between "carrier frequency" and "hopping frequency".

- ◆ Use the numeric keypad or direction keys and knob to input the desired rate value.
- ◆ The rate range is from 2mHz to 1MHz and the default is 100Hz.

Note: This menu will be grayed out and disabled when the external modulation source is selected.

5.6.6 HoppingFrequency

The range of hopping frequency depends on the carrier waveform currently selected. Refer to "Frequency Characteristics" in "[Specifications](#)".

Press **[Mod]>Hoppings** softkey. Use the numeric keypad or direction keys and knob to input the desired frequency value.

5.7 PSK Modulation

Users can configure the instrument to "shift" its output phase between two preset values using PSK modulation. The rate at which the output shifts between the two phases (called the "carrier phase" and the "modulation phase") is determined by the internal signal level of the instrument or the signal level on the **[FSK/Trig/Sync/Extmod]** connector on the rear panel.

5.7.1 Select PSK Modulation

Press **[Mod] >Type > PSK** softkey to enable PSK function.

- ◆ When **Mod** is enabled, **Sweep** or **Burst** will be disabled automatically.
- ◆ After PSK is enabled, the instrument will generate PSK waveform with the currently specified carrier and modulating waveforms. To avoid multiple waveform changes, enable modulation after configuring the other modulation parameters.

5.7.2 Carrier Waveform Shape

PSK carrier shape: Sine (default), Square, Ramp, Pulse, Arbitrary (except DC) or Harmonic waveform.

- ◆ Press **[Wave]** button on the front panel to select the desired carrier waveform.
- ◆ Noise and DC could not be used as carrier waveform.

5.7.3 Carrier Waveform Phase

Press **[Setting] >Phase** softkey on the front panel and use the numeric keypad or direction keys and knob to input the desired phase.

The available phase ranges from 0° to 360° and the default value is 0°.

5.7.4 Modulation Source

Press **[Mod] > SignalSource** to select Internal or External modulation source.

Internal Source

When internal modulation source is selected, the modulating waveform is set as a Square with 50% duty cycle, and the rate at which the output phase "shifts" between "carrier phase" and "modulation phase" is determined by "PSK Rate".

External source

When external modulation source is selected, the generator receives the external modulating signal from the **[FSK/Trig/Sync/Extmod]** connector on the rear panel.

Note: The **[FSK/Trig/Sync/Extmod]** connector is different when controlling PSK and AM/FM/PM modulations externally.

5.7.5 PSK Rate

When internal modulation source is selected, press **[Mod] > Rate** softkey to set the rate at which the output phase shifts between "carrier phase" and "modulation phase".

- ◆ Use the numeric keypad or direction keys and knob to input the desired rate value.
- ◆ The rate range is from 2mHz to 1MHz and the default is 100Hz.

Note: This menu will be grayed out and disabled when the external modulation source is selected.

5.7.6 Modulation Phase

Press **[Mod]> phase** softkey to set the modulation phase.

- ◆ Use the numeric keypad or direction keys and knob to input the desired phase value.
- ◆ The phase range is from 0° to 360° and the default is 180°.

5.8 BPSK Modulation

Users can configure the instrument to "shift" its output phase between two preset values using BPSK modulation. The rate at which the output shifts between the two phases (called the "carrier phase" and the "modulation phase") is determined by the internal signal level of the instrument.

5.8.1 Select BPSK Modulation

Press **[Mod] >Type > BPSK** softkey to enable the BPSK function.

- ◆ When **Mod** is enabled, **Sweep** or **Burst** will be disabled automatically.
- ◆ After BPSK is enabled, the instrument will generate BPSK waveform with the currently specified carrier and modulating waveforms. To avoid multiple waveform changes, enable modulation after configuring the other modulation parameters.

5.8.2 Carrier Waveform Shape

BPSK carrier shape: Sine (default), Square, Ramp, Pulse, Arbitrary (except DC) or Harmonic waveform.

- ◆ Press **[Wave]** button on the front panel to select the desired carrier waveform.
- ◆ Noise and DC could not be used as carrier waveform.

5.8.3 Carrier Waveform Phase

Press **[Setting] >Phases** softkey on the front panel and use the numeric keypad or direction keys and knob to input the desired phase.

The available phase ranges from 0° to 360° and the default value is 0°.

5.8.4 Modulation Source

BPSK uses internal modulation source. After enabling BPSK modulation function, press **[Mod] >Data Source** softkey, and select 01 code, 10 code, PN15 code or PN21 code as the modulation source. The default data source is 01 code.

5.8.5 BPSK Rate

When internal modulation source is selected, press **[Mod] > Rate** softkey to set the rate at which the output phase shifts between "carrier phase" and "modulation phase".

- ◆ Use the numeric keypad or direction keys and knob to input the desired rate value.
- ◆ The rate range is from 2mHz to 1MHz and the default is 100Hz.

5.8.6 Modulation Phase

Pressing **[Mod]>Phase** softkey to set the modulation phase.

- ◆ Use the numeric keypad or direction keys and knob to input the desired phase values.
- ◆ The phase range is from 0° to 360° and the default is 180°.

5.9 QPSK Modulation

Users can configure the instrument to "shift" its output phase between four preset values using QPSK modulation. The rate at which the output shifts between the four phases (called the "carrier phase" and three "modulation phases") is determined by the internal signal level of the instrument.

5.9.1 Select QPSK Modulation

Press **[Mod] >Type > QPSK** softkey to enable QPSK function.

- ◆ When **Mod** is enabled, **Sweep** or **Burst** will be disabled automatically.
- ◆ After QPSK is enabled, the instrument will generate QPSK waveform with the currently specified carrier and modulating waveforms. To avoid multiple waveform changes, enable modulation after configuring the other modulation parameters.

5.9.2 Carrier Waveform Shape

QPSK carrier shape: Sine (default), Square, Ramp, Pulse, Arbitrary (except DC) or Harmonic waveform.

- ◆ Press **[Wave]** button on the front panel to select the desired carrier waveform.
- ◆ Noise and DC could not be used as carrier waveform.

5.9.3 Carrier WaveformPhase

Press **[Setting] >Phase** softkey on the front panel and use the numeric keypad or direction keys and knob to input the desired phase.

The available phase ranges from 0° to 360° and the default value is 0°.

5.9.4 Modulation Source

QPSK uses the internal modulation source. After enabling QPSK modulation function, press **[Mod] >Data Source** softkey, and select PN15 and PN21 codes as the modulation source. The default is PN15 code.

5.9.5 QPSK Rate

When internal modulation source is selected, press **[Mod] > Rate** softkey to set the rate at which the output phase shifts between "carrier phase" and three "modulation phases".

- ◆ Use the numeric keypad or direction keys and knob to input the desired rate value.
- ◆ The rate range is from 2mHz to 1MHz and the default is 100Hz.

5.9.6 Modulation Phase

Press **[Mod]> Phase1** or **Phase2/Phase3** softkeys to set the parameter.

- ◆ Use the numeric keypad or direction keys and knob to input the desired amplitude value.
- ◆ The phase range is from 0° to 360°. The default is 180°. The default values for phases 1, 2, and 3 are 45°, 135°, and 225°, respectively.

5.10 3FSK Modulation

Users can configure the instrument to "shift" its output frequency between three preset values using 3FSK modulation. The rate at which the output shifts between the three frequencies (called the "carrier frequency" and two "hop frequencies") is determined by the internal signal level of the instrument.

5.10.1 Select 3FSK Modulation

Press **[Mod] >Type > 3FSK** softkey to enable 3FSK function.

- ◆ When **Mod** is enabled, **Sweep** or **Burst** will be disabled automatically.
- ◆ After 3FSK is enabled, the instrument will generate 3FSK waveform with the currently specified carrier and modulating waveforms. To avoid multiple waveform changes, enable modulation after configuring the other modulation parameters.

5.10.2 Carrier Waveform Shape

3FSK carrier shape: Sine (default), Square, Ramp, Pulse, Arbitrary (except DC) or Harmonic waveform.

- ◆ Press **[Wave]** button on the front panel to select the desired carrier waveform.
- ◆ Noise and DC could not be used as carrier waveform.

5.10.3 Carrier Waveform Frequency

For different carrier waveforms, the settable range of carrier frequency is different. please refer to "Frequency Characteristics" in "[Specifications](#)". The default value is 1kHz.

Press [**Setting**] > **Frequency** softkey on the front panel, and then use the numeric keypad or direction keys and knob to input the desired frequency value.

5.10.4 Modulation Source

3FSK uses internal modulation source. The modulating waveform is square.

5.10.5 3FSK Rate

When internal modulation source is selected, press [**Mod**] > **Rate** softkey to set the rate at which the output frequency shifts between "carrier frequency" and two "hopping frequencies".

- ◆ Use the numeric keypad or direction keys and knob to input the desired rate value.
- ◆ The rate range is from 2mHz to 1MHz and the default is 100Hz.

5.10.6 HoppingFrequency

The range of hopping frequency depends on the carrier waveform currently selected. Refer to "Frequency Characteristics" in "[Specifications](#)".

Press [**Mod**] > **Hopping** softkey. Use the numeric keypad or direction keys and knob to input the desired frequency value.

5.11 4FSK Modulation

Users can configure the instrument to "shift" its output frequency between four preset values using 4FSK modulation. The rate at which the output shifts between the four frequencies (called the "carrier frequency" and three "hop frequencies") is determined by the internal signal level of the instrument.

5.11.1 Select 4FSK Modulation

Press [**Mod**] > **Type** > **4FSK** softkey to enable 4FSK function.

- ◆ When **Mod** is enabled, **Sweep** or **Burst** will be disabled automatically.
- ◆ After 4FSK is enabled, the instrument will generate 4FSK waveform with the currently specified carrier and modulating waveforms. To avoid multiple waveform changes, enable modulation after configuring the other modulation parameters.

5.11.2 Carrier Waveform Shape

4FSK carrier shape: Sine (default), Square, Ramp, Pulse, Arbitrary (except DC) or Harmonic waveform.

- ◆ Press [**Wave**] button on the front panel to select the desired carrier waveform.
- ◆ Noise and DC could not be used as carrier waveform.

5.11.3 Carrier Waveform Frequency

For different carrier waveforms, the settable range of carrier frequency is different. please refer to "Frequency Characteristics" in "[Specifications](#)". The default value is 1kHz.

Press **[Setting] > Frequency** softkey on the front panel, and then use the numeric keypad or direction keys and knob to input the desired frequency value.

5.11.4 Modulation Source

4FSK uses internal modulation source. The modulating waveform is square.

5.11.5 4FSK Rate

When internal modulation source is selected, press **[Mod] > Rate** softkey to set the rate at which the output frequency shifts between "carrier frequency" and three "hopping frequencies".

- ◆ Use the numeric keypad or direction keys and knob to input the desired rate value.
- ◆ The rate range is from 2mHz to 1MHz and the default is 100Hz.

5.11.6 HoppingFrequency

The range of hopping frequency depends on the carrier waveform currently selected. Refer to "Frequency Characteristics" in "[Specifications](#)".

Press **[Mod] > Hopping** softkey. Use the numeric keypad or direction keys and knob to input the desired frequency value.

5.12 OSK Modulation

When OSK (Oscillation Shift Keying) modulation is selected, users can configure the generator to output a sine signal with intermittent oscillation as shown in the figure below (the carrier waveform is 100Hz and the OSK rate is 1kHz). The start-oscillation and stop-oscillation of the internal crystal oscillator are controlled by the internal signal level or signal level from the **[FSK/Trig/Sync/Extmod]** connector on the rear panel. When the internal crystal oscillator starts to oscillate, the instrument starts to output the carrier waveform and when the internal crystal stops oscillating, the output stops.

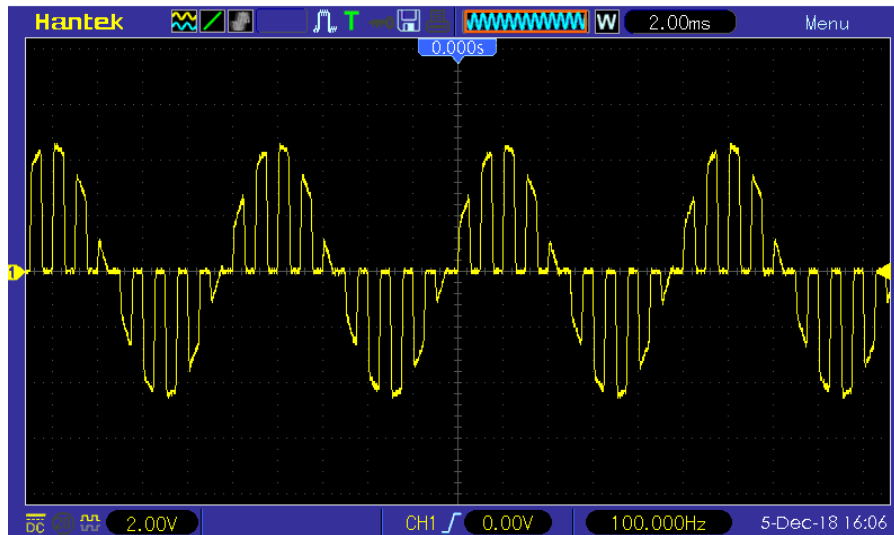

5.12.1 Select OSK Modulation

Press **[Mod]** > **Type** > **OSK** softkey to enable OSK function.

- ◆ When **Mod** is enabled, **Sweep** or **Burst** will be disabled automatically.
- ◆ After OSK is enabled, the instrument will generate OSK waveform with the currently specified carrier and modulating waveforms. To avoid multiple waveform changes, enable modulation after configuring the other modulation parameters.

5.12.2 Carrier Waveform Shape

OSK carrier waveform can only be sine waveform. Press **[Wave]** > **Sine** softkey on the front panel to select.

5.12.3 Carrier Waveform Frequency

For different carrier waveforms, the settable range of carrier frequency is different. Please refer to "Frequency Characteristics" in [Specifications](#). The default value is 1kHz.

Press **[Setting]** > **Frequency** softkey on the front panel, and then use the numeric keypad or direction keys and knob to input the desired frequency value.

5.12.4 Modulation Source

Press **[Mod]** > **Source** softkey to select Internal (default) or External as the modulation source.

Internal Source

When internal modulation source is selected, the modulating waveform is set as a Square with 50% duty cycle, and the intermittence time and oscillate time of the output signal is determined by the OSK "Rate".

External Source

When external modulation source is selected, the signal generator receives the external modulation signal from the **[FSK/Trig/Sync/Extmod]** connector on the rear panel.

5.12.5 OSK Rate

When internal modulation source is selected, press **[Mod] > Rate** softkey to set.

- ◆ Use the numeric keypad or direction keys and knob to input the desired rate value.
- ◆ The rate range is from 2mHz to 1MHz and the default is 100Hz.

Note: This menu will be grayed out and disabled when the external modulation source is selected.

5.12.6 Oscillate Time

Oscillate time is the oscillation period of internal crystal oscillator. The settable range of the oscillate time is related to the OSK rate currently selected. Press **[Mod] > OscTime** softkey and use the numeric keypad or direction keys and knob to input the desired time. The default range is from 8ns to 4.99975ms.

5.13 PWM Modulation

A modulated waveform consists of a carrier waveform and a modulating waveform. In PWM, the pulse width of the carrier waveform varies with the voltage level of the modulating waveform.

5.13.1 Select PWM Modulation

PWM is only available for the Square waveform.

Press **[Wave] > Square** softkey, and then press **[Mod] > Type > PWM** softkey to enable the PWM function.

- ◆ If the **Square** function has not been selected as carrier waveform, PWM in **[Mod] > Type** menu is unavailable.
- ◆ When **Mod** is enabled, **Sweep** or **Burst** will be automatically disabled (if enabled currently).
- ◆ After PWM is enabled, the instrument will generate PWM waveform with the currently specified carrier and modulating waveforms.

5.13.2 Carrier Waveform Shape

PWM is only available for the Square waveform. Press **[Wave]>Square**.

5.13.3 Carrier Waveform Duty

Press **[Wave] > Square** softkey to select square as carrier waveform. Press **[Setting] > Duty** softkey, then input the required value through the numeric keypad or knob.

5.13.4 Modulation Source

Press **[Mod] > Signal Source** softkey to select Internal, External or Another Channel as the modulation source.

Internal Source

When internal modulation source is selected, press **Shape** softkey to select Sine, Square, Ramp, Noise or Arb as the modulation source. The default is Sine.

- ◆ Sine
- ◆ Square: 50% duty cycle
- ◆ Ramp: 50% symmetry.
- ◆ Noise
- ◆ Arb: Sinc, Exp Fall, Haver Sine, Lorentz, Gause, Dual Tone, ECG.

Note: Noise can be used as modulating waveform but cannot be used as carrier waveform.

External Source

When external modulation source is selected, the **Frequency** and **Shape** menu in the modulation menu is grayed out and disabled. The instrument receives the external modulation signal from the **[FSK/Trig/Sync/Extmod]** connector on the rear panel. The Duty Deviation is controlled by $\pm 4V$ signal level on this connector.

Other Channels

CH1 and CH2 can be used as modulation sources reciprocally. When CH1 is used as the modulated wave, CH2 can be used as the modulation source. And vice versa.

When selecting another channel as the modulation source, please turn on the output of that channel.

5.13.5 Modulation Frequency

When internal modulation source is selected, press **[Mod] > Frequency** softkey to set the frequency of the modulating waveform.

- ◆ Use the numeric keypad or direction keys and knob to enter the desired frequency value.
- ◆ The modulating waveform frequency range is 2mHz to 1MHz, and the default value is 100Hz.

Note: This menu will be grayed out and disabled when other modulation sources except the internal modulation source is selected.

5.13.6 Duty Deviation

Press **[Mod]>deviation** softkey and input the desired value using the numeric keypad or direction keys and knob.

Duty deviation represents the variation (in %) of the modulated waveform Duty relative to the original pulse Duty.

- ◆ Duty deviation range: 0.1% to 49.9%.
- ◆ The Duty deviation cannot exceed the current pulse Duty.
- ◆ Duty deviation is limited by the minimum Duty and current edge time setting.

When external modulation source is select, the Duty deviation is controlled by the $\pm 4V$ signal level on the **[FSK/Trig/Sync/Extmod]** connector on the rear panel.

Chapter 6 Sweep

In sweep mode, the instrument outputs the waveform that changes from the start frequency to the stop frequency at a specified sweep rate. HDG3000B(C) supports linear sweep mode.

Users can configure the instrument to output one sweep from start frequency to stop frequency by applying an external or manual trigger. The instrument can sweep sine, square, pulse, ramp, Harmonic or arbitrary waveforms (except DC).

- ◆ **Select Sweep**
- ◆ **Start Frequency and Stop Frequency**
- ◆ **Center Frequency and Frequency Span**
- ◆ **Linear Sweep**
- ◆ **Sweep Time**
- ◆ **Return Time**
- ◆ **Hold Time**
- ◆ **Mark Frequency**
- ◆ **Sweep Trigger Source**
- ◆ **Trigger Output Edge**

6.1 Select Sweep

Press **[Sweep]** button on the front panel to enable the Sweep function (the backlight of the key goes on), and **Mod** or **Burst** function will be automatically disabled (if currently enabled).

To avoid multiple waveform changes, enable the sweep mode after configuring the other parameters (as waveforms and amplitudes of basic waves).

Press **[Sweep]** button again to close sweep mode.

6.2 Start Frequency and Stop Frequency

The generator sweeps from the start frequency to the stop frequency and then returns back to the start frequency.

- ◆ Start Frequency < Stop Frequency: the generator sweeps from low frequency to high frequency.
- ◆ Start Frequency > Stop Frequency: the generator sweeps from high frequency to low frequency.
- ◆ Start Frequency = Stop Frequency: the generator outputs with a fixed frequency.

When **[Sweep]** is enabled, press **Start Frequency/Center Frequency** softkey to highlight the "**Start Frequency**". The "**Stop Frequency**" in the **Stop Frequency/Frequency Spans** softkey is also highlighted. Use the numeric keyboard or direction keys and knob to input the desired frequencies. By default, the start frequency is 100Hz and the stop frequency is 1KHz. Different sweep waveform corresponds to different start frequency and stop frequency range. For frequency parameters of different waveforms, please refer to "Frequency Characteristics" in "[Specifications](#)".

After modifying the frequency, the generator will restart to output the frequency sweep signal with the specified frequency.

6.3 Center Frequency and Frequency Span

Users can also set the sweep frequency boundaries of the sweep using a center frequency and frequency span.

- ◆ Center Frequency = (Start Frequency + Stop Frequency) / 2
- ◆ Frequency Span = Stop Frequency – Start Frequency

When **[Sweep]** is enabled, press **Start Frequency/Center Frequency** softkey to highlight "**Center Frequency**". The "**Frequency Span**" in the **Stop Frequency/Frequency Spans** softkey is also highlighted. Use the numeric keyboard or direction keys and knob to enter the desired frequency values. By default, the center frequency is 550Hz and the frequency span is 900Hz. Different sweep waveform corresponds to different center frequency and frequency span range and center frequency and frequency span are inter-related.

Define the minimum frequency of the waveform currently selected as F_{min} , the maximum frequency as F_{max} and $F_m = (F_{min} + F_{max})/2$.

The range of center frequency is from F_{min} to F_{max} . For frequency parameters of different waveforms, please refer to "Frequency Characteristics" in "[Specifications](#)".

The range of the frequency span is influenced by the center frequency:

Center frequency $< F_m$: frequency span range is $\pm 2 \times (\text{center frequency} - F_{min})$;

Center frequency $\geq F_m$: frequency span range is $\pm 2 \times (F_{max} - \text{center frequency})$.

Take sine as an example. F_{min} is 1 μ Hz, F_{max} is 160MHz and F_m is about 80MHz.

If the center frequency is 550Hz, the range of the frequency span is:

$$\pm 2 \times (550\text{Hz} - 1\mu\text{Hz}) = \pm 1.099999998\text{kHz};$$

if the center frequency is 155MHz, the range of the frequency span range is:

$$\pm 2 \times (160\text{MHz} - 155\text{MHz}) = \pm 10\text{MHz}.$$

After modifying the frequency, the generator will restart to output the frequency sweep signal with the specified frequency.

Note: In large-scale sweep, the amplitude characteristic of the output signal might change.

6.4 Linear Sweep

HDG3000B(C) provides linear sweep type.

The output frequency of the instrument varies linearly in the way of "several Hertz per second". The variation is controlled by "Start Frequency", "Stop Frequency" and "Sweep Time".

6.5 Sweep Time

Sweep time specifies the time required to sweep from the start frequency to the stop frequency.

When [**Sweep**] is enabled, press **Sweep Times** softkey and use the numeric keyboard or knob to change the sweep time.

The default value is 1s and the settable range is from 1ms to 50Ks.

6.6 Return Time

Return time specifies the number of seconds to return from the stop frequency to the start frequency.

When [**Sweep**] is enabled, press the **Return Time** softkey and use the numeric keyboard or knob to change the return time.

The default value is 1s and the settable range is from 1ms to 50Ks.

6.7 Hold Time

The hold time specifies how long time the waveform stays at the stop frequency.

When **[Sweep]** is enabled, press the **Hold Time** softkey and use the numeric keyboard or knob to change the hold time.

The default value is 1s and the settable range is from 1ms to 50Ks.

6.8 Mark Frequency

When the output signal frequency is less than the specified mark frequency, there will output the low level signal from the **[FSK/Trig/Sync/Extmod]** connector on the rear panel. When the output signal frequency is at or greater than the specified mark frequency, the signal output on the **[FSK/Trig/Sync/Extmod]** connector will change from low level to high level.

When **[Sweep]** is enabled, press **Mark Frequency** softkey and use the numeric keyboard or the direction keys and knob to modify the mark frequency. The default value is 500Hz and the settable range is limited by the "Start Frequency" and "Stop Frequency".

6.9 Sweep Trigger Source

The sweep trigger source could be internal, external or manual. The generator will generate a sweep output when a trigger signal is received and then wait for the next trigger signal.

When **[Sweep]** is enabled, press **Trigger Sources** softkey to select **Internal**, **External** or **Manual**. The default is internal.

- ◆ **Internal:** The generator outputs continuous sweep waveform at a rate determined by the total of the specified sweep time, return time and hold time.
- ◆ **External:** The signal generator receives the trigger signal from the **[FSK/Trig/Sync/Extmod]** connector on the rear panel. A sweep will be generated once the connector gets a TTL pulse with specified polarity. To set the TTL pulse polarity, press **Polarity** to select "Positive" or "Negative". The default is "Positive".
- ◆ **Manual:** A sweep will be generated from the corresponding channel once you press **[Trigger]** at the front panel.

6.10 Trigger Output Edge

In sweep mode, when "Internal" or "Manual" trigger source is selected, the generator will output a TTL compatible signal with specified edge from the **[FSK/Trig/Sync/Extmod]** connector on the rear panel.

Internal and Manual Trigger: The generator outputs a Pulse waveform from the **[FSK/Trig/Sync/Extmod]** connector on the rear panel at the beginning of the Sweep. The trigger period depends on the specified frequency sweep time, return time, and hold time. When the output signal frequency is less than the specified mark frequency, there will output the low

level signal from the **[FSK/Trig/Sync/Extmod]** connector on the rear panel. When the output signal frequency is at or greater than the specified mark frequency, the signal outputs on the [FSK/Trig/Sync/Extmod] connector will change from low level to high level.

External Trigger: The **[FSK/Trig/Sync/Extmod]** connector is used as the input terminal of external trigger signal and has no trigger output.

Chapter 7 Burst

The HDG3000B(C) can output a waveform for a specified number of cycles, called a burst. It supports control of burst output by internal, external or manual trigger source; supports three kinds of burst types including N cycle, Infinite cycle and Gated. Burst is allowed with sine, square, ramp, pulse, Harmonic, noise (allowed only in gated burst mode) or arbitrary waveforms (except DC).

- ◆ **Select Burst**
- ◆ **Burst Type**
- ◆ **Burst Count**
- ◆ **Burst Period**
- ◆ **Burst Phase**
- ◆ **Trigger Source**
- ◆ **Gate Polarity**
- ◆ **Trigger Output Edge**

7.1 SelectBurst

Press **[Burst]** button on the front panel to enable Burst function (the backlight of the key goes on), and **Mod** or **Sweep** function will be automatically disabled (if currently enabled).

To avoid multiple waveform changes, enable burst mode after configuring other parameters.

7.2 Burst Type

This instrument could output three types of bursts, including **N Cycle**, **Infinite Cycle** and **Gate**. The default is **N Cycle**.

Burst Type	Trigger Source	Carrier Waveform
N Cycle	Internal/External/Manual	Sine/Square/Ramp/Pulse/Harmonic/Arbitrary waveform (except DC)
Infinite	External/Manual	Sine/Square/Ramp/Pulse/Harmonic/Arbitrary waveform (except DC)
Gated	Ext	Sine/Square/Ramp/Pulse/Noise/Harmonic/Arbitrary waveform (except DC)

N Cycle Burst

In N Cycle mode, the generator will output waveform with specified number of cycles after receiving trigger signal.

Press **[Burst] >Type** softkey to select "N Cycle".

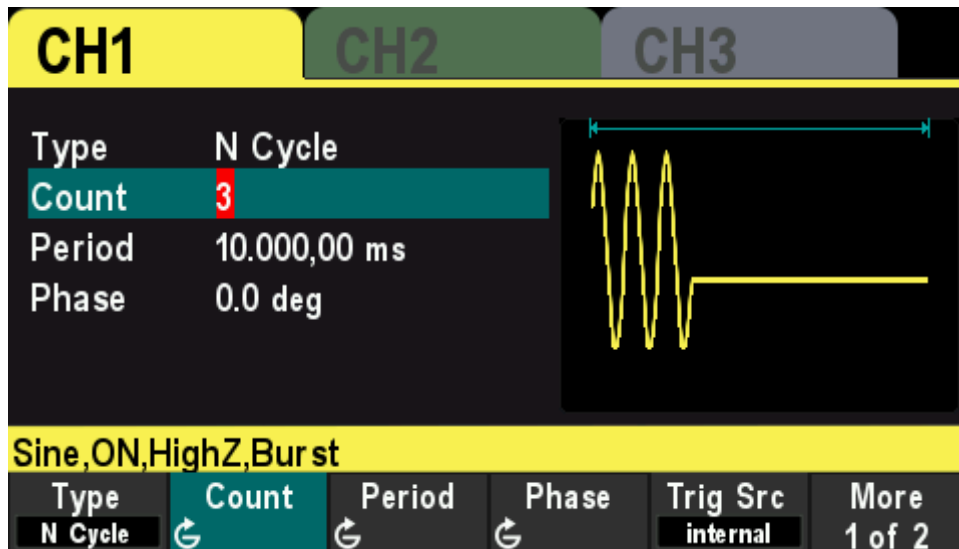

For N Cycle mode, the trigger source includes "Internal", "External" or "Manual". Besides, users can set the "Phase", "Count", "Burst Period" (internal trigger), "Trigger Slope" (external trigger) and "Trigger" (manual trigger).

Infinite CycleBurst

In Infinite Cycle mode, the cycle number of the waveform is set as an infinite value. The generator

outputs a continuous waveform after receiving trigger signal.

Press **[Burst] >Type** softkey to select “**Inf Cycle**”. A schematic diagram of infinite cycle pulse will be displayed on the screen.

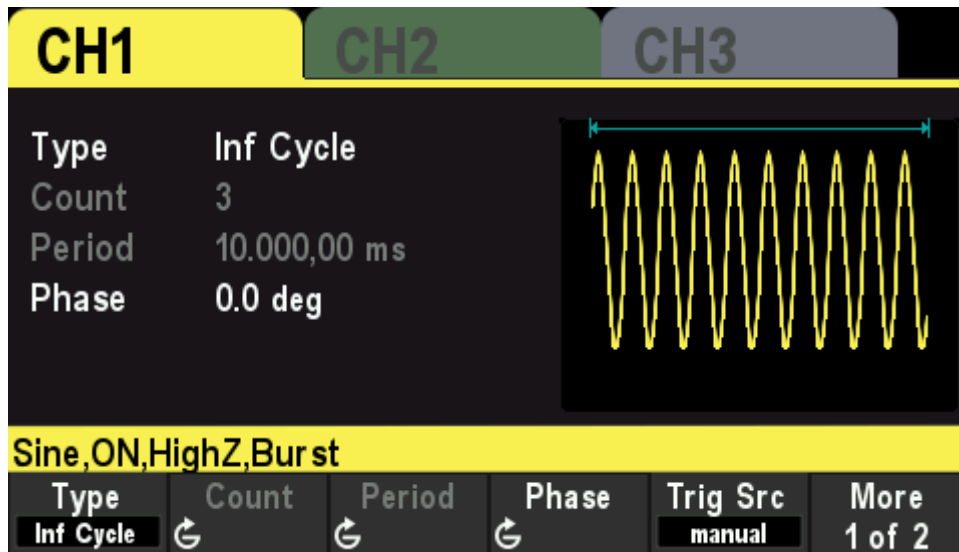

For Infinite Cycle mode, the trigger source includes "Internal", "External" or "Manual". Besides, users can set the "Phase", "Count" and "Trigger Slope" (external trigger) and "Trigger" (manual trigger).

GatedBurst

In Gated Mode, the generator controls the waveform output according to the external signal level from the **[FSK/Trig/Sync/Extmod]** connector on the rear panel.

Press **[Burst] >Type** softkey to select “**Gate**” and then press **Polarity** to set the gated polarity as "Positive" (or "Negative"). The generator outputs burst waveform only when the gated signal is "Positive" (or "Negative").

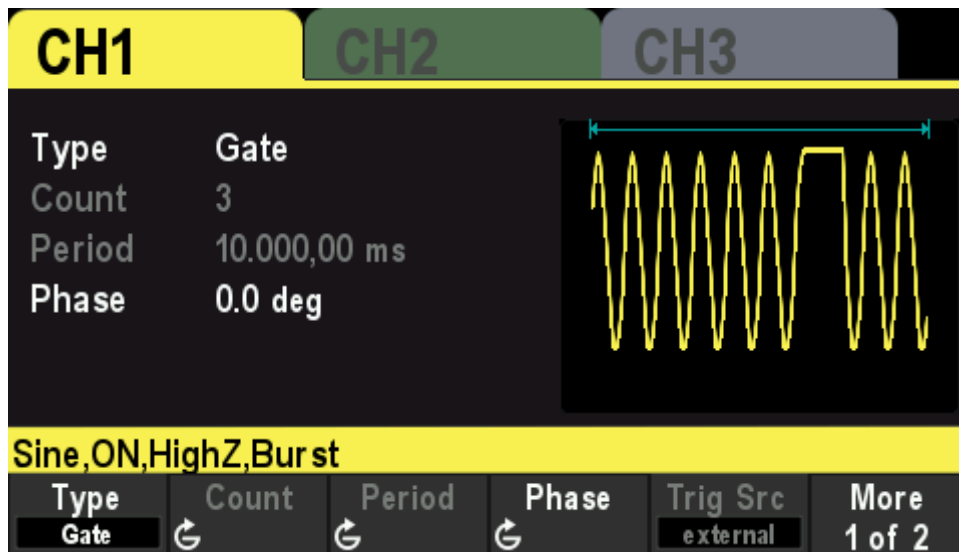

When the gated signal is "True", the generator outputs a continuous waveform; when the gated signal is "False", the generator completes the current period, and then stops and holds on the voltage level corresponding to the initial burst phase of the selected waveform. For Noise

waveform, the output will stop immediately once the gated signal becomes "False".

Gated Burst could only be triggered by External trigger source. In addition, users can set the "Phase".

7.3 BurstCount

Burst count is the number of carrier waveforms in one burst period. It is only available for N Cycle Burst mode (internal, external, or manually trigger sources).

◆ For internal trigger source, Burst period $\geq 1\mu\text{s} + \text{Carrier Waveform Period} \times \text{Burst Count}$. Press **[Burst] > Type** softkey to select "N Cycle". The "Count" parameter is highlighted and is editable. And use the numeric keypad or direction keys and the knob to input the desired count. The default is 1 and the settable range is 1 to 2000 000 000.

This menu will be grayed out and disabled when the burst type is set to Infinite cycle or Gated.

7.4 BurstPeriod

Burst period is the time from the start of one burst to the start of next burst. It is only available for N Cycle burst in internal trigger. The default is 10 ms.

- ◆ Burst period $\geq 1\mu\text{s} + \text{Carrier Waveform Period} \times \text{Burst Count}$.
- ◆ If the burst period is set to too small, the generator will increase this period automatically to allow the output of the specified number of cycles.

Press **[Burst] > Type** softkey to select **N Cycle**. Press **Trig Src** softkey and select **Internal**, then press **Periods** softkey, and use the numeric keypad or direction keys and the knob to input the desired period. The default value is 10ms and the settable range is $2\mu\text{s}$ to 500s.

This menu will be grayed out and disabled when the burst type is set to Infinite cycle or Gated.

7.5 BurstPhase

Burst phase is defined as the phase of the start point of the burst.

When **Burst** is enabled, press **Phase** softkey and use the numeric keypad or direction keys and the knob to input the desired phase. The default value is 0° and the settable range is 0° to 360° .

- ◆ For Sine, Square, Ramp and Pulse, 0° is the point where the waveform passes through 0V (or DC offset value) positively.
- ◆ For arbitrary waveform, 0° is the first point of the waveform.
- ◆ For Noise, **Start Phase** is unavailable.

7.6 Trigger Source

Burst trigger source could be internal, external or manual. The generator will generate a burst output when a trigger signal is received and then wait for the next trigger

When **Burst** is enabled, press **Trig Src** softkey to select "Internal", "External" or "Manual". The

default setting is "Internal".

Internal Trigger

When internal trigger is selected, the generator can only output N cycle burst and the burst frequency is determined by the "Burst Period".

External Trigger

When external trigger is selected, the generator can output N cycle, infinite or gated burst. The generator receives the trigger signal from the **[FSK/Trig/Sync/Extmod]** connector on the rear panel. A burst will be generated once the connector receives a TTL pulse with specified slope or polarity.

To set the external trigger slope, press **Slope** softkey to select "Rising" or "Falling" and the default is "Rising".

Manual trigger

When manual trigger is selected, the generator can output N cycle or infinite burst. A burst will be generated from the corresponding channel (if currently turned on) Once the **Trigger** button at the front panel is pressed. If the corresponding channel is not turned on, the trigger will be ignored.

7.7 GatePolarity

Gate polarity is only available in gated burst mode. The generator will output burst when the gated signal from the **[FSK/Trig/Sync/Extmod]** connector on the rear panel is "High Level" or "Low Level".

When **Burst** is enabled, press **Type** softkey to select "**Gate**" and press **Polarity** softkey to select "**Positive**" or "**Negative**". The default is "Positive".

7.8 Trigger Output Edge

In burst mode, when the trigger source is "Internal" or "Manual", the generator would output a TTL-compatible signal with specified edge from the **[FSK/Trig/Sync/Extmod]** connector on the rear panel.

- ◆ **Internal trigger:** The generator outputs a square waveform with variable duty cycle (related to the carrier period and number of cycles) from the **[FSK/Trig/Sync/Extmod]** connector at the start of the burst.
- ◆ **Manual trigger:** The generator outputs a pulse from the **[FSK/Trig/Sync/Extmod]** connector at the start of the burst.
- ◆ **External Trigger:** The **[FSK/Trig/Sync/Extmod]** connector is used as the input terminal of external trigger signal and has no trigger output.

Chapter 8 Counter

The generator provides a counter which can measure various parameters (such as frequency, period, duty cycle, positive pulse width and negative pulse width) of external input signal.

Press **[Utility] > Counter** softkey on the front panel to enable counter function. Input the signal to the **Counter** connector on the rear panel measure.

Press **Exit** softkey or any other key to exit the counter.

Press **Gate Time** softkey and use the direction keys and the knob to modify the current value.

The default value is 1s and the settable range is 10ms to 16s.

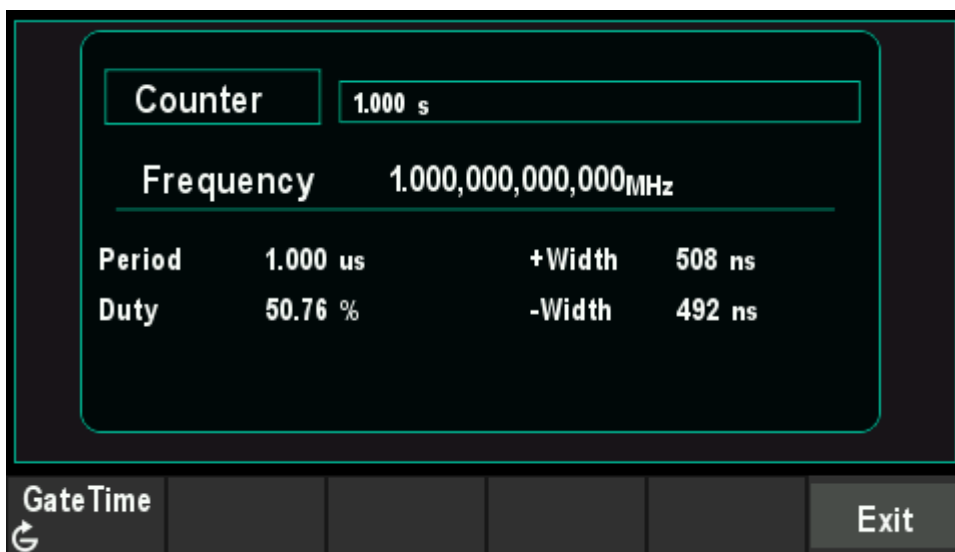

Chapter 9 Store

The instrument allows the user to store the current settings state of the instrument in internal or external storage and recall it when needed.

9.1 Store System

The instrument provides an internal memory (home disk) and an external memory (USB disk).

Home disk: Users can save the instrument settings state to this disk in .pho format. And the file also can be recalled.

USB disk: Available when the instrument detects external storage (front USB port). Users can save the instrument settings state to external storage in .pho format. The state files .pho and arbitrary waveform files .hwf in the external memory can be recalled.

The instrument settings state file includes waveform basic parameters, Mod/Sweep/Burst parameters and counter parameters.

Press **[Utility] > Store** softkey to open the store interface, as shown in the figure below.

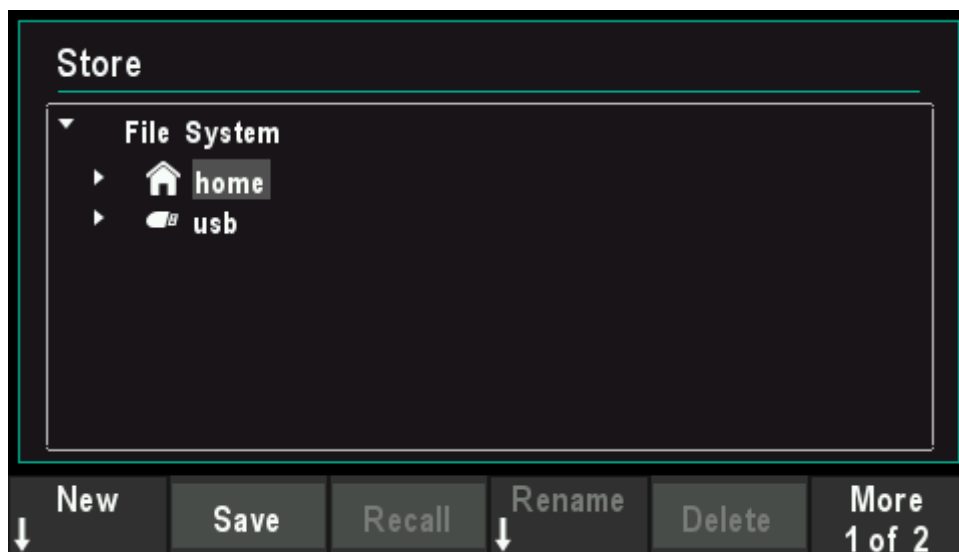

Note: The instrument can only identify filenames consist of English letters, number and underscore. If other characters are used to name the file or folder, the name might be displayed in the store and recall interface abnormally.

9.2 File Operation

Press **[Utility] > Store** softkey to enter File System, users can perform a series of operations on files or directories including New, Save, Recall, Rename, Delete, and Refresh.

New File

In Store interface, rotate the knob to select **home** disk or **usb** disk, and then press **New** softkey to enter the filename editing interface, as shown in the figure below.

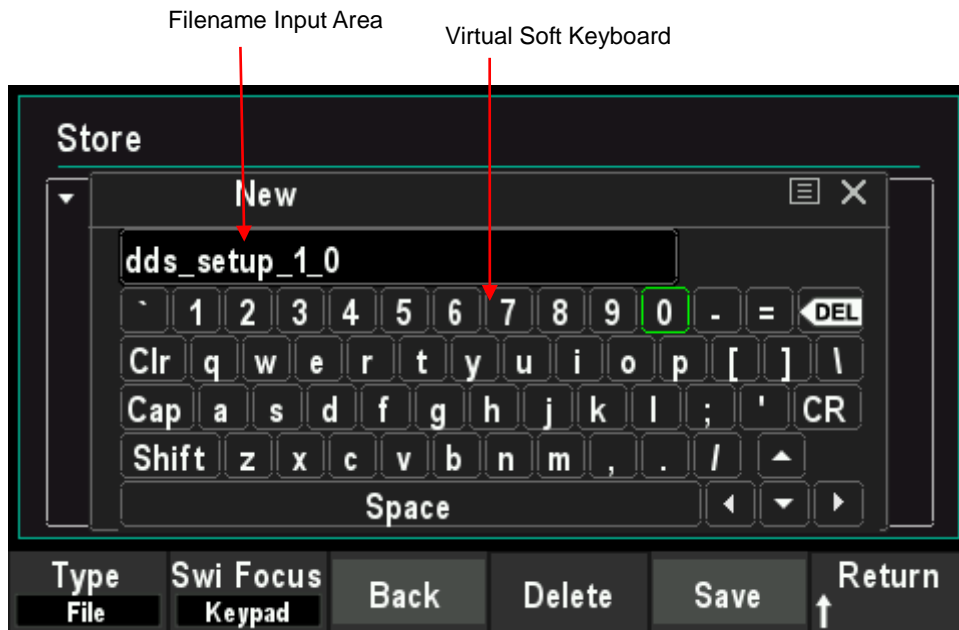

1. Press **Type** softkey to select "File".
File: Create a new state file.
Directory: Create a new directory.
2. Press **Switch Focus** softkey and select Name or Keypad.
Name: Put the cursor in the Filename Input Area. Use direction keys to move the cursor position and specify the location of the modified character.
Keypad: Put the cursor in the Virtual Keyboard. Rotate the knob to move the cursor position and press down the knob to input the character. In the virtual keyboard, rotate the knob to select **Caps** and press down to switch between uppercase and lowercase; rotate the knob to select **Shift** and press down to switch some symbols.
3. Press **Backspace** softkey to remove the characters in front of the cursor one by one.
4. Press **Delete** softkey to delete all the characters in the Filename Input Area.
5. After entering the file name in the Filename Input Area, press **Save** softkey to save the state file.
6. Press **Return** softkey to exit the **New** menu and return to the previous menu.

Save

Press **Save** softkey to automatically create a new state file and save it.

Recall

Press **Recall** softkey to recall the state file or arbitrary waveform file.

Rename

Use the knob to select the specified file or directory and press **Rename** softkey to rename. Refer to the operation method of creating a new file. After the completion of the denomination, press **Confirm** softkey to confirm the change.



Delete

Use the knob to select the specified file or directory and press **Delete** softkey to delete the selected file or directory.

Refresh

Press **Refresh** softkey to refresh the file list.

Chapter 10 Utility

The signal generator allows the user to configure channel parameters, configure remote interfaces, and set system parameters.

- ◆ **Sync**
- ◆ **Impedance Settings**
- ◆ **System Settings**
- ◆ **Firmware Update**

10.1 Sync

The synchronous signal is output from the **[FSK/Trig/Sync/Extmod]** connector on the rear panel. The instrument could output the sync signals of basic waveforms (except Noise), arbitrary waveforms (except DC), Harmonics, Sweep, Burst and Modulation from a single channel or two channels at the same time.

- ◆ The sync signal is a squarewaveform that is "high" in the first half of the cycle and "low" in the second half. When sync signal is disabled, the output level at the **[FSK/Trig/Sync/Extmod]** connector is logic low.
- ◆ The amplitude of Sync signal is not adjustable and is fixed at TTL level.

Sync Signals of Various Waveforms

- ◆ For Sine, Square, Ramp, and Pulse, the sync signal is a Square with 50% duty cycle. When the first wave point is output, the synchronization signal is TTL high level. When the frequency of the basic waveform is less than or equal to 30 MHz, the sync signal has the same frequency as the basic waveform. When the frequency of the basic waveform is greater than 30 MHz, the frequency of the sync signal is (the basic waveform frequency $\div 2^n$). Wherein, n represents the frequency dividing coefficient, and it is 1 when the frequency of the basic waveform is greater than 30 MHz and less than or equal to 60 MHz, and it is 2 when the frequency of the basic waveform is greater than 60 MHz and less than or equal to 90 MHz.
- ◆ For noise, there is no sync signal output.
- ◆ For arbitrary waveform, the sync signal is a square with 50% duty cycle. When the first wave point is output, the sync is TTL high level. The frequency of the sync signal is the frequency of arbitrary waveform.
- ◆ For harmonics, the sync signal is a square with 50% duty cycle. When the first waveform point is output, the sync signal is TTL high level. The frequency of the sync signal is the frequency of the basic wave.
- ◆ For AM, DSB-AM, FM, PM and PWM modulation, when internal modulation source is selected, the sync signal is a square with 50% duty cycle and takes modulating frequency as reference. When the first waveform point is output, the sync signal is TTL high level. When external modulation source is selected, there is no sync signal output.
- ◆ For ASK, FSK, PSK, BPSK, QPSK, 3FSK, 4FSK, OSK modulation, the sync signal is a square with 50% duty cycle and takes the modulating rate as reference. For ASK, FSK, PSK, OSK modulation, when external modulation is selected, there is no sync signal output.
- ◆ For Sweep, when the frequency of the sweep signal is less than the mark frequency, the sync signal is a TTL low level. When the frequency of the sweep signal is at or greater than the mark frequency, the sync signal is changed from TTL low level to TTL high level.
- ◆ For N-cycle burst, when internal or manual are selected as the trigger source, the sync signal is TTL high level at the start of the burst. At the end of the specified count of cycles, the sync signal is TTL low level (it may not be zero intersection if the waveform has an associated starting phase). For an infinite-cycle burst, when manual triggered is selected, the sync signal is the same as that of the basic waveform. For all burst types, when external trigger is

selected, there is no sync signal output.

10.2 Impedance Settings

The Impedance setting affects the output amplitude and DC offset voltage. For the front panel [1] connector, the HDG3000B(C) has a fixed series output impedance of 50Ω. If the actual load is different from the specified value, then the displayed voltage level will not match the voltage level of the components under test. To ensure the correct voltage level, ensure that the load impedance setting must match the actual load.

Press [Utility] > CH1 Set > Impedance softkey to choose HighZ or 50Ω. The default setting is HighZ. Impedance settings will be displayed on the screen. As shown in the figure below, the impedance of CH1 is set to "HighZ".

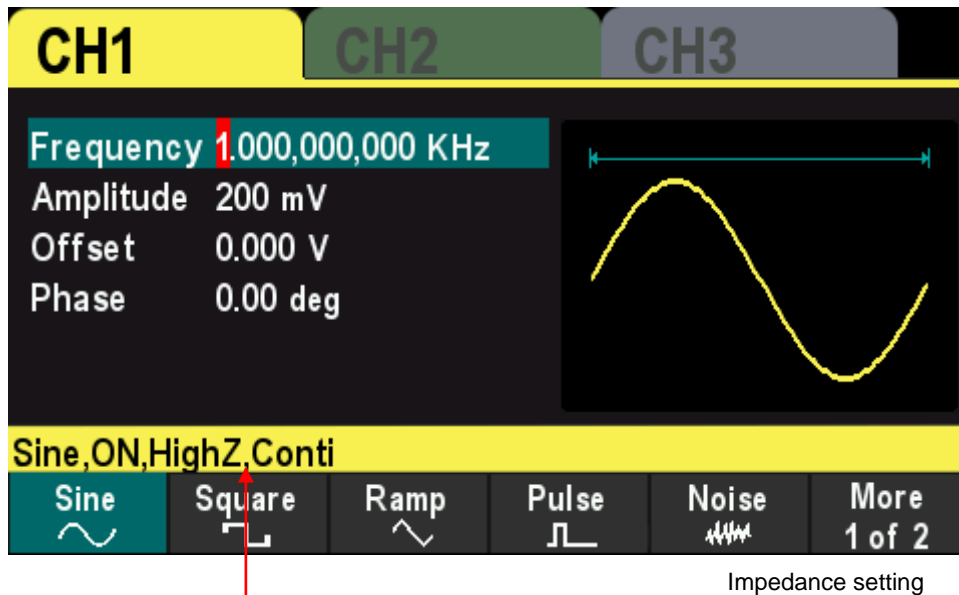

The generator will adjust the output amplitude and offset voltage automatically once the impedance setting is changed. For example, the current amplitude is 5Vpp and the output impedance is 50Ω. At this point, change the output impedance to HighZ and the amplitude displayed on the screen will double to 10Vpp. And the current amplitude is 5Vpp and the output impedance is HighZ. At this point, change the impedance to 50Ω, the amplitude will reduce to half of the previous value (2.5Vpp).

Note: Only the displayed values change with the parameter and the real output from the generator does not change.

10.3 System Settings

10.3.1 Language

The signal generator supports Chinese and English menu, and provides corresponding help information, prompt information and interface display.

Press **[Utility] > Language** softkey to select the desired language. When "Chinese" or "English" is selected, the menu, help message, prompt message, and interface are displayed in Chinese or English, respectively.

The language is not changed when the **[P]** key is pressed to restore the default settings.

10.3.2 Clock Source

The instrument provides an internal 10MHz clock source and can receive the external clock source from the **10MHz In/Out** connector at the real panel. It can also output the internal clock source from the **10MHz In/Out** connector for other devices.

Press **Utility > Clock Source** softkey to select "Internal" or "External". The default is "Internal". If "External" is selected, the instrument will detect whether a valid external clock signal is input from the **10MHz In/Out** connector at the real panel. If no valid clock source is detected, the prompt message "No valid 10MHz External Clock is detected" would be displayed and the clock source would be switched to "Internal".

Users can also synchronize two or more instruments by setting the clock source. When two instruments are synchronized, the SYNC of phase cannot be used. The SYNC of phase can only be used to adjust the phase relation between two output channels of the same instrument and cannot be used to change the phase relation between the output channels of two instruments. Users can change the phase relation between two instruments by change the "Start Phase" of each channel.

Sync methods for two or more instruments:

- ◆ Synchronization between two instruments:
Connect the **10MHz In/Out** connector of Generator A (set the clock source to "Internal") to the **10MHz In/Out** connector of Generator B (set the clock source to "External") and set the output frequencies of the two instruments as a same value to realize the synchronization between the two instruments.

- ◆ Synchronization among multi-instruments:
Divide the 10MHz clock source of a generator (set the clock source to "Internal") into multiple paths; then, connect them to the **10MHz In/Out** connectors of the other generators (set the clock source to "External") respectively. Finally, set the output frequencies of all the generators as a same value to realize the synchronization among multi-instruments.

10.3.3 Power On Settings

Set the configuration to be used when the instrument is powered on the next time to **Default**, **Last** or **Output off**. The default setting is "Default".

- ◆ **Default:** Denote the factory default settings except some parameters (such as: Language).
- ◆ **Last:** Include all the system parameters and output configuration, except clock source.
- ◆ **Output off:** The last setting will be used and all output will be closed.

Press [**Utility**]>**Startup** softkey to select the desired configuration type.

When [**P**] key is pressed to restore the default settings, this setting will not be affected.

10.3.4 Intensity

Press [**Utility**] >**Intensity** softkey and use the direction keys and the knob to change the backlight intensity of the screen.

The ranges from 1% to 100%.

10.3.5 System Information

Press [**Utility**] >**System Information** softkey to view the information of the device (such as model, serial number, version number, etc.).

10.3.6 Unit

Press [**Utility**] >**Unit** softkey to select units of waveform parameters.

Frequency/Period - Select the period or frequency as the waveform parameter that can be set.

Amplitude/high level - Select the amplitude or high level as the waveform parameter that can be set.

Offset/Low Level - Select the offset or low level as the waveform parameter that can be set.

Pulse width/duty cycle - Select the pulse width or duty cycle as the pulse parameters that can be set.

10.3.7 Save Picture

Users can store the content displayed on the screen in an external storage device in the form of pictures.

First, please connect the USB stick (FAT32 format, storage space is less than or equal to 32G) and insert the USB stick into the USB port on the front panel of the instrument. After successful connection, the corresponding prompt message pops up on the screen.

Then enter the interface that you need to save, and press **[Utility]** button, the instrument completes the screenshot and enters the Utility menu. At this time, the signal generator has cached the screenshot inside the instrument. Press **SavePic** softkey, and the instrument will save the screenshot to the USB stick.

Note: The screenshot cached is always the screen at the last time the **[Utility]** button was pressed.

10.4 Firmware Update

Copy the firmware to a USB stick (FAT32 format, storage space is less than or equal to 32GB) and insert the USB stick into the USB port on the front panel of the instrument.

Press **[Utility]** > **Update** softkey, enter the file browser interface, use the knob to select the firmware file, press **Recall** softkey to specify the file, and then press **OK** softkey to start the firmware update.

Chapter 11 Remote Control

The HDG3000B(C) can be controlled remotely through the following two methods.

Use PC software

Users can use the PC software to send commands to remotely control the instrument. You can download the software from our official website.

User-defined programming

Users can program and control the instrument by using the SCPI (Standard Commands for Programmable Instruments) commands. For more information about the commands and programming, refer to the SCPI protocol manual.

HDG3000B(C) can communicate with PC through USB. This chapter will give a detailed introduction of how to use software to control HDG3000B(C) remotely through the real USB port.

- ◆ Install Keysight IO libraries suite
- ◆ Remote Control via USB

11.1 Install Keysight IO libraries suite

Users can download the application software package on the official website of Hantek:

<http://hantek.com/products/detail/17187>

Or click the following website to download latest one:

<http://www.keysight.com/main/software.aspx?ckey=2175637&id=2175637&nid=-11143.0.00&lc=eng&cc=GB>

Double click the icon to start installing.

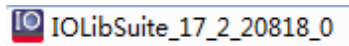

Click 'Next' to continue.

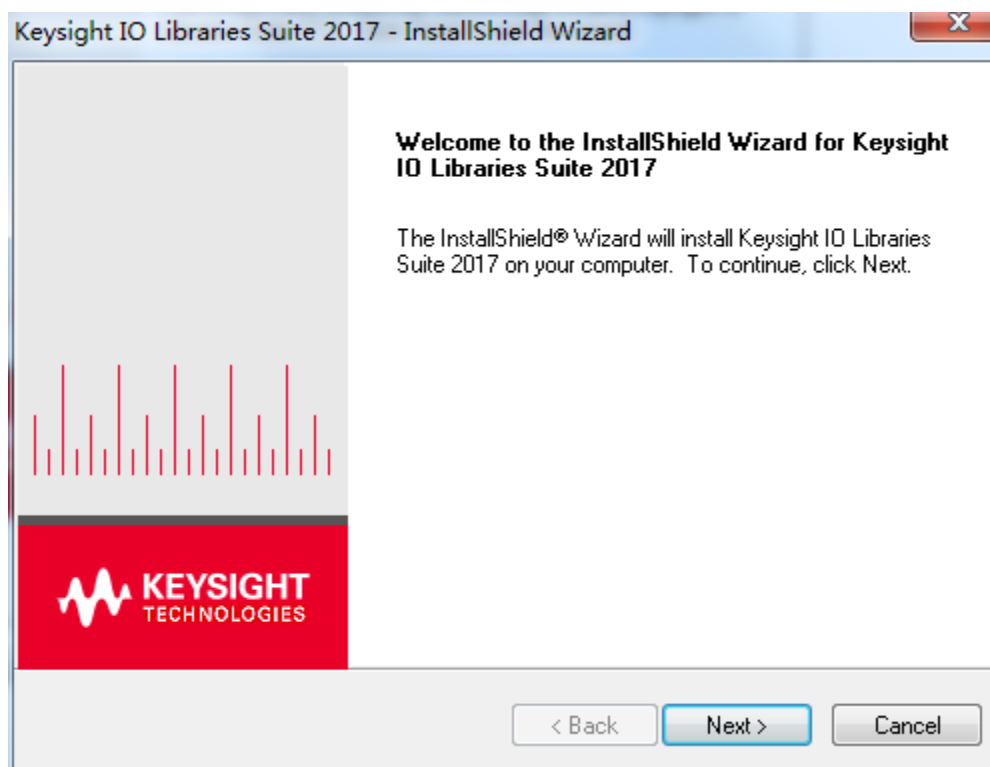

Read License Agreement and accept. Click 'Next' to continue.

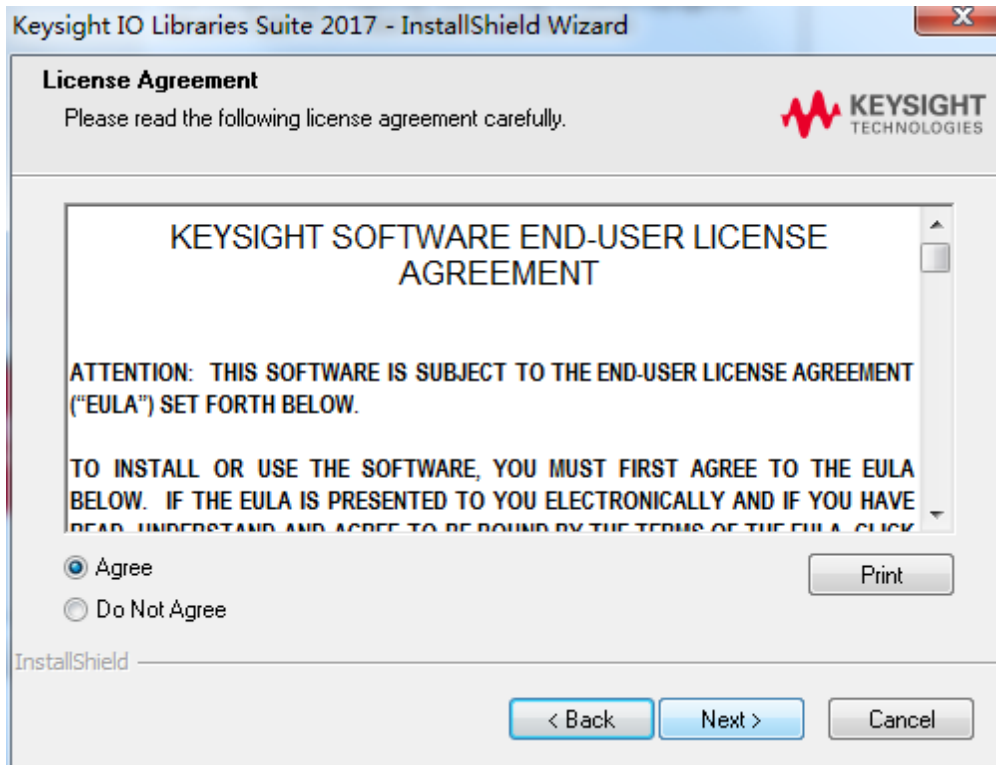

Select a Typical and click 'Next' to continue.

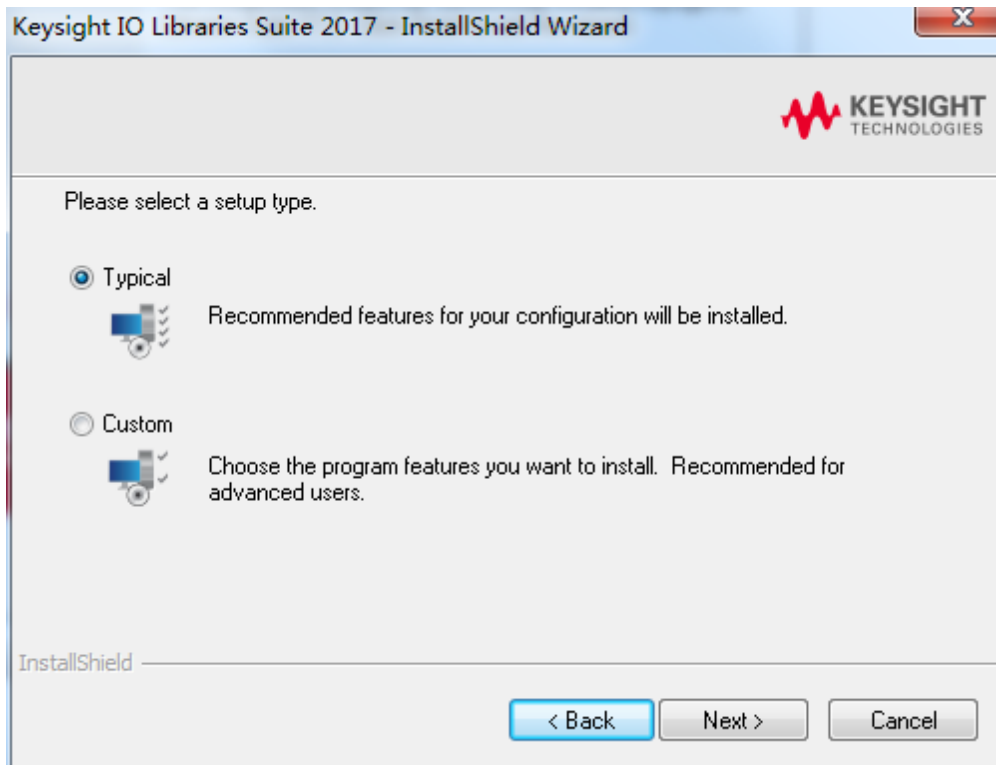

Or select a Custom and click 'Next' to continue.

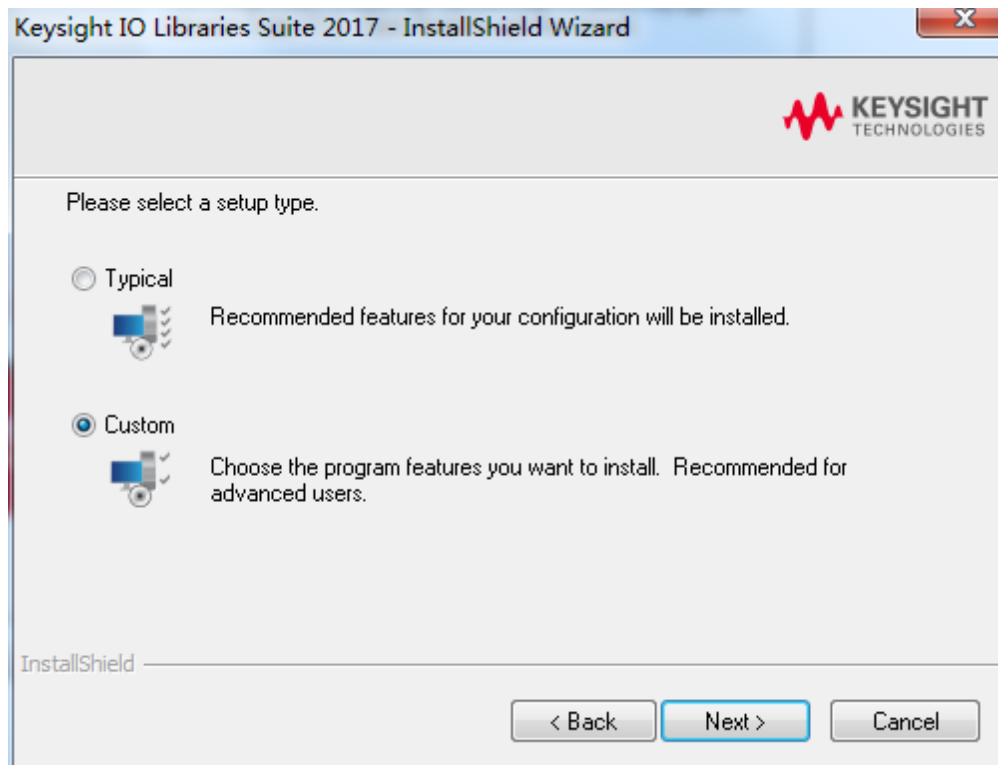

Select "Install Keysight VISA as primary VISA" and click 'Next' to continue.

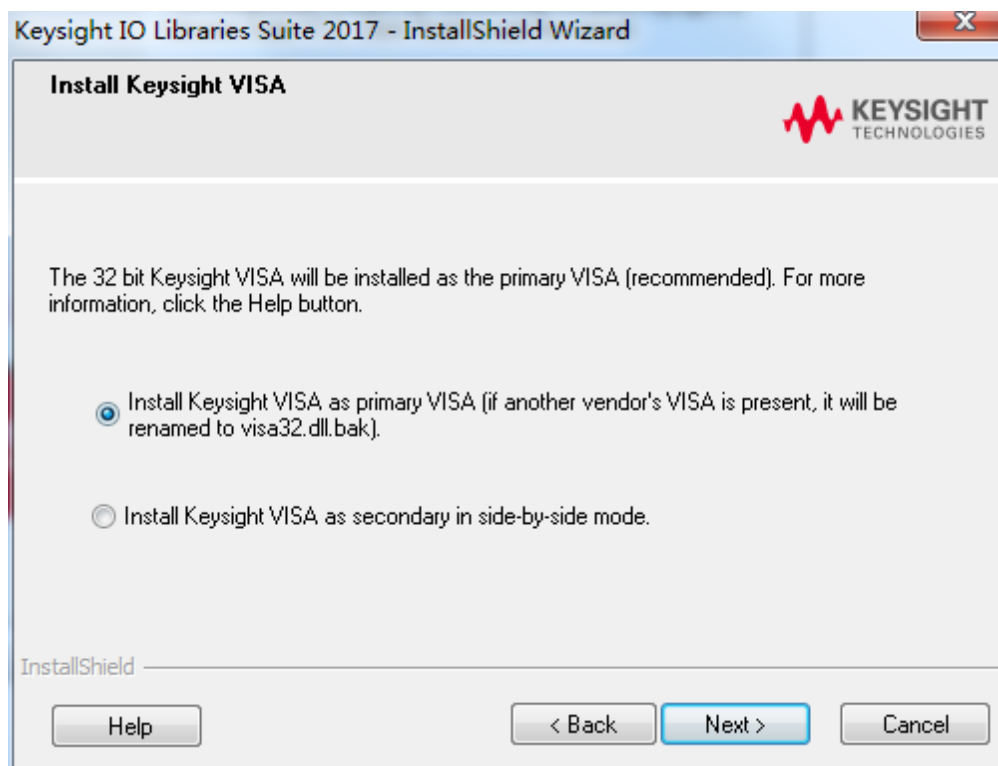

Click 'Install' to start copying files.

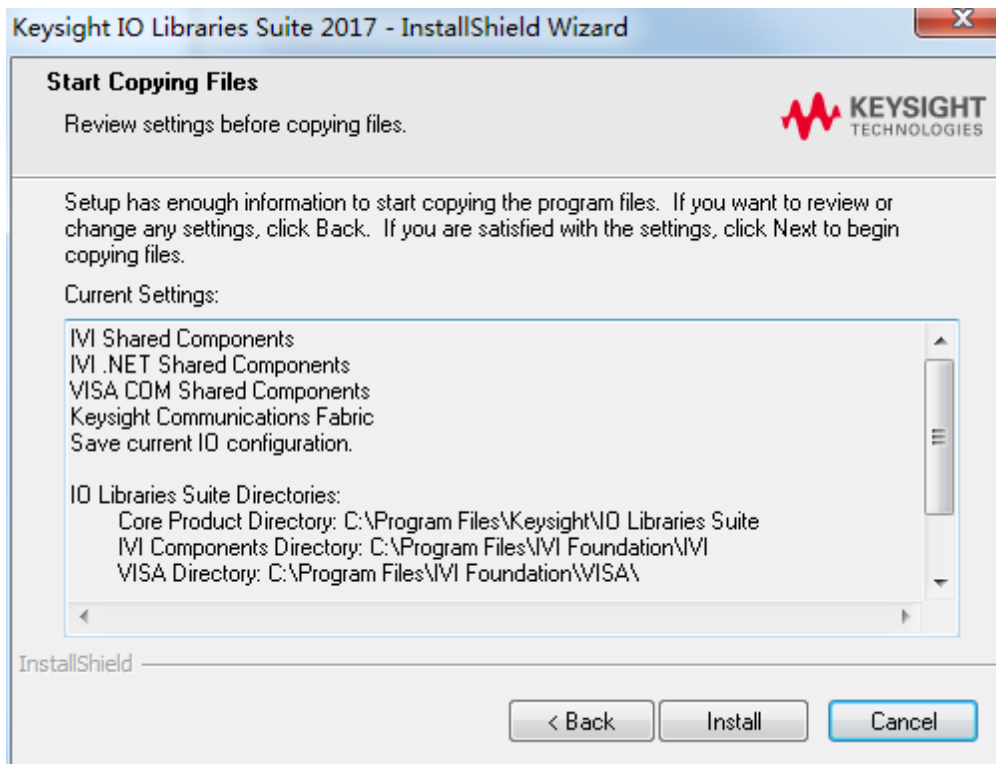

The installation is completed automatically. You will see the running IO program in the lower right corner of the screen.

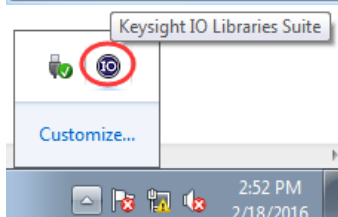
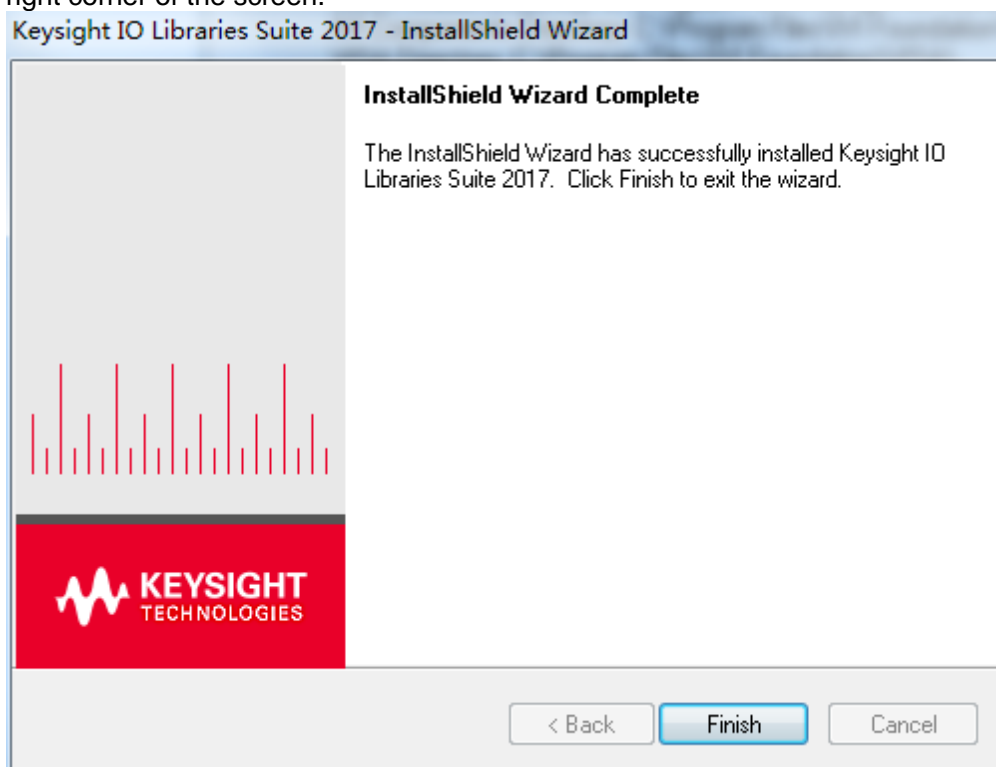

11.2 Remote Control via USB

1. Connect the device

Connect the instrument with your PC using a USB cable.

2. Search for device resource

Start up Keysight IO and the software will automatically search for the instrument resource currently connected to the PC. You can also click **Rescan** to search for the resources.

3. View the device resource

The resource found will appear under the directory, and the model number and USB interface information of the instrument will also be displayed.

For example, HDG3102C(USB0::0x0483::0x5740::*****:0::INSTR)

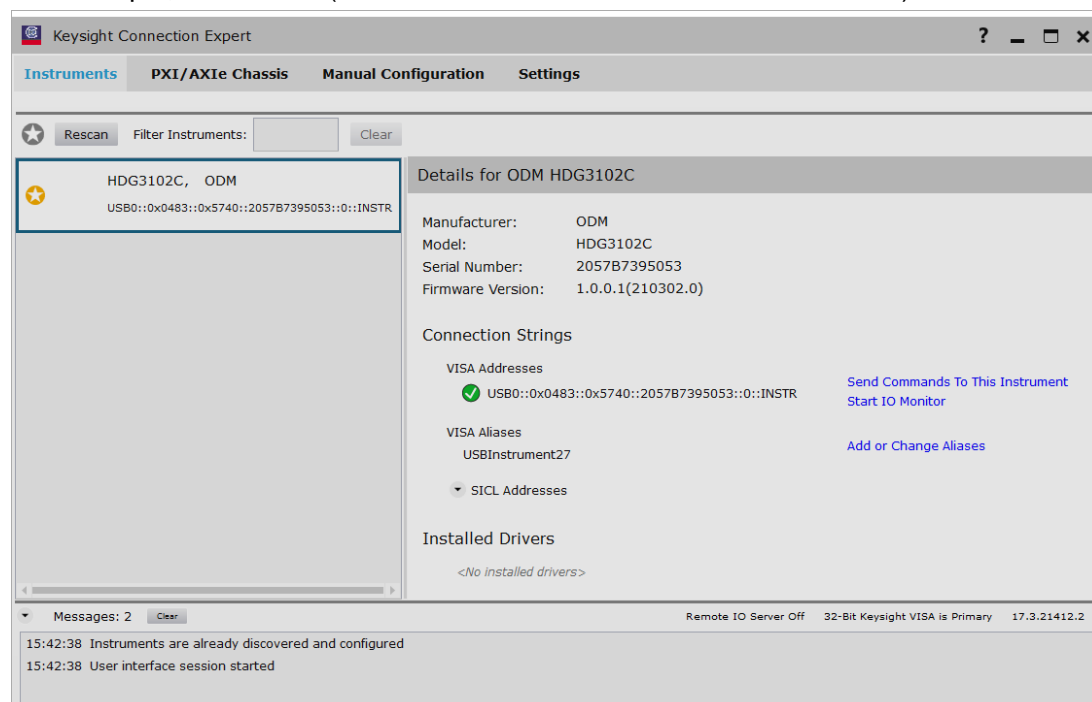

4. Control the instrument remotely

1) Use PC software

Users can download the application software package on the official website of Hantek:

<http://hantek.com/products/detail/17187>

Double-click the Setup.exe file and install it according to the installation wizard.

After the installation is complete, the software icon will be displayed on the computer desktop.



Double click the software icon on the desktop after you finished the software setting and equipment connecting. Then a user interface will be showed as follows:

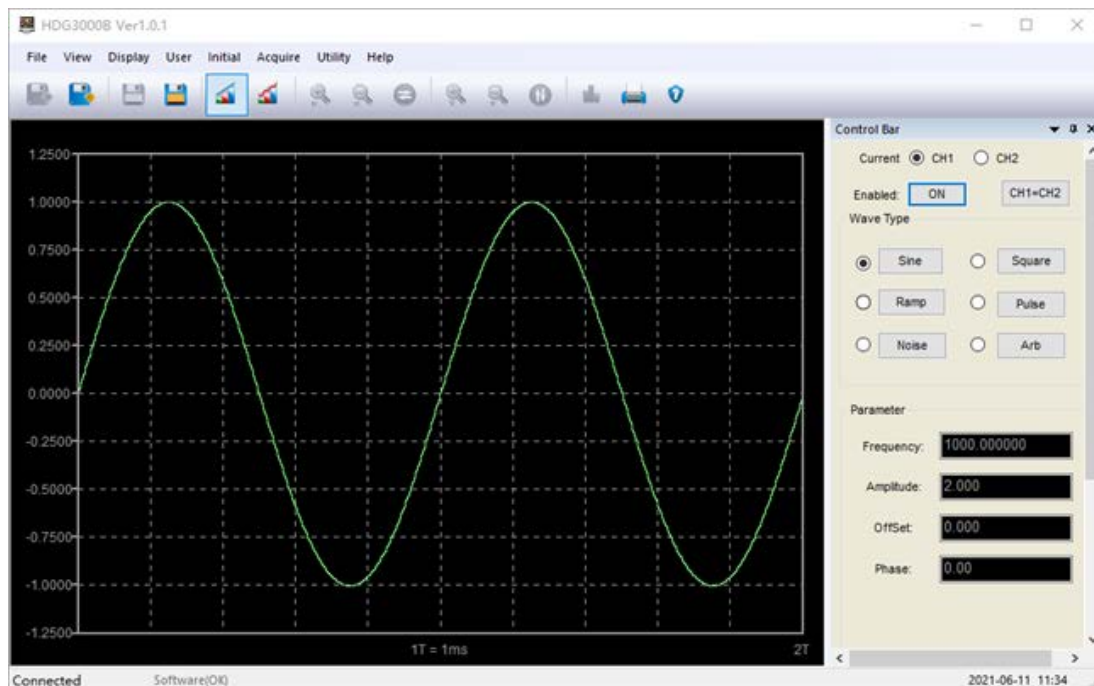

2) User-defined programming

Start up Keysight IO and the software will automatically search for the instrument resource currently connected to the PC.

Click “Send Commands To This Instrument” to open Keysight interactive IO interface. You can send commands and read data.

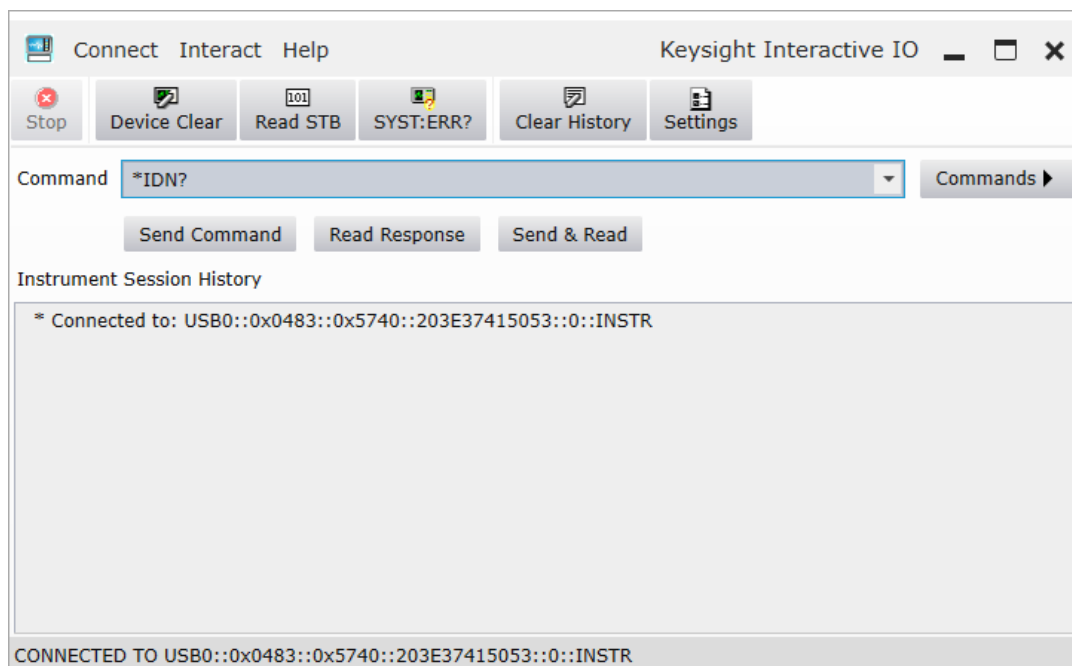

For more information about the commands and programming, refer to the SCPI protocol manual.

Appendix A Specifications

All technical specifications are suitable for HDG3000B(C) series signal generators. Unless otherwise stated, all technical specifications are guaranteed upon the following two conditions.

- ◆ The signal generator is in the calibration period.
- ◆ The signal generator has operated continuously for more than 30 minutes at the specified operating temperature (18°C to 28°C).

All specifications used are guaranteed, except those marked "Typical".

Model	HDG3102B	HDG3082B	HDG3062B	HDG3042B	HDG3022B	HDG3012B
Channel	2					
Memory Depth	2M					
Maximum Frequency	100MHz	80MHz	60MHz	40MHz	25MHz	15MHz
Sampling Rate	300MSa/s					
Voltage Resolution	16Bit					
Waveforms						
Standard Waveforms	Sine, Square, Ramp, Pulse, Noise, Harmonic, DC					
Arbitrary Waveforms	More than 160 kinds, including Sinc, Exponential Rise, Exponential Fall, ECG, Gauss, Haver Sine, Lorentz, Dual-Tone, etc.					
Frequency Characteristics						
Sine	1uHz~100MHz	1uHz~80MHz	1uHz~60MHz	1uHz~40MHz	1uHz~25MHz	1uHz~15MHz
Square	1uHz~15MHz	1uHz~15MHz	1uHz~15MHz	1uHz~15MHz	1uHz~15MHz	1uHz~15MHz
Pulse	1uHz~15MHz	1uHz~15MHz	1uHz~15MHz	1uHz~15MHz	1uHz~15MHz	1uHz~15MHz
Ramp	1uHz~2MHz	1uHz~2MHz	1uHz~2MHz	1uHz~2MHz	1uHz~2MHz	1uHz~2MHz
Harmonic	1uHz~50MHz	1uHz~40MHz	1uHz~30MHz	1uHz~20MHz	1uHz~10MHz	1uHz~5MHz
Noise (-3dB)	100 MHz bandwidth					
Arbitrary	1uHz~20MHz	1uHz~20MHz	1uHz~20MHz	1uHz~15MHz	1uHz~15MHz	1uHz~15MHz
Resolution	1uHz					
Accuracy	±1ppm, 18 ~ 28 °C					
Square Characteristics						
Rise/Fall time	Typical (1kHz, 1Vpp) ≤9ns					
Overshoot	Typical (100kHz, 1Vpp) ≤5%					
Duty Cycle	0.001%~99.999%; Range varies with frequency					
Non-symmetry	1% of the period + 4ns					

Ramp Characteristics						
Linearity	≤ 1% of peak output (typical, 1kHz, 1Vpp, symmetry 100%)					
Symmetry	0% ~ 100%					
Pulse Characteristics						
Period	67ns~1Ms	67ns~1Ms	67ns~1Ms	67ns~1Ms	67ns~1Ms	67ns~1Ms
Pulse	≥16ns					
Duty Cycle	0.001%~99.999%; Range varies with frequency					
Rise/Fall time	≥9ns					
Overshoot	Typical (1kHz, 1Vpp) ≤5%					
Arbitrary Waveform Generator						
Waveform Length	2M					
Vertical Resolution	16 Bits					
Sampling Rate	1uSa/s~ 75MSa /s, 1uSa /s resolution					
Rise/Fall time	≥9ns					
Overshoot	Typical (1Vpp) ≤5%					
Harmonic Characteristics						
Harmonic order	≤16					
Harmonic type	Even, Odd, All					
The harmonic amplitude	can be set for all harmonics					
Harmonic phase	can be set for all harmonics					
Amplitude Characteristics (50Ω terminal)						
Amplitude Range	≤10MHz: 1mVpp ~ 10Vpp; ≤55MHz: 1mVpp ~ 5.5Vpp; ≤80MHz: 1mVpp ~ 3.5Vpp; ≤100MHz: 1mVpp ~ 2Vpp;					
Accuracy	Typical (1kHz Sine, 0V offset, > 10mVpp) ±1% of setting value ± 5mVpp					
Amplitude flatness (relative to 1kHz Sine, 3.5Vpp, 50Ω)	≤5MHz: ±0.1dB; ≤15MHz: ±0.2dB; ≤25MHz: ±0.3dB ≤40MHz: ±0.5dB ≤100MHz: ±1.0dB					

Unit	Vpp, mVpp, Vrms, dBm (50Ω terminal)
Resolution	1mVpp
Offset Characteristics (50Ω terminal)	
Range	±5Vpkac+dc
Accuracy	±(1% of setting value + 5mV + 1% of amplitude)
Waveform Output	
Impedance	50Ω
Modulation Characteristics	
Modulation Type	AM, DSB-AM, FM, PM, ASK, FSK, PSK, BPSK, QPSK, 3FSK, 4FSK, OSK, PWM
AM	
Carrier Waveforms	Sine, Square, Ramp, Pluse, Harmonic, Arb. (except DC)
Modulation Source	Internal, External, another channel
Modulation Waveforms	Sine, Square, Ramp, Noise, Sinc, Exp Fall, Haver Sine, Lorentz, Gause, Dual Tone, ECG
Modulation Frequency	2mHz~1MHz
Modulation Depth	0% ~ 120%
DSB-AM	
Carrier Waveforms	Sine, Square, Ramp, Pluse, Harmonic, Arb. (except DC)
Modulation Source	Internal, External, another channel
Modulation Waveforms	Sine, Square, Ramp, Noise, Sinc, Exp Fall, Haver Sine, Lorentz, Gause, Dual Tone, ECG
Modulation Frequency	2mHz~1MHz
Modulation Depth	0% ~ 120%
FM	
Carrier Waveforms	Sine, Square, Ramp, Pluse, Harmonic, Arb. (except DC)
Modulation Source	Internal, External, another channel
Modulation Waveforms	Sine, Square, Ramp, Noise, Sinc, Exp Fall, Haver Sine, Lorentz, Gause, Dual Tone, ECG
Modulation	2mHz~1MHz

Frequency	
PM	
Carrier Waveforms	Sine, Square, Ramp, Pluse, Harmonic, Arb. (except DC)
Modulation Source	Internal, External, another channel
Modulation Waveforms	Sine, Square, Ramp, Noise, Sinc, Exp Fall, Haver Sine, Lorentz, Gause, Dual Tone, ECG
Modulation Frequency	2mHz~1MHz
Phase Deviation	0 ° ~ 360 °
ASK	
Carrier Waveforms	Sine, Square, Ramp, Pluse, Harmonic, Arb. (except DC)
Modulation Source	Internal, External
Modulation Waveforms	Square with 50% duty cycle
Rate	2mHz~1MHz
FSK	
Carrier Waveforms	Sine, Square, Ramp, Pluse, Harmonic, Arb. (except DC)
Modulation Source	Internal, External
Modulation Waveforms	Square with 50% duty cycle
Rate	2mHz~1MHz
PSK	
Carrier Waveforms	Sine, Square, Ramp, Pluse, Harmonic, Arb. (except DC)
Modulation Source	Internal, External
Modulation Waveforms	Square with 50% duty cycle
Rate	2mHz~1MHz
BPSK	
Carrier Waveforms	Sine, Square, Ramp, Pluse, Harmonic, Arb. (except DC)
Modulation Data Source	PN15, PN21, 01, 10

Rate	2mHz~1MHz
QPSK	
Carrier Waveform	Sine, Square, Ramp, Pluse, Harmonic, Arb. (except DC)
Modulation Data Source	PN15, PN21
Rate	2mHz~1MHz
3FSK	
Carrier Waveform	Sine, Square, Ramp, Pluse, Harmonic, Arb. (except DC)
Modulation Source	Internal
Modulation Waveforms	50% duty cycle square wave
Rate	2mHz~1MHz
4FSK	
Carrier Waveform	Sine, Square, Ramp, Pluse, Harmonic, Arb. (except DC)
Modulation Source	Internal
Modulation Waveforms	50% duty cycle square wave
Rate	2mHz~1MHz
OSK	
Carrier Waveform	Sine
Modulation Source	Internal, external
OSC Time	8 ns - 4.99975 ms
Rate	2mHz~1MHz
PWM	
Carrier Waveform	Square
Modulation Source	Internal, external and another channel
Modulation Waveforms	Sine, Square, Ramp, Noise, Sinc, Exp Fall, Haver Sine, Lorentz, Gause, Dual Tone, ECG
Modulation Frequency	2mHz~50KHz
Duty Deviation	0.1% ~ 49.9%
External Modulation Input	

Input Range	AM, DSB-AM, FM, PM, OSK, PWM: 75MVRMS ~ ± 5VAC + DC ASK, FSK, PSK: TTL level
Input Bandwidth	50KHz
Input Impedance	10kΩ

Sweep Characteristics

Carrier Waveform	Sine, Square, Ramp, Pluse, Harmonic, Arb. (except DC)
Type	Linear
Type Direction	Up
Sweep Time	1ms ~ 50Ks
Hold/Return Time	1ms ~ 50Ks
Trigger Source	Internal, External, Manual
Mark	Falling Edge of Sync signal

Burst Characteristics

Carrier Waveform	Sine, Square, Ramp, Pluse, Harmonic, Arb. (except DC)					
Carrier Frequency	1uHz~100MHz	1uHz~80MHz	1uHz~60MHz	1uHz~40MHz	1uHz~25MHz	1uHz~15MHz
Burst Count	1 ~ 2000 000 000					
Start/Stop Phase	0° ~ 360°					
Internal Period	2μs ~ 500s					
Gated Source	External trigger					
Trigger Source	Internal, External or Manual					

Counter

Function	Frequency, Period, Positive/Negative Pulse Width, Duty Cycle
Frequency	1uHz ~ 80MHz
Gate time	10ms ~ 16s
Level	0 ~ 3.3V

Trigger Characteristics

Trigger Input	
Level	TTL - compatible
Slope	Rising or falling (selectable)

Pulse width	>100ns
Trigger Output	
Level	TTL - compatible
Pulse Width	>60ns
Maximum Rate	1MHz

Clock Reference

External Reference Input

Lock Range	10 MHz + 50 Hz
Level	Low level: 0~400mV, high level: 2.5V~ 5V
Locking Time	<2s
Impedance	50Ω, DC coupling

Internal Reference Output

Frequency	10 MHz + 50 Hz
Level	3.3 Vpp
Impedance (typical)	50Ω, DC coupling

Sync Output

Level	TTL - compatible
Impedance	50Ω, nominal value

CH3 Output (HDG3000C series only)

Standard Waveforms	Sine, Square, Ramp, Noise, Harmonic, DC
Arbitrary Waveforms	More than 160 kinds, including Sinc, Exponential Rise, Exponential Fall, ECG, Gauss, Haver Sine, Lorentz, Dual-Tone, etc.
Frequency	Sine: 1uHz ~ 20MHz Square: 1uHz ~ 5MHz Ramp: 1uHz ~ 1MHz Harmonic: 1uHz ~ 15MHz Arb: 1uHz ~ 5MHz
Frequency Accuracy	±1ppm, 18~28°C
Sampling rate	150MSa/s
Waveform Length	8K
Vertical Resolution	12bit
Amplitude	2mVpp ~ 7Vpp (HighZ)

Impedance	50Ω
General Specifications	
Interface	USB Host, USB Device
Display	4.3-inch color TFT LCD screen
Power Voltage	100-120VAC _{RMS} (±10%),45Hz to 440Hz, CAT II 120-240VAC _{RMS} (±10%),45Hz to 66Hz, CAT II
Power Consumption	<30W
Fuse	T, 0.5A, 250V, 5x20mm
Environment	
Temperature Range	Operating: 0°C ~ 45°C Non-operating: -20°C ~ 60°C
Humidity Range	≤+104°F (≤+40°C): ≤90% relative humidity 106°F ~122°F (+41°C ~50°C): ≤60% relative humidity
Altitude	Operating: 3,000 meters No-operating: 15000 meters
Mechanical	
Dimension	310 x 265 x 110mm (L x W x H)
Weight	2.5 KG

Appendix B Accessories

This product comes with the following accessories, all of which can be obtained by contacting your local supplier.

Standard accessories:

- 1 BNC to BNC cable
- 2 alligator clip cables
- 1 power cord
- 1 USB cable
- Warranty Card
- Manufacturer Certificate
- Certificate Of Calibration