

Portable Power Station

User Manual

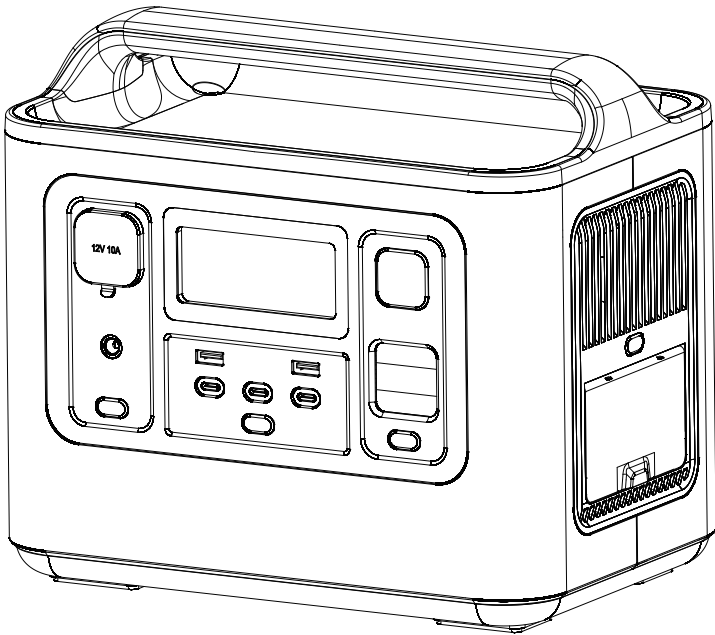

Thank you very much for purchasing 800W power station. Be sure to read this manual carefully before using the product in order to use the product correctly. This manual is needed for product after-sales service. Please keep this manual together with the invoice and other purchase certificates.

In order to ensure the safety of this product during transportation, this product is only charged about 30% when it is packaged. Please recharge when you get the product.

The product can be charged directly by the wall socket, please do not use extension cords and cable taps.

When the product is charging, do not plug other products in the same socket.





Warning

1. Please avoid using the product near high temperature, high humidity, direct sun environment and fire place.
2. Do not disassemble or modify this product, it will cause malfunction and fire.
3. Please discard or recycle the product according to the methods prescribed by local laws.
4. Be careful not to drop the product from a high place and give the product a strong impact.
5. Keep or use the product in a place out of the reach of children.
6. Please use our company's genuine accessories. The damage caused by the use of non-genuine accessories cannot be repaired free of charge.
7. Please leave a space of about 30cm away from the side suction and exhaust ports, so as not to affect the heat dissipation of the product.
8. When not using this product, please turn off the power and unplug the power cord. Please avoid storing the product in a place exposed to direct sunlight with high temperature and humidity.
9. For long-term storage, please consume power from full power to no power once every 3 months, and then recharge to about 50%.
10. Please do not use this product and its accessory cables and connecting equipment when there is a defect.
11. Please do not store the product for a long time in extremely high and low temperature places such as in the car and in the field warehouse to avoid shortening the battery life.

Content

AC Output Parameter	1
Packing List	2
Product introduction	2
Display icon introduce	6
UPS mode	7
Solar panel connection	8
Car charging	9
Specifications	10
Battery specification	10
Fault resolution	11
Warranty Card	12

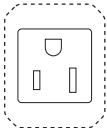
AC Output Parameter

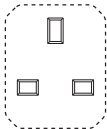
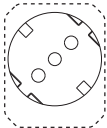
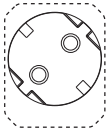
Type of AC port	AC output
 US/JP	100V~120V 50Hz/60Hz
 CH	220V 50Hz
 UK	220V~240V 50Hz/60Hz
 EU	220V~240V 50Hz/60Hz
 KR	220V 60Hz

Packing List



Power Station



AC Charger



User Manual



MC4 to XT60 Plug
Charging Cable

Product introduction

This product is a 512Wh large capacity 800W high power, 1.5 hours of high-speed charging portable energy storage power supply, using high safety performance of LiFePo4 battery.

It can be used as a backup power supply in case of emergency power cut, disaster, camping and vehicles, and can also provide power for various electric tools.

800W high power, pure sine wave AC output, can be used for household appliances such as dryers, microwave ovens, refrigerators, high-power induction cookers and it can also be used for other electronic devices such as personal computers.

Through the 400W ultra-fast charging, this model can be fully charged within 1.5 hours, The AC input/output voltage frequency can be automatically or manually switched between 50Hz/60Hz. This product also supports maximum 200W solar charge, allow you to charge even when the power cut or in outdoor situations



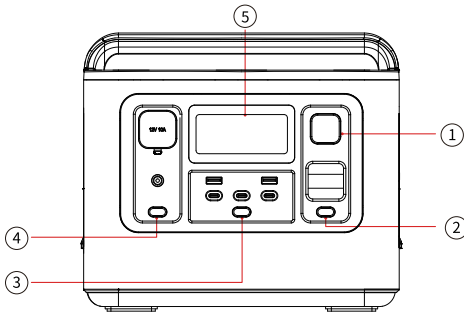

- ① Main power control
- ② Light control
- ③ USB control
- ④ DC control
- ⑤ LCD display

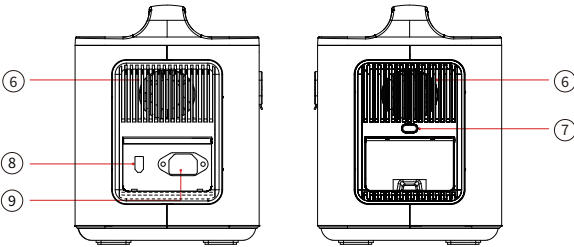

- ⑥ Air intake/outlet
- ⑦ AC on/off control(50Hz/60Hz switching control)
- ⑧ XT60 input port(for solar panel)
- ⑨ AC input port

① Main Power Control

Main Control for the whole system turn on/off.

Operate method: long press the button for 3s to turn on/off the system.



② LED light control

Operate method: short press to turn on and change the light mode (SOS/Flash).

Notice: you can turn off the light by long press the button(1-2s) in any mode.



③ USB button

Operate method: short press to turn on/off.

		
USB-A × 2	TYPE-C × 1	TYPE-C × 2
QC 3.0	PD-100W	PD-20W

④ DC button

Operate method:short press to turn on/off.

 6530 Output×1 12V/10A	 Cigar Lighter×1 12V/10A
---	---

⑤ LCD display

Present the remaining power and using data.

⑥ Cooling system

When the fans are working, please don't block the channel.

⑦ AC button(AC output, total share 800W)

Operate method:short press to turn on/off.

Notice: 1.Please confirm the output voltage or frequency before using

2.Long press the button for 3s to entry the frequency changing mode, 50Hz and 60Hz will blink in the display, press again the button to chose the right frequency, wait till the frequency is not blinking, then you will get the frequency you want.

3.Quick short press for 10 times to switch the voltage.

⑧ Solar panel input

Use the included XT60→MC4 conversion cable to connect the solar panel.

- 1.Solar panels can have a maximum input of 200W and a maximum voltage of 50V.
- 2.If exceeding the maximum voltage leads to equipment damage, it is beyond the scope of warranty.

⑨ AC Input

Use wall socket to get 400W fast charging, which can full charge from 0 to 100% in 1.5 hours.

- ※The product can be charged directly by the wall socket, please do not use extension cords and cable taps. When the product is charging, do not plug other products in the same socket.
- ※Please do not plug several devices together in a extension socket at once, the current will be to high and bring damage to the cable and fire risk.
- ※If the extension socket is plugged in to charge this product, please do not connect other electrical appliances to this socket, otherwise the household meter may trip.

Display icon introduce

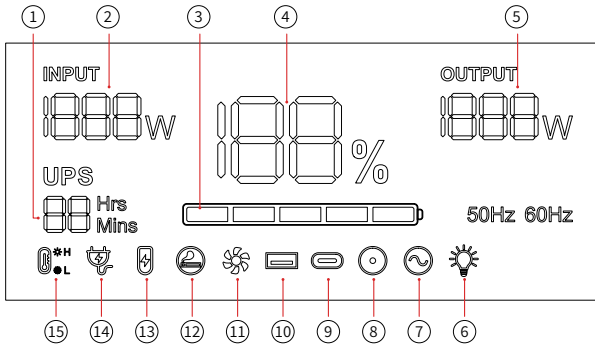

- | | | | |
|------------------------|----------------------|------------------------|-----------------------------------|
| ① Charging/using time | ⑤ Total output power | ⑨ Type-c output | ⑬ XT60 charging |
| ② Total input power | ⑥ LED light | ⑩ USB output | ⑭ AC charging |
| ③ Battery Progress Bar | ⑦ AC output | ⑪ Fan state | ⑮ High/low temperature protection |
| ④ Power percentage | ⑧ DC output | ⑫ Cigar lighter output | |

Display Attention



When this icon light up. Please keep Air intake/outlet unobstructed.



When this icon light up. Please note the device is now with high/low temperature and will possibly stop working till the temperature back to normal standard.



When this icon is blinking, represent that the AC input is fault, please recheck(Power/Hz/cable).



When the icon is blinking, represent the output is fault, please recheck.

UPS mode

• UPS function

This product has the bypass mode, does not need to pass through the battery, can directly output from the AC.

In UPS mode, when the AC input power of the mains is cut off due to a power outage, the ac input power of the mains can be used in about automatic switch to product battery power within 10 ms to ensure AC output.

• UPS Connections

As shown in the figure below, connect the product between the socket on the wall and the electrical appliances, and the power of the product is in the ON state. When you turn on the power of the electrical appliances, it will directly use the AC power of the power grid.

In this state, when the power grid is cut off, it will automatically switch to the product's internal battery to supply power.

※In UPS mode of The United States and Japan, the maximum power output of AC is below 800W, and the AC output exceeds 800W. The AC output icon "⊙" blinks indicating overload.

※In UPS mode of the China, United Kingdom, Europe and South Korea, AC output of the maximum power below 800W, AC output over 800W, "⊙" AC output icon flashes indicating overload.

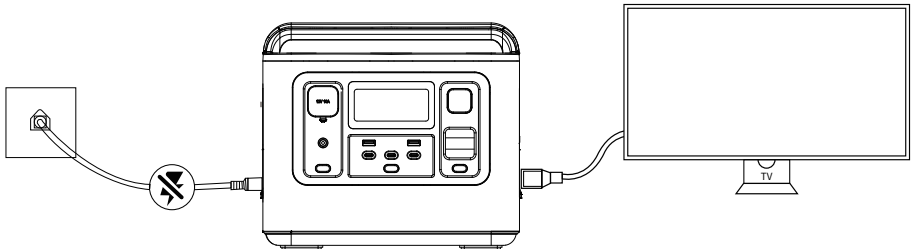

Solar panel connection

Our products can be connected to solar panels and can be charged through solar panels.

※Solar panel charging power, according to the weather and climate conditions.

※Solar panel voltage exceeding 50V will damage the equipment and may not be covered by warranty.

● By solar panels

Connecting Pattern①

The area of charging

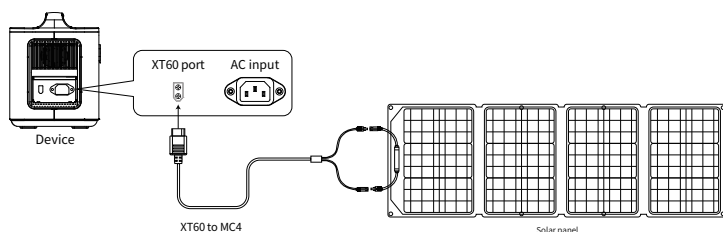

Connecting Pattern②

The area of charging

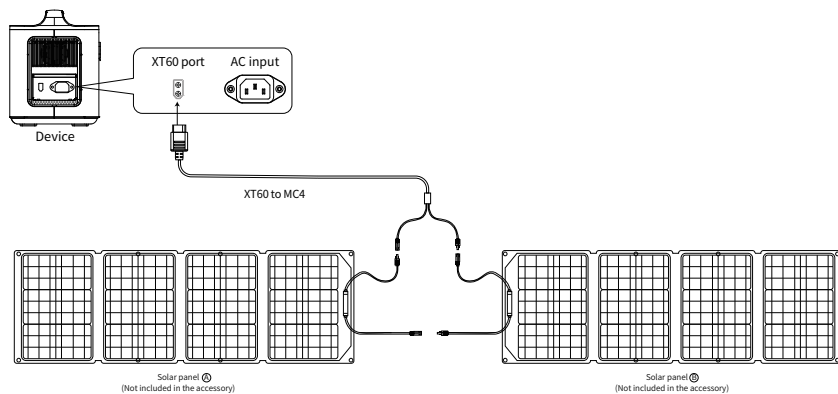

Car charging

This product can be charged by the cigarette lighter in the car with an ACC cable (accessory: ACC hereinafter).

Turn on the power of this product, connect the ACC charging cable to the cigarette lighter in the car and the XT60 interface on the side of the product, turn on the engine of the car, and the LCD of this product will show the input power.

- ※On-board charging should be carried out with the car engine turned on. If the engine is not turned on, the battery might run out.
- ※Car charging is usually low power of 90-120W, and the charging time will be long. If you need quick charge, it is recommended to use the mains.

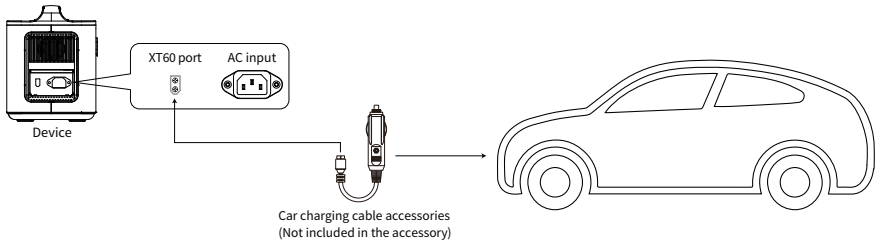



Specifications

Product name	800W Portable Power station
Product size	L*W*H=272*184.5*240mm
Product weight	6.5kg
Capacity	512Wh
AC Charging	50/60Hz 400W max
MPPT input	11.5-50V 8A 200W max
AC output	800W 50Hz/60Hz,pure sine wave
USB-A output	(QC 3.0 18W)x2
Type-C output	(PD 100W)x1 ; (PD 20W)x2
DC 6530 output	12V/10A
Cigar lighter output	12V/10A
Power off current	<500uA
Operating temperature	-10~40°C
Charging temperature	0~40°C
Environment humidity	≤90%RH

Battery specification

Battery type	40135 LiFePo4
Single cell rated voltage	3.2V
Single cell rated capacity	20Ah
Battery pack rated voltage	25.6V
Battery pack output voltage	21V-29V
Battery pack rated capacity	512Wh

Phenomenon	Cause	Processing method
 <p>The above output icon flashes and beeps.</p>	<p>The output exceeds the standard and it's short-circuited.</p>	<p>Remove the load, and then short press the switch in the area corresponding to the icon to remove the alarm</p>
 <p>The temperature warning icon flashes and beeps.</p>	<p>The temperature of the product is too high or too low.</p>	<p>Take the product out of the charging state, remove all loads, turn the power off, wait for the device to reach a suitable working temperature, then the alarm is removed.</p>
 <p>The icon of connecting to the AC mains flashes and the product cannot be charged.</p>	<p>The charging cable is poorly connected.</p>	<p>The overload protection function is enabled.</p>

If you have any questions, please feel free to contact us.

Email address: support@aferyjapan.com.

Sincerely,

Warranty Card

Warranty Card	
Model	
Name	
Address	
Tel	
Mail	
Name of the store	
Buying date	
Please fill in all the above items.	

This product provides a 24-month warranty service from the date of purchase

- If there is a quality problem within the range of normal use, we provide warranty service.
- After purchasing our company's products, please keep this product together with invoices and other items. When maintenance services are needed, please provide information according to our company's request.
- In the case where the warranty is damaged or altered, and no stamp of the sales store on the warranty, the warranty service may not be provided.
- Damage caused by use beyond the normal range of use is not covered by the warranty service.
- The content of the warranty scope shall be subject to the content recognized by the company.
- Even within the scope of the warranty, sometimes it will be exchanged for products with the same function. The shipping and repair fees for products outside the warranty range shall be paid by the customer.
- Sometimes the specifications and functions of the product will be updated without prior notice.