

HU-064 High Voltage Electromagnetic Transmitter DIY Kit

1.Introduction:

HU-064 is a DC 3V High Voltage Electromagnetic Transmitter DIY Kit. It can simulate an electromagnetic transmitter and convert electrical energy into magnetic energy, thereby injecting a metal cylinder. Users can use it to learn and understand the working principle of electromagnetic transmitters and learn the basics of electronic technology.

It is a very interesting DIY electronic product which enables users to understand the circuit more clearly and learn soldering skills.

2.Feature:

1>.Instructions & Steps for Usage:1>Turn ON black power switch to charge the capacitor; 2>.Wait for approximately 10-30 seconds to complete charging and the blue/red LED is charge indicator and slowly brighten up; 3>.Insert the metal cylinder from the rear end of the plastic tube, and its tail should be flush with the tail of the tube; 3>.Press the launch button (red button), the metal cylinder will fly out, and the launch is complete.

2>.DIY Hand Soldering: It's a DIY kit which comes with various components. User need to install each component by hand. It not only can exercise and improve soldering skills, but also increase the interest in electronic technology. Great for electronics hobbyists, beginners, school and home education.

3>.Easy to Assemble: During the assembly process, the kit requires not all soldering, and more needs to connect the circuit and assemble the components. We have prepared a detailed user manual for you. The connection that was clearly mapped and labeled on the board, easy to build and the principle is simple. But still requires certain foundation of basic electronic theoretical knowledge and welding and hands-on ability.

4>.Please Pay Attention: 1>.Do not touch the metal parts with your hands when it is charged. The finished project is a device that works under high voltage. 2>.Please discharge the energy storage capacitor before troubleshooting. Please refer to user the manual for detailed discharge operation. 3>.Children under the age of 14 need to be installed and used it under the supervision of an adult.

5>.Warm Tips: 1>. It can be launched once each time, and after the launch is completed, it needs to be recharged. 2> Relax as soon as possible after pressing the launch/red button.

3.Parameter:

- 1>.Work Voltage: DC 3V
- 2>.Charging Current: 50~60mA
- 3>.Discharging Current: 70~80mA
- 4>.Power Type:AA*2 Battery(Not Included!)
- 5>.Work Temperature:-20℃~85℃
- 6>.Work Humidity:5%~85%RH
- 7>.Size(Installed):94*87*84mm

4.Use Steps:

- 1>.Complete the installation correctly according to the installation manual.
- 2>.Turn ON black KCD-11 power switch then the green power indicator will turn ON.
- 3>.Automatically start to charge the capacitor after power ON and the blue and red LED is charge indicator and slowly brighten up.
- 4>.It means that the capacitor charging has reached 50% when the blue indicator turn ON completely. Charging time is approximately 10-30 seconds.
- 5>.It means that the capacitor charging has reached 100% when the red indicator turn ON.
- 6>.Insert the cylindrical metal rod from the rear end of the plastic tube, and its tail should be flush with the tail of the tube.
- 7>.Press red DS-316 momentary launch switch between 50% to 100% to cylindrical metal rod that will

fly out, and the launch is complete. 50% can be launched, no need to wait for 100%.

5. Notes:

- 1>.The instantaneous voltage inside the circuit board reaches about 210V, so please don't touch component during charging.
- 2>.Do not wear or damage the insulation layer on the surface of the wire.
- 3>.The capacitor must be discharged first before circuit testing. The capacitor has been discharged if the blue indicator turn OFF.
- 4>.Its power consumption is relatively fast, the working voltage is about 50mA when charging, so it is recommended to use a new battery.
- 5>.Its working voltage is 3V, so the input voltage must not exceed the working voltage.
- 6>.It can be launched once each time, and after the launch is completed, it needs to be recharged.
- 7>.The launch distance is related to the horizontal position, Iron Pillar's position and many other factors.
- 8>.Before stopping use, it is recommended to fire several times to release the electric energy inside the capacitor.

6. Component Listing:

NO.	Component Name	PCB Marker	Parameter	QTY
1	Metal Film Resistor	R5	1Kohm	1
2	Metal Film Resistor	R1,R6	5.1Kohm	2
3	Metal Film Resistor	R2,R3	10Kohm	2
4	Metal Film Resistor	R4	470Kohm	1
5	1N4148 Diode	D1	DO-35	1
6	2EZ91D5 Zener Diode	D2	DO-41	1
7	S9013 Transistor	Q1,Q2	TO-92	2
8	5mm Green LED	LED1	Green	1
9	5mm Blue LED	LED2	Blue	1
10	5mm Red LED	LED3	Red	1
11	KCD-11 Switch	K1	2Pin	1
12	Electrolytic Capacitor	C1	1000uF	1
13	DS-316 Momentary Switch	K2	Red	1
14	Magnetic Induction Coil	U1	6Pin	1
15	Electromagnetic Coil	L4	12Pin	1
16	Metal Cylinder		4*12mm	5
17	Red/Black Wire		120mm	3
18	AA*2 Battery Box	BAT1		1
19	Transparent Plastic Pipe		M10*70mm	1
20	Double-Sided Tape			1
21	Acrylic Board			6
22	White Isolation Column		M3*6mm	4
23	M3*10+6mm Copper Column			4
24	M3*12mm Screw			4
25	M3*5mm Screw			4
26	M2*10mm Screw			4
27	M3 Nut			4
28	M2 Nut			4
29	Metal Cap			4
30	PCB Circuit Board		85*78mm	1
31	PCB Circuit Board		53*50mm	1
NOTE:Users can complete the installation according to the PCB silk screen and component list.				

7.Schematic Diagram:

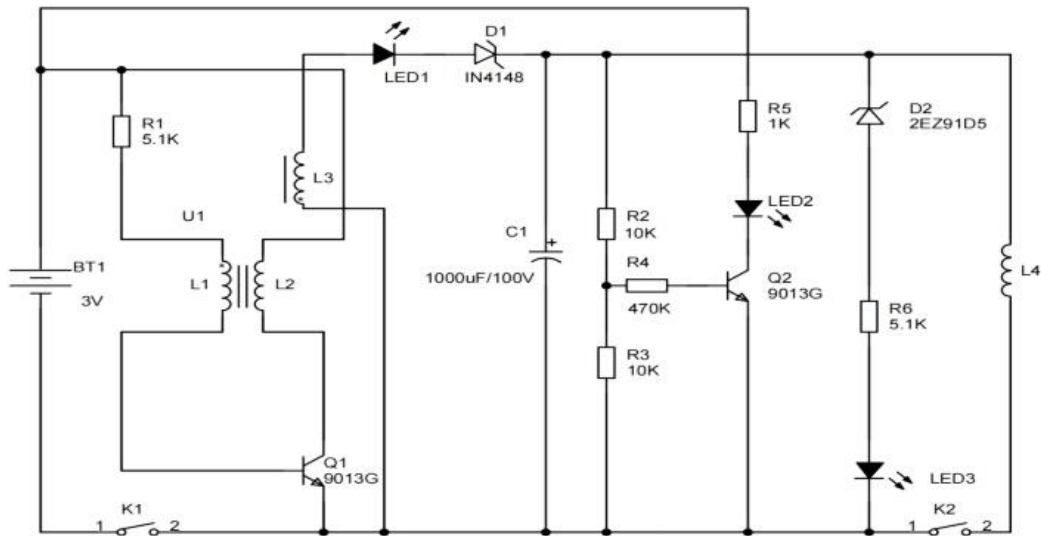

8.Application:

- 1>.Training welding skills
- 2>.Student school
- 3>.DIY production
- 4>.Project Design
- 5>.Electronic competition
- 6>.Gift giving
- 7>.Crafts collection
- 8>.Home decoration
- 9>.Souvenir collection
- 10>.Graduation design
- 11>.Holiday gift

9.Installation Tips:

- 1>.User needs to prepare the welding tool at first.
 - 1.1>.Soldering iron (<50 Watt)
 - 1.2>.Rosin core ("radio") solder
 - 1.3>.Wire cutters
 - 1.4>.Wire strippers
 - 1.5>.Philips screwdriver
- 2>.Please be patient until the installation is complete.
- 3>.The package is DIY kit.It need finish install by user.
- 4>.The soldering iron can't touch the components for a long time(3s), otherwise damage components.
- 5>.Pay attention to the positive and negative of the components.
- 6>.Strictly prohibit short circuit.
- 7>.User must install the LED according to the specified rules.Otherwise some LED will not light.
- 8>.Install complex components preferentially.
- 9>.Make sure all components are in right direction and right place.
- 10>.Check that all of the LED can be illuminated.
- 11>.It is strongly recommended to read the installation manual before starting installation!!!
- 12>.Please wear anti-static gloves or anti-static wristbands when installing electronic components.

10.Installation Steps(Please be patient install!!!):

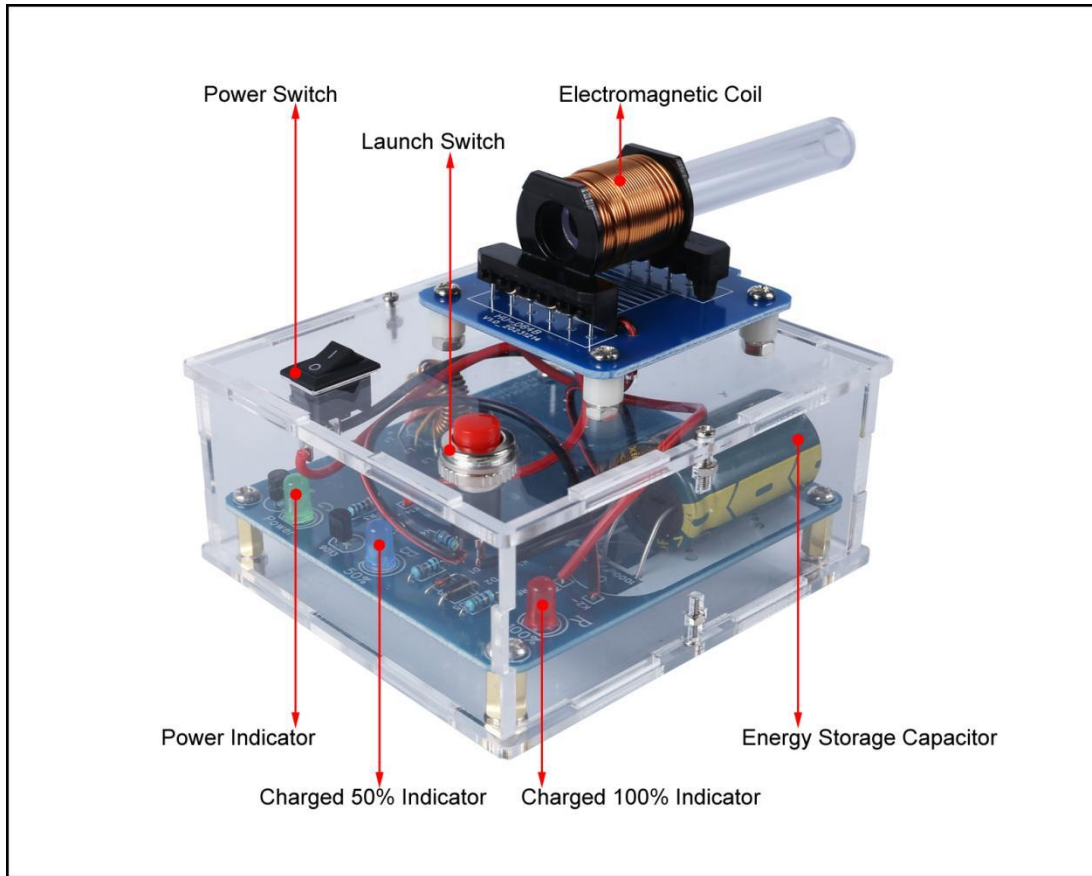

Step 1: Install 2pcs 10Kohm Metal Film Resistor at R2,R3.

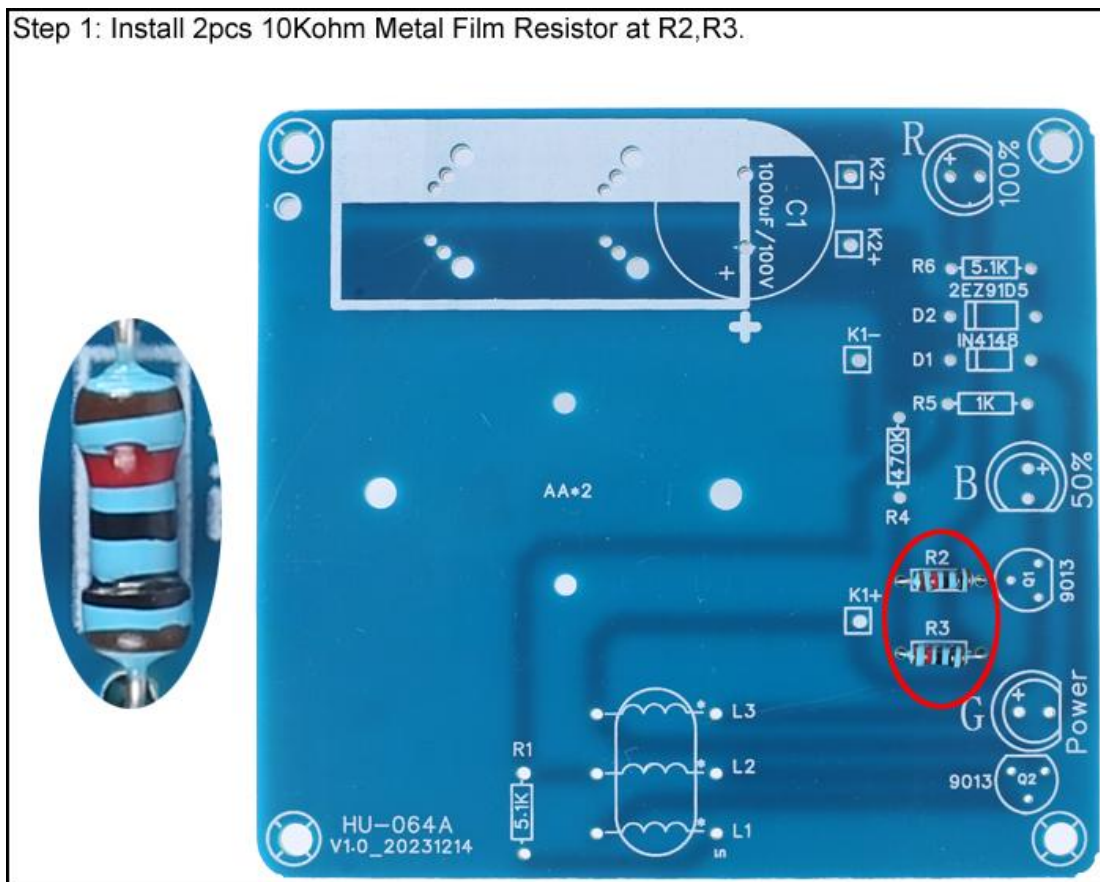

Step 2: Install 2pcs 5.1Kohm Metal Film Resistor at R1,R6.

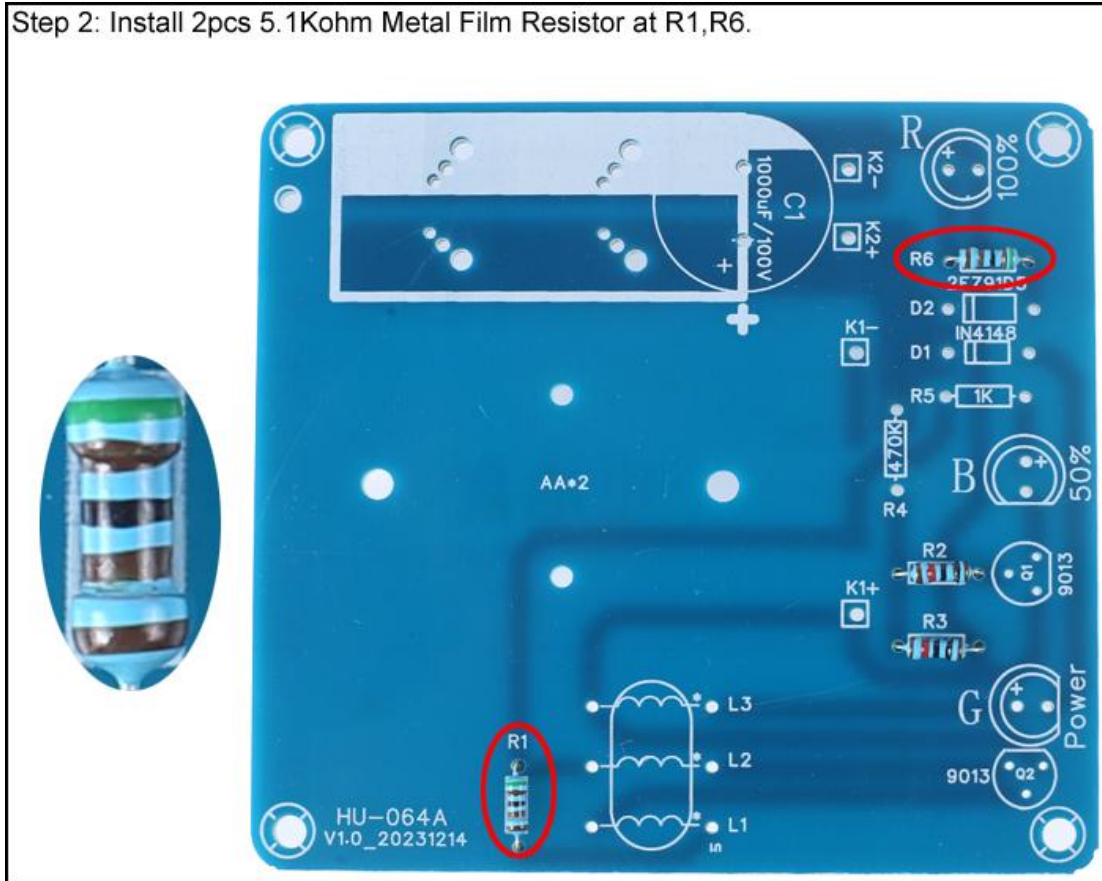

Step 3: Install 1pcs 470Kohm Metal Film Resistor at R4.

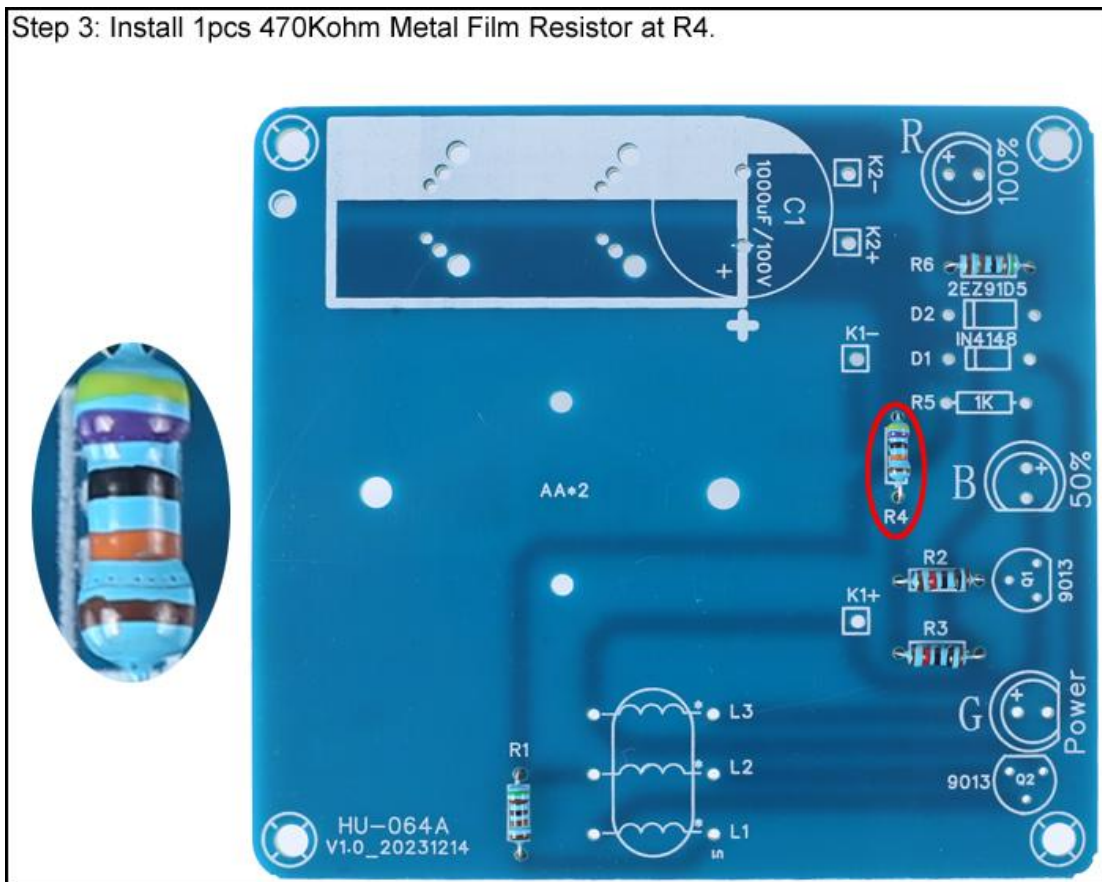

Step 4: Install 1pcs 1Kohm Metal Film Resistor at R5.

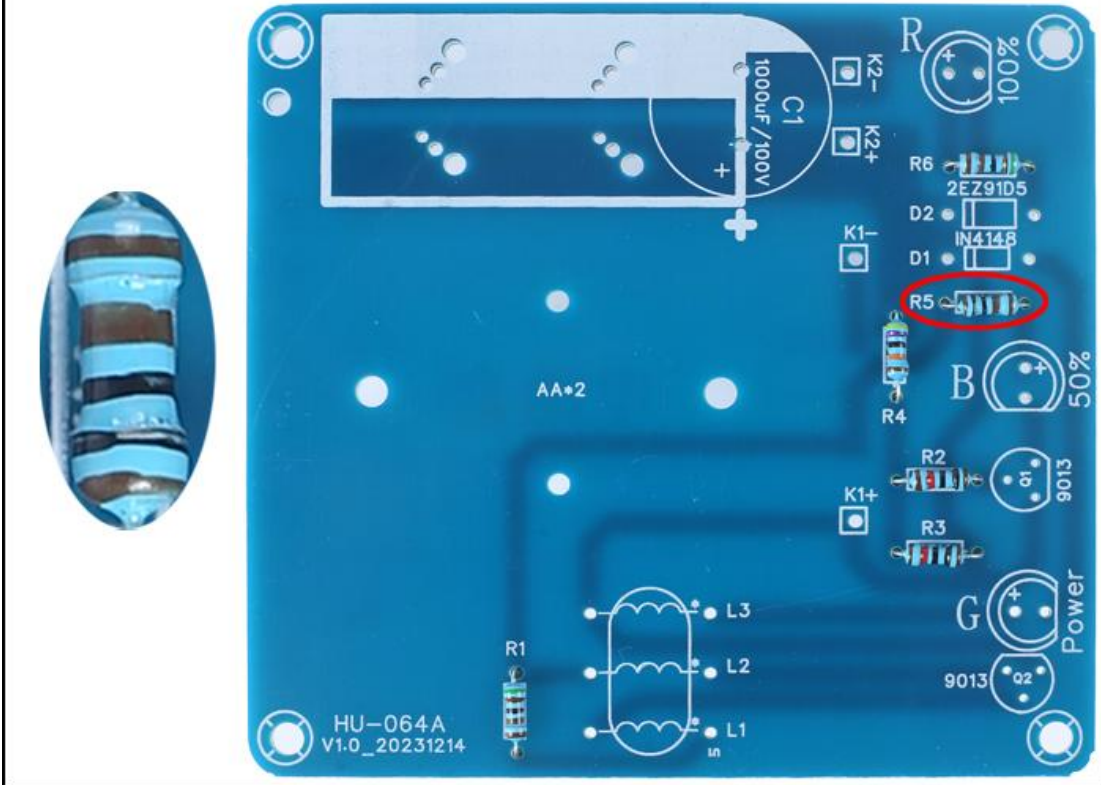

Step 5: Install 1pcs DO-35 1N4148 Diode at D1. Pay attention to the installation direction. There is a black mark on 1N4148 and a white mark on PCB which are used to confirm the installation direction.

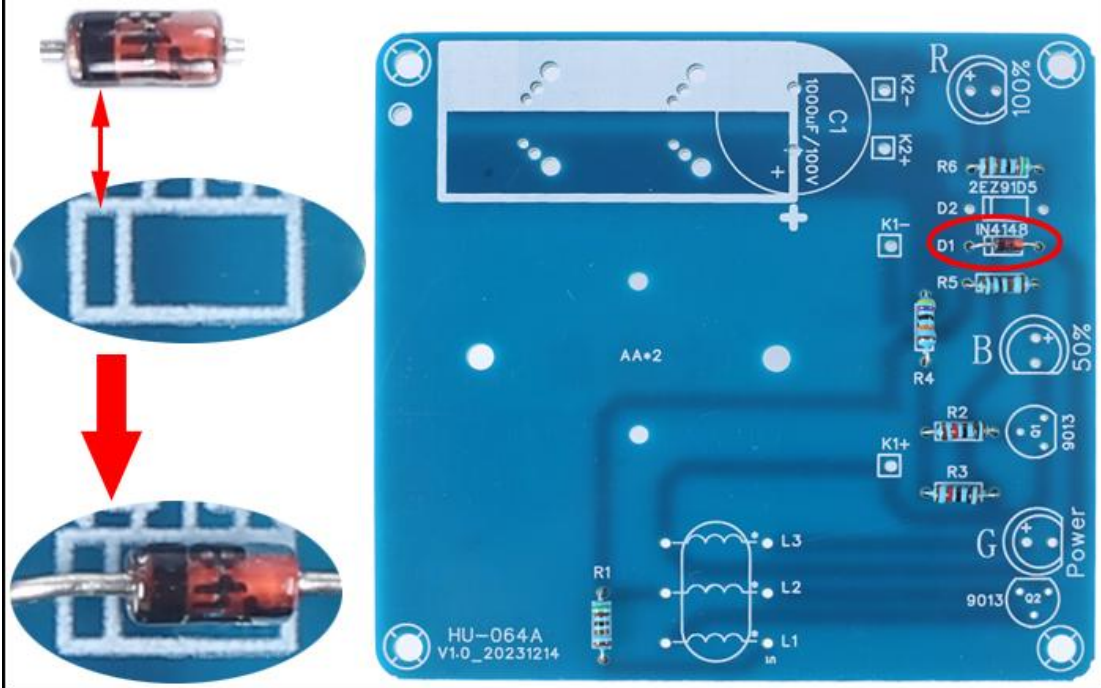

Step 6: Install 1pcs DO-41 2EZ91D5 Zener Diode at D2. Pay attention to the installation direction. There is a white mark on 2EZ91D5 and a white mark on PCB which are used to confirm the installation direction.

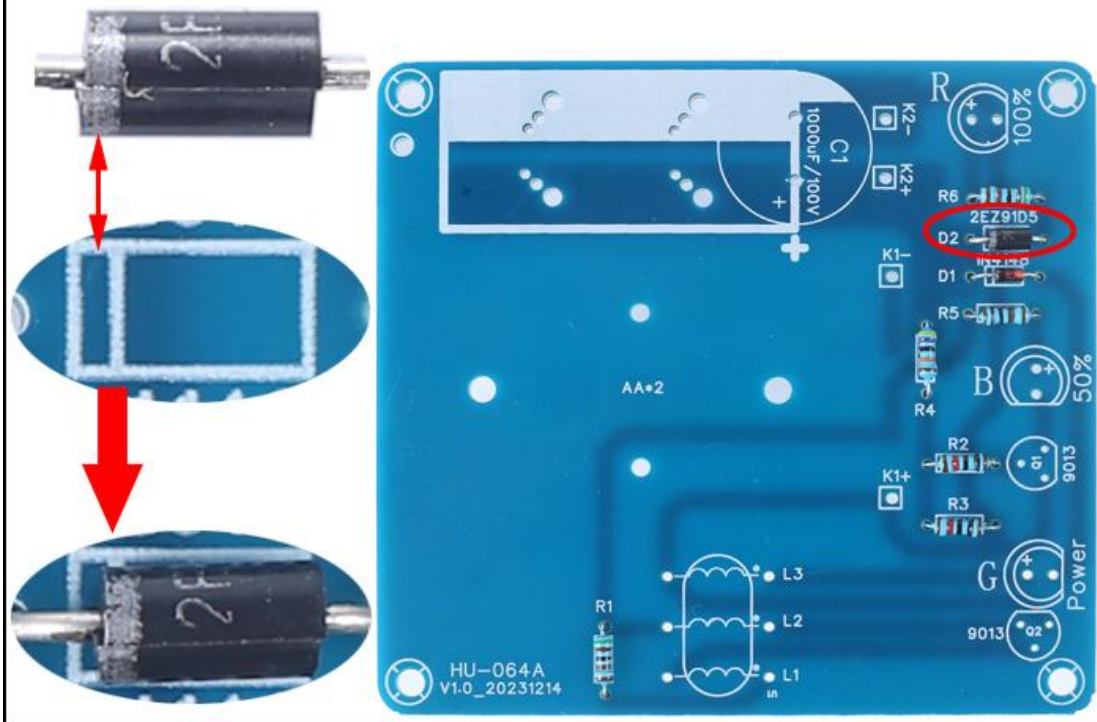

Step 7: Install 2pcs TO-92 S9013 Transistor at Q1,Q2. Pay attention to the installation direction. The arc on the PCB corresponds to the arc of the components.
 Note: Separate three pins.

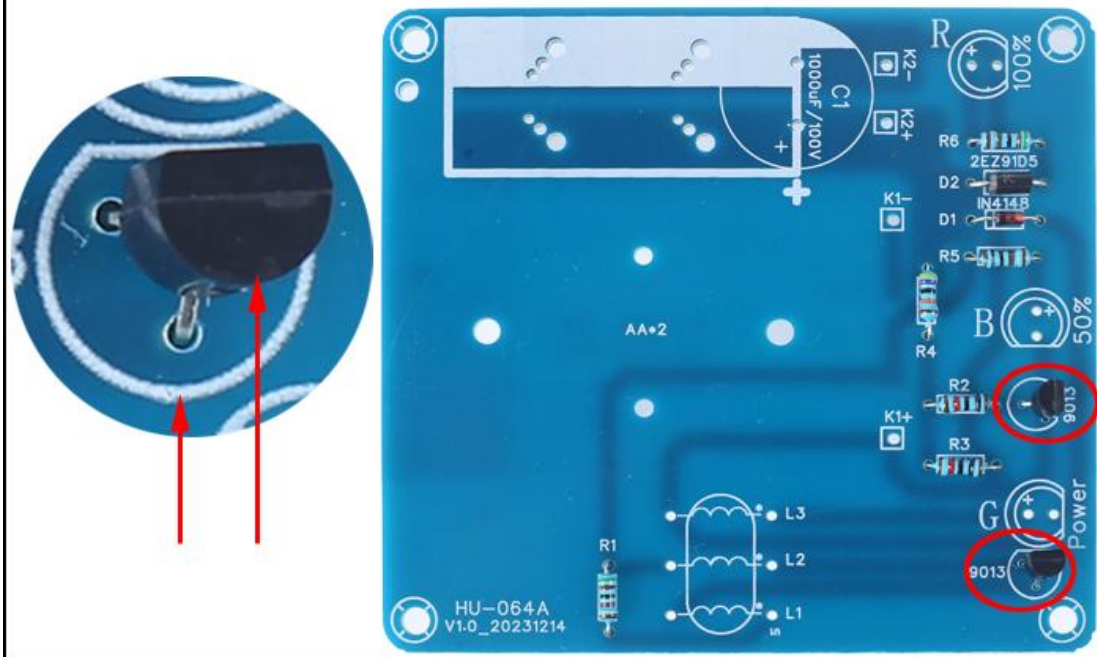

Step 8: Install 1pcs 5mm Green LED at LED1/G, Blue LED at LED2/B, Red LED at LED3/R. Note: The longer pins are positive pole and connect to ' + ' pads.

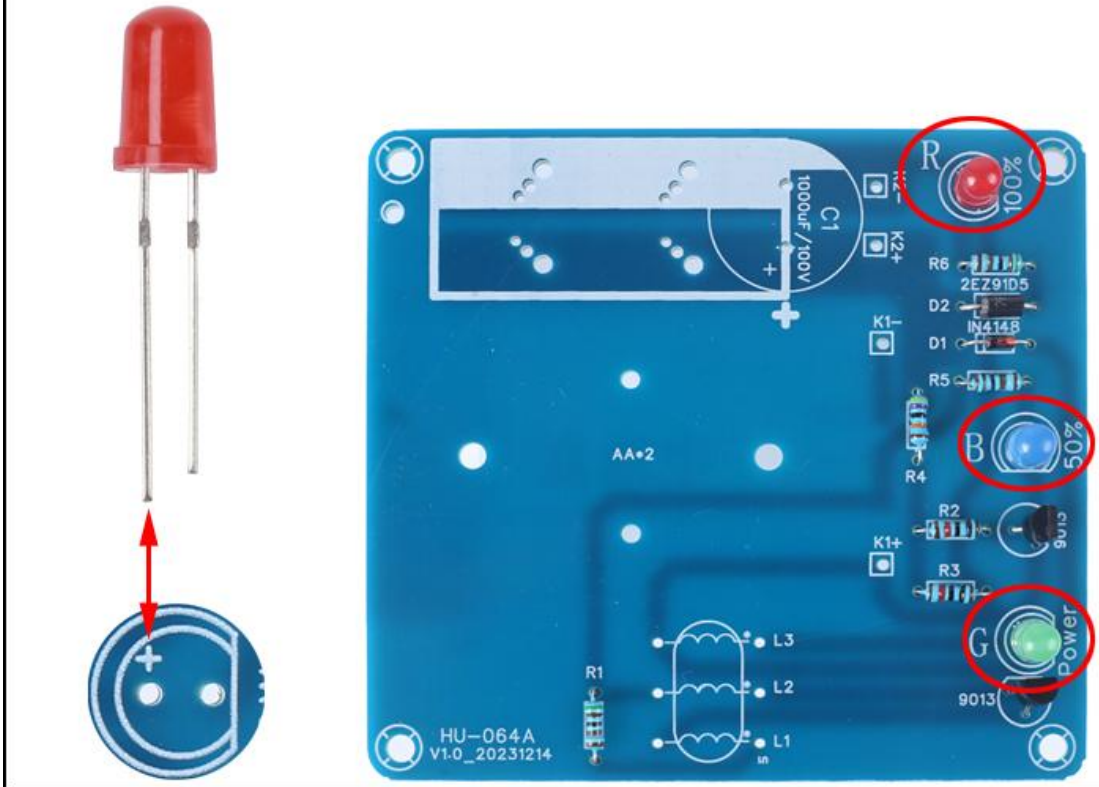

Step 9: Install 1pcs 6Pin Magnetic Induction Coil at U1. Note: Red wire connect to L1, Orange wire connect to L2, Coppery wire connect to L3.

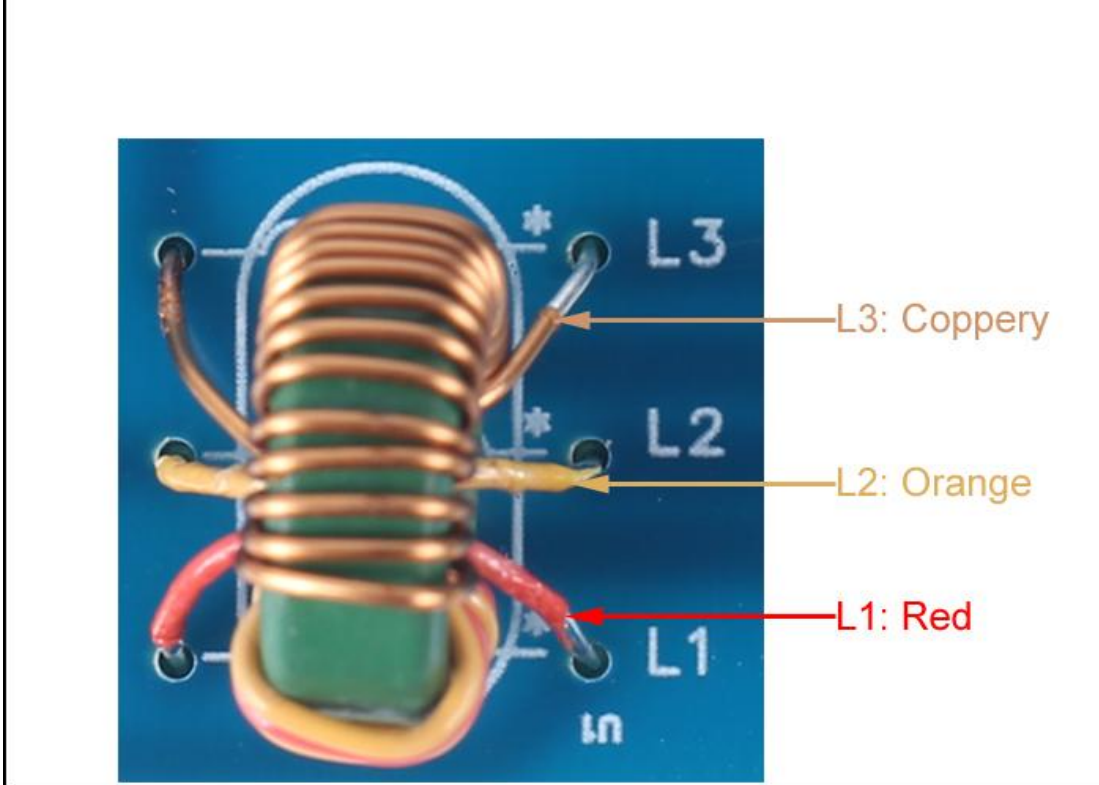

Step 10: Install 1pcs 1000uF Electrolytic Capacitor at C1 in horizontal placement. The longer pin is positive pole and connect to ' + ' pad.

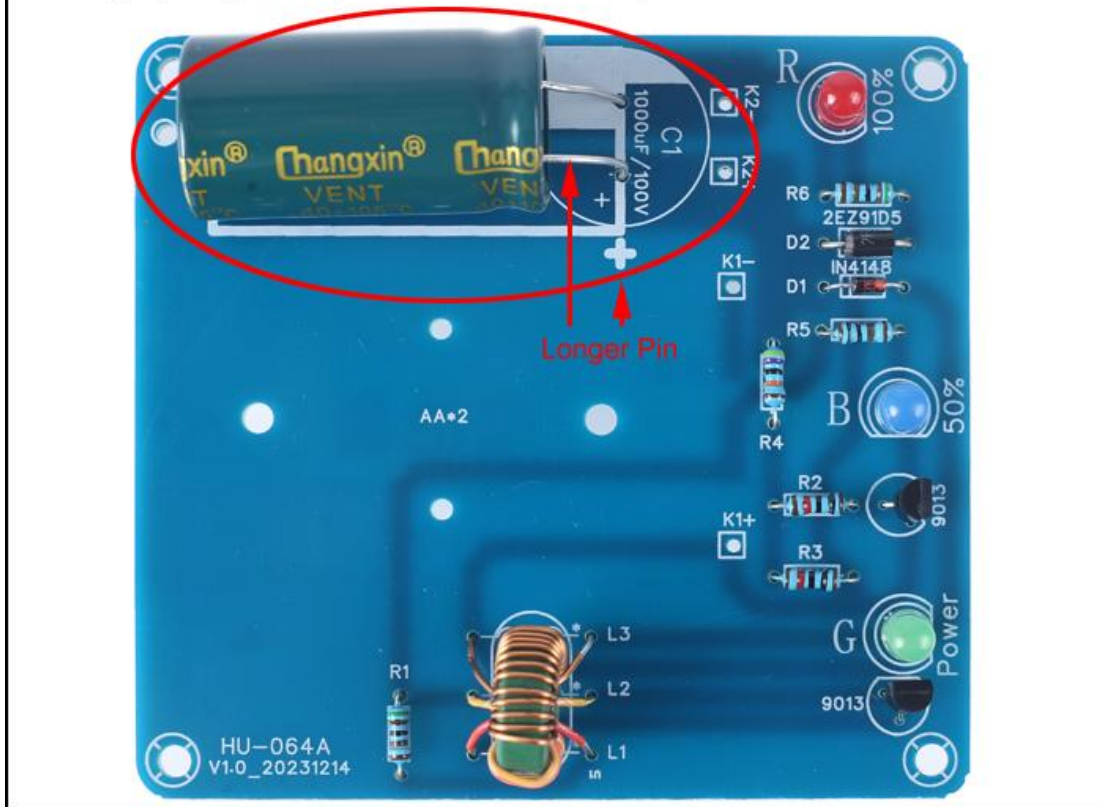

Step 11: Disassemble 3pcs Red/Black wires to 6pcs wires. Then connect 1pcs red wire to ' K1+ ' pad and 2pcs red/black wires to ' K1- ' and ' K2- ' pads.

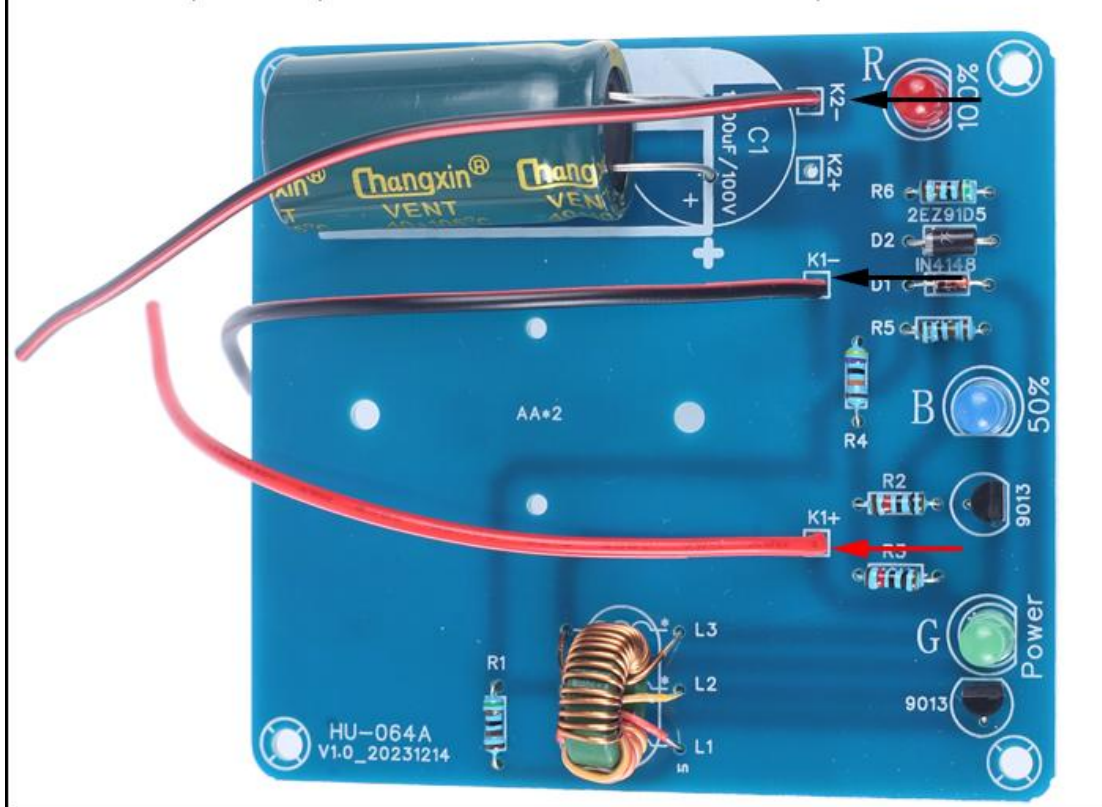

Step 12: Install 1pcs 16Pin Electromagnetic Coil on Smaller PCB. Note: Pay attention to the coil mark and PCB silk screen, they are used to determine installation direction.

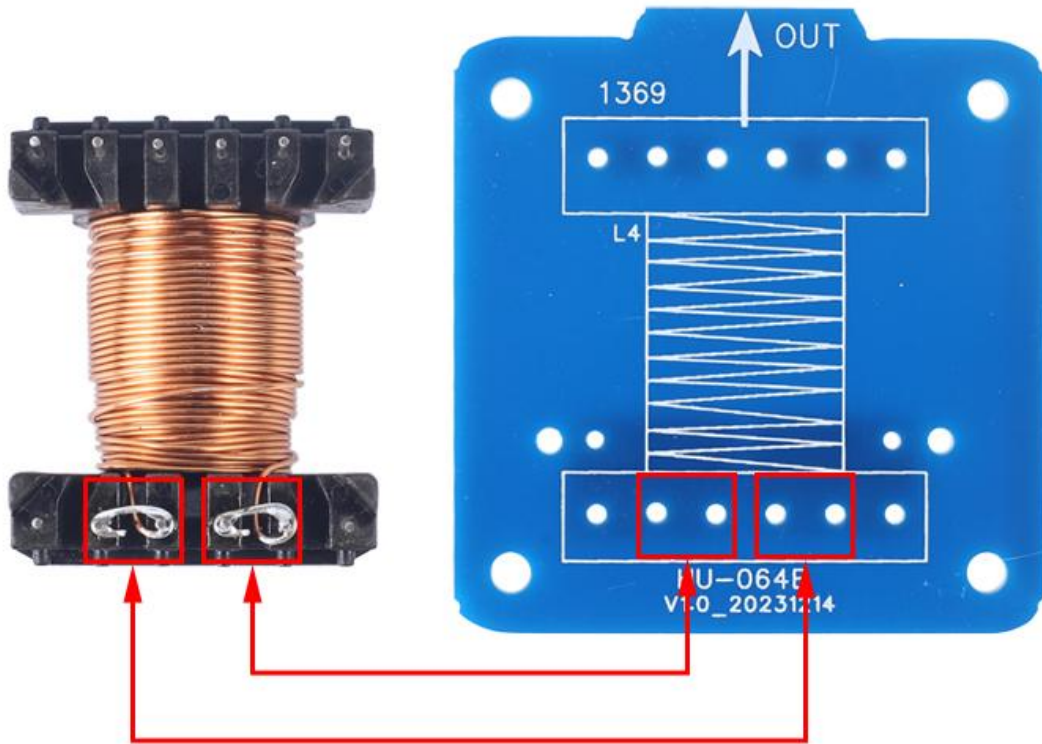

Step 13: Connect 2pcs wire on the Smaller PCB. Red wire on left and red/black wire on right. Note: Wires pass through 2 holes.

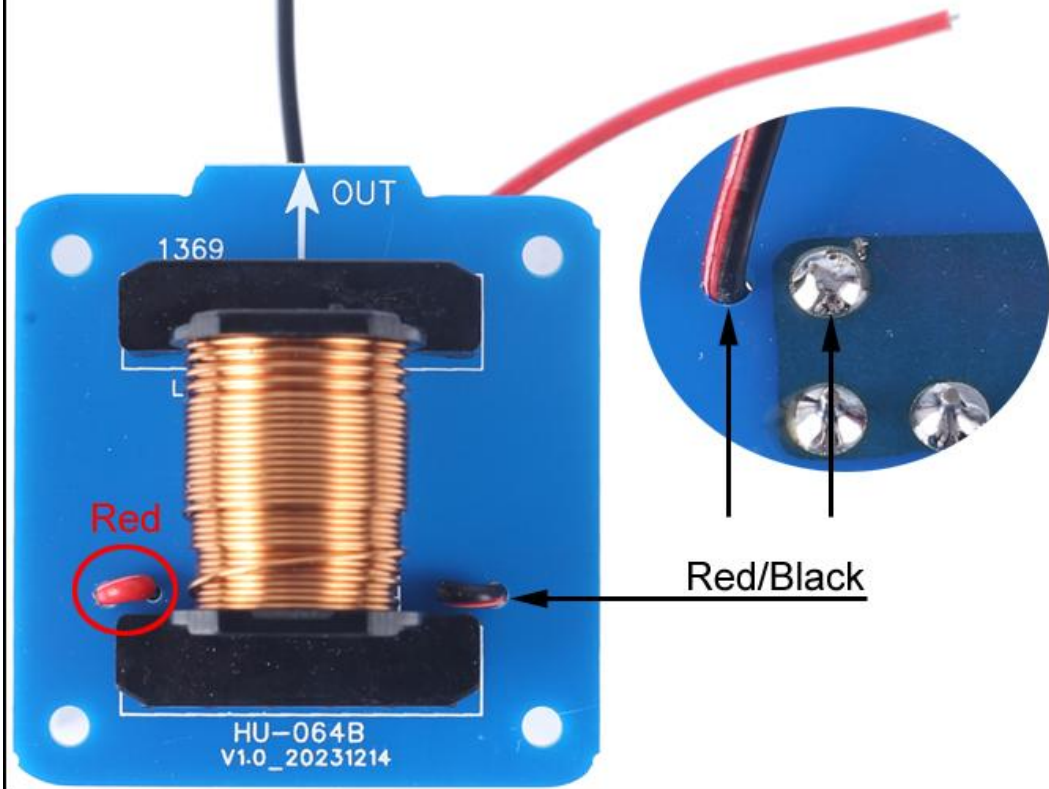

Step 14: Tear off the protective film on the black acrylic surface.



Step 15: Remove screw and gasket from Red DS-316 Momentary Switch.



Step 16: Fix Red DS-316 Momentary Switch on TOP Acrylic Board by removed screw and gasket.



Step 17: Pass two wire through holes on TOP Acrylic Board from the Smaller PCB.

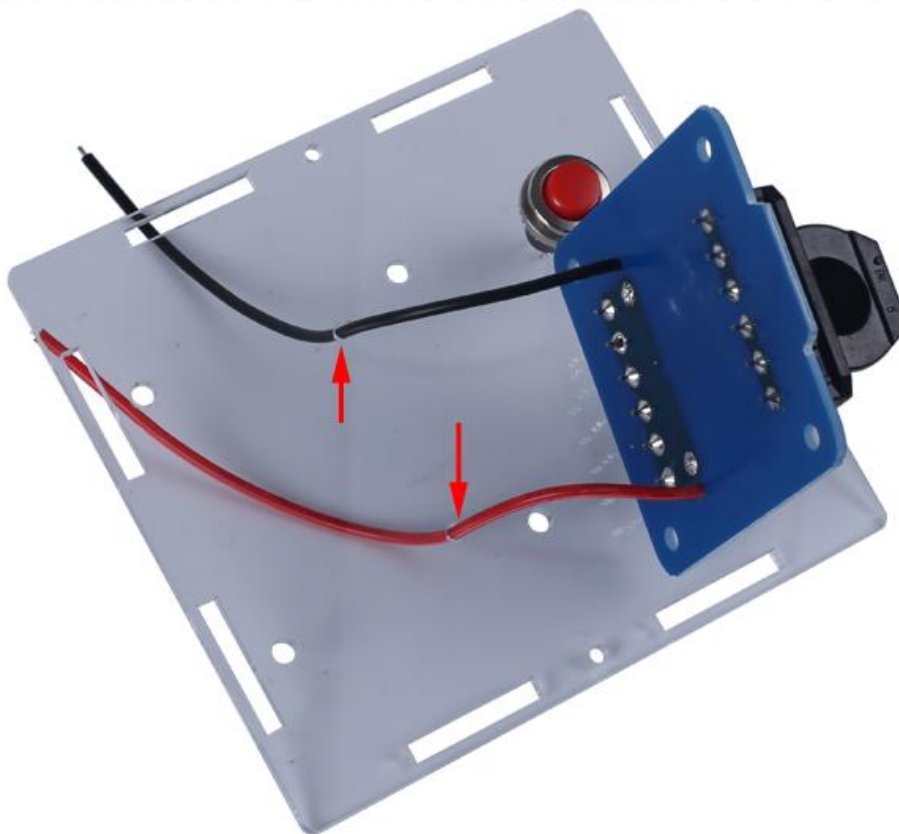

Step 18: Fix the Smaller PCB on TOP Acrylic Board by 4pcs M3*12mm Screw, 4pcs M3*6mm White Isolation Column, 4pcs M3 Nut.

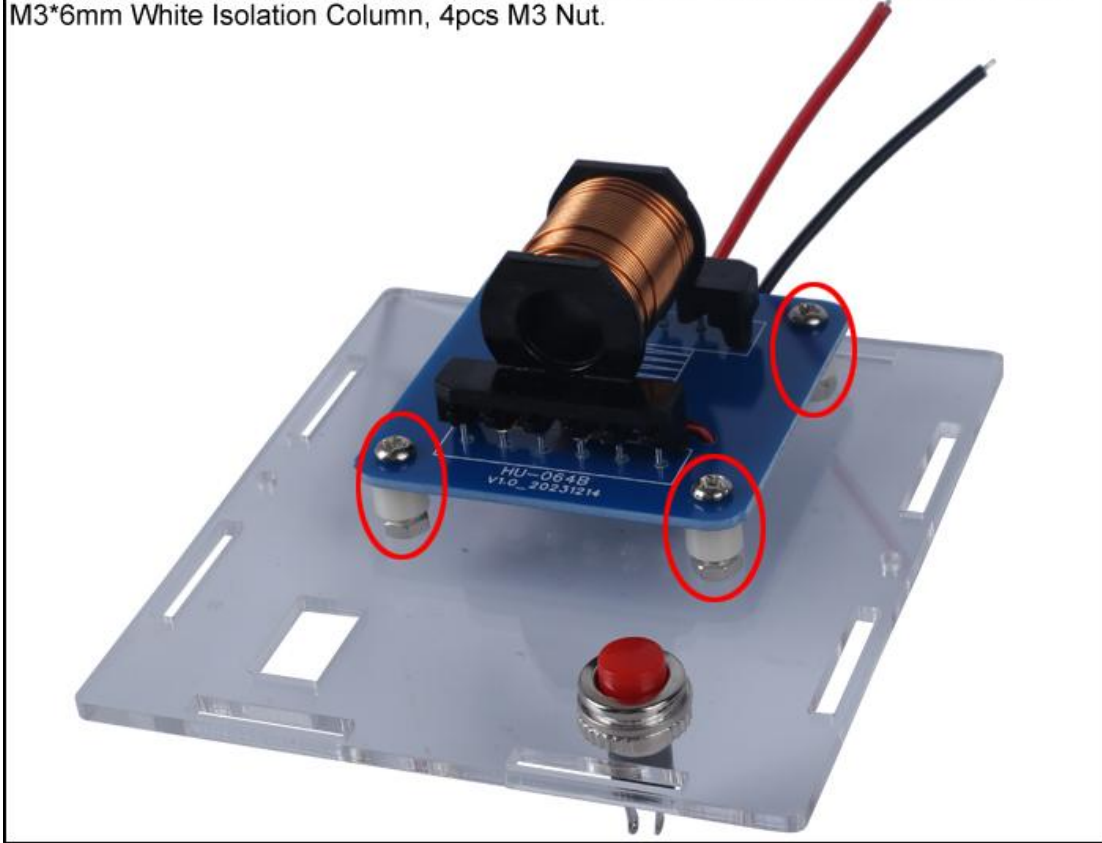

Step 19: Connect red/black wire from the Smaller PCB to any one pin of Red DS-316 Momentary Switch.

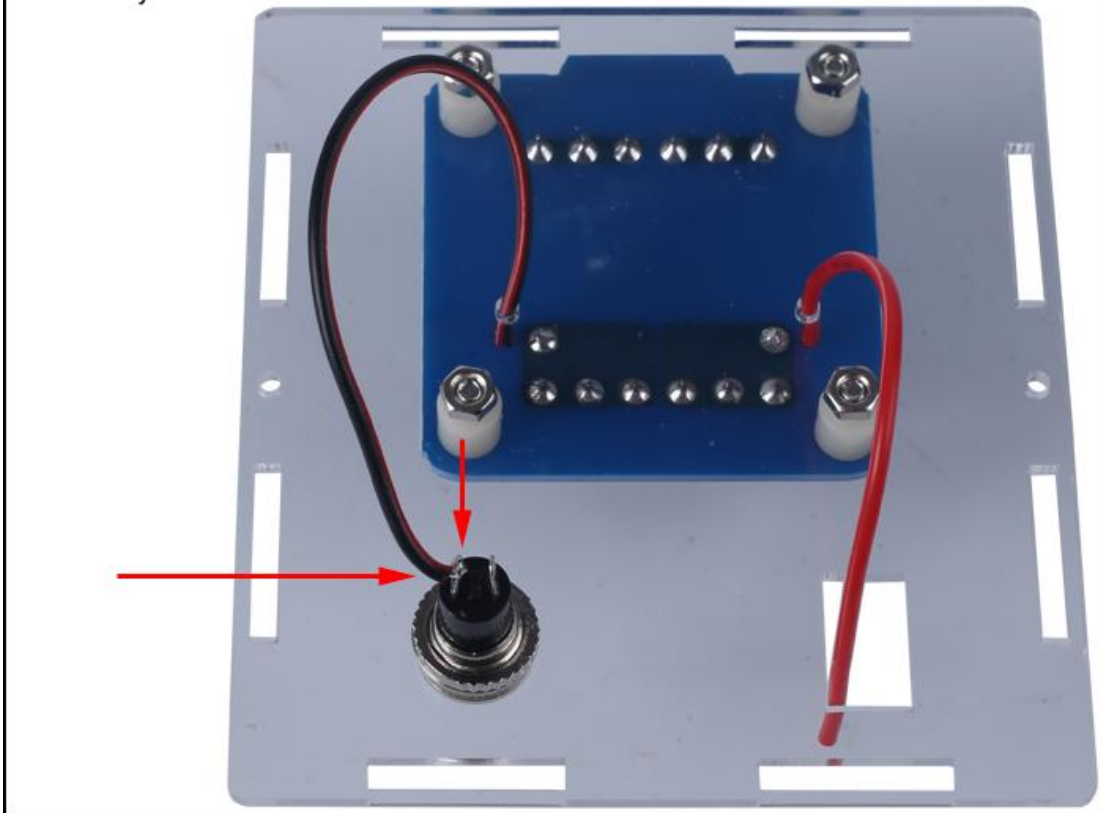

Step 20: Connect red/black wire from ' K2- ' pad on the Bigger PCB to the another pin of Red DS-316 Momentary Switch.

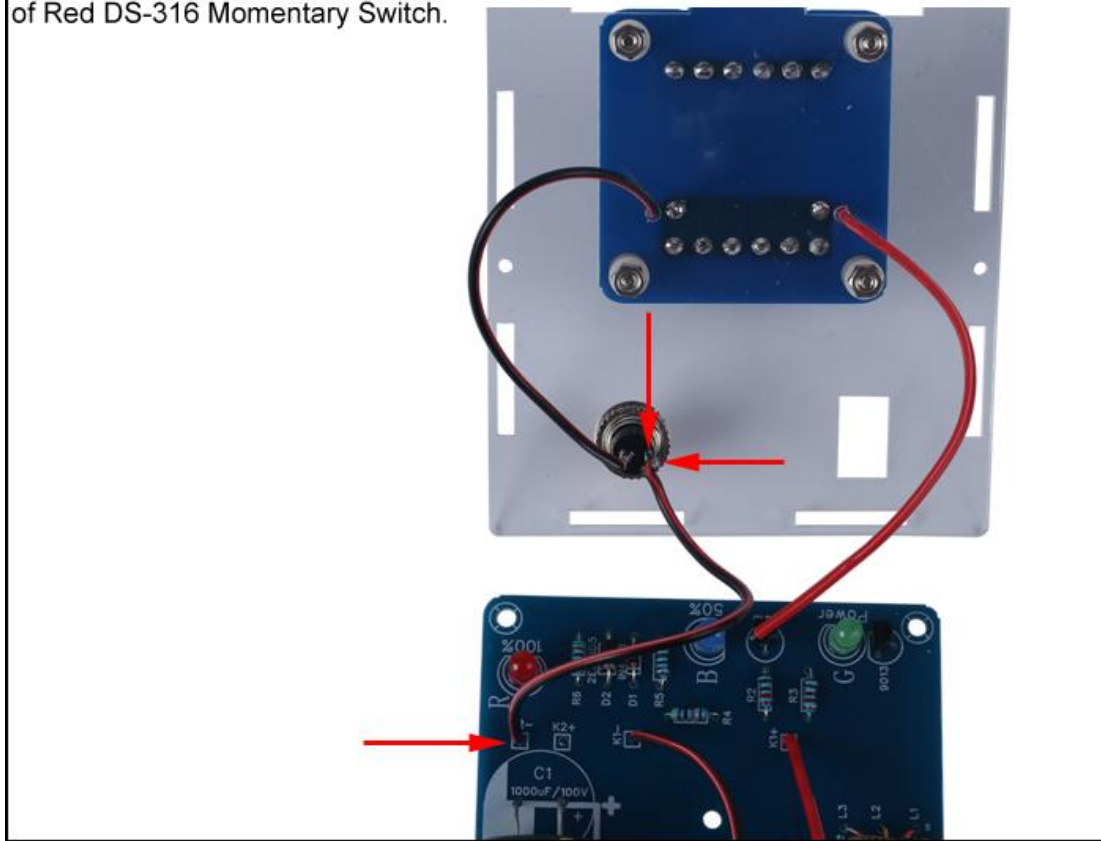

Step 21: Connect red wire from the Smaller PCB to ' K2+ ' pad on the Bigger PCB.

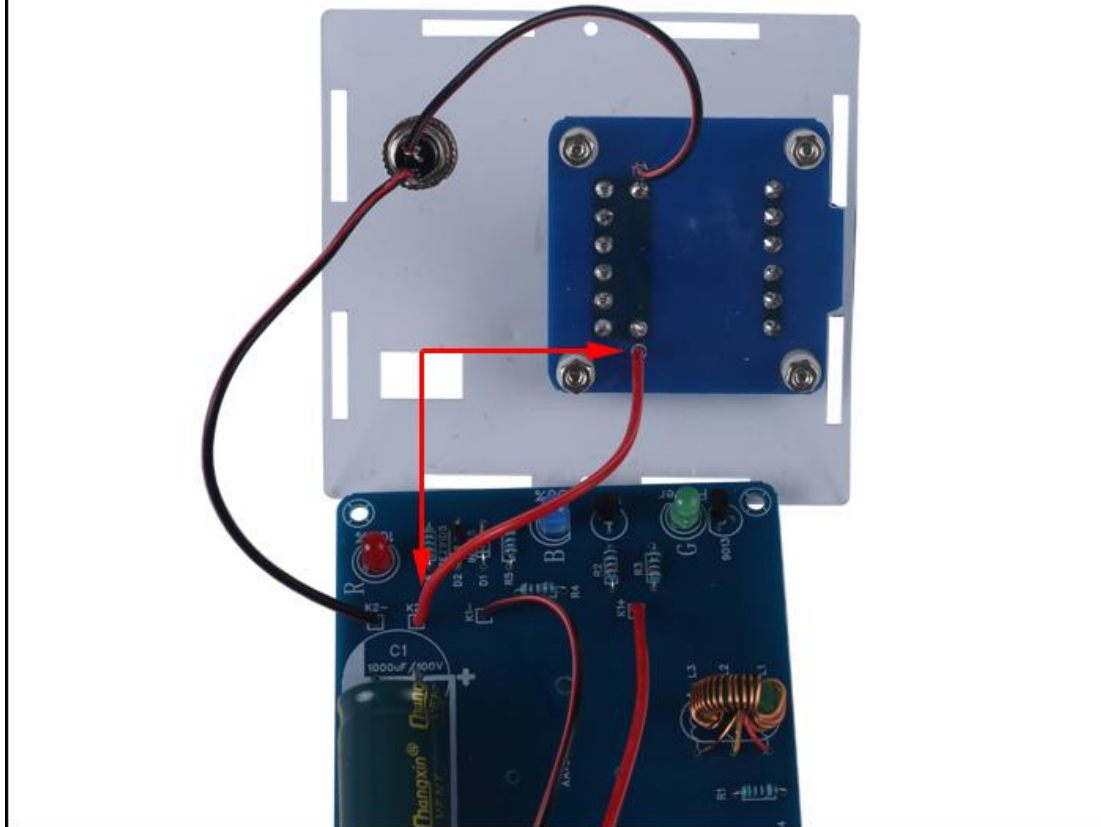

Step 22: Fix KCD-11 Power Switch on TOP Acrylic Board with its clip. Insert the acrylic mounting hole with force, but do not damage the acrylic.

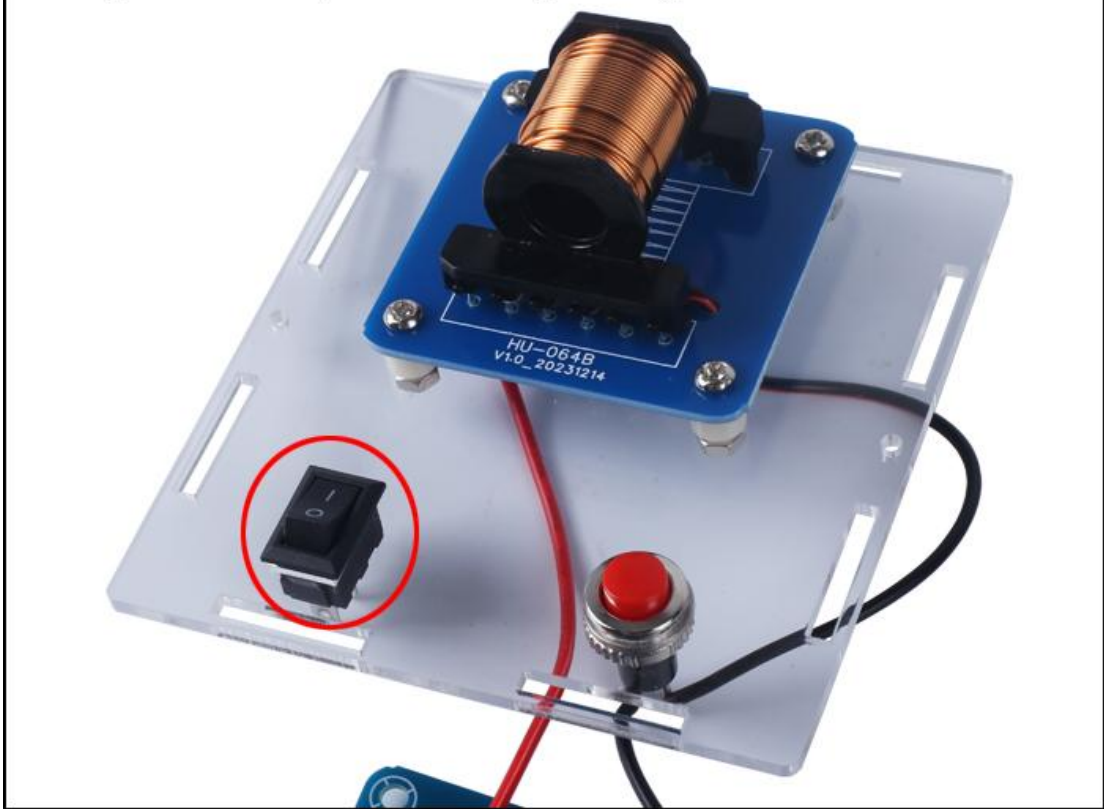

Step 23: Connect red wire from ' K1+ ' pad on the Bigger PCB to any one pin of KCD-11 Power Switch. Connect red/black wire from ' K1- ' pad on the Bigger PCB to the another pin.

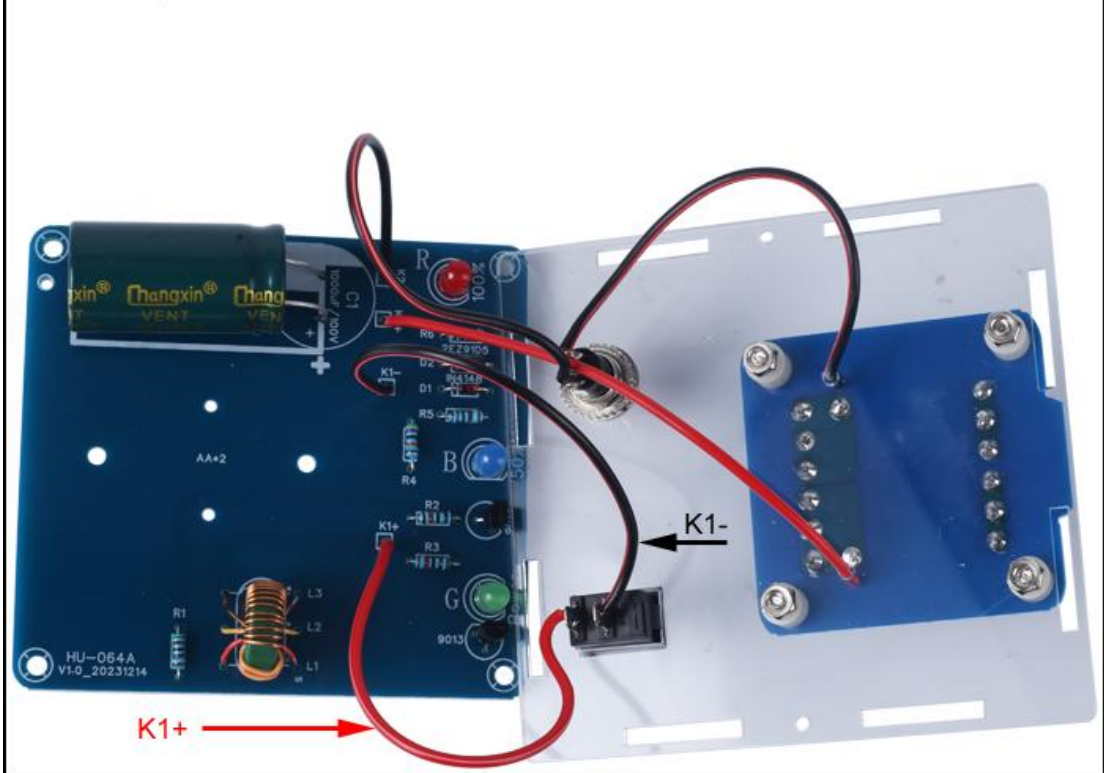

Step 24: Cut and keep about 2cm wires and fix AA*2 Battery Box on back side of the Bigger PCB. Note: red wire connect to ' + ' pad.

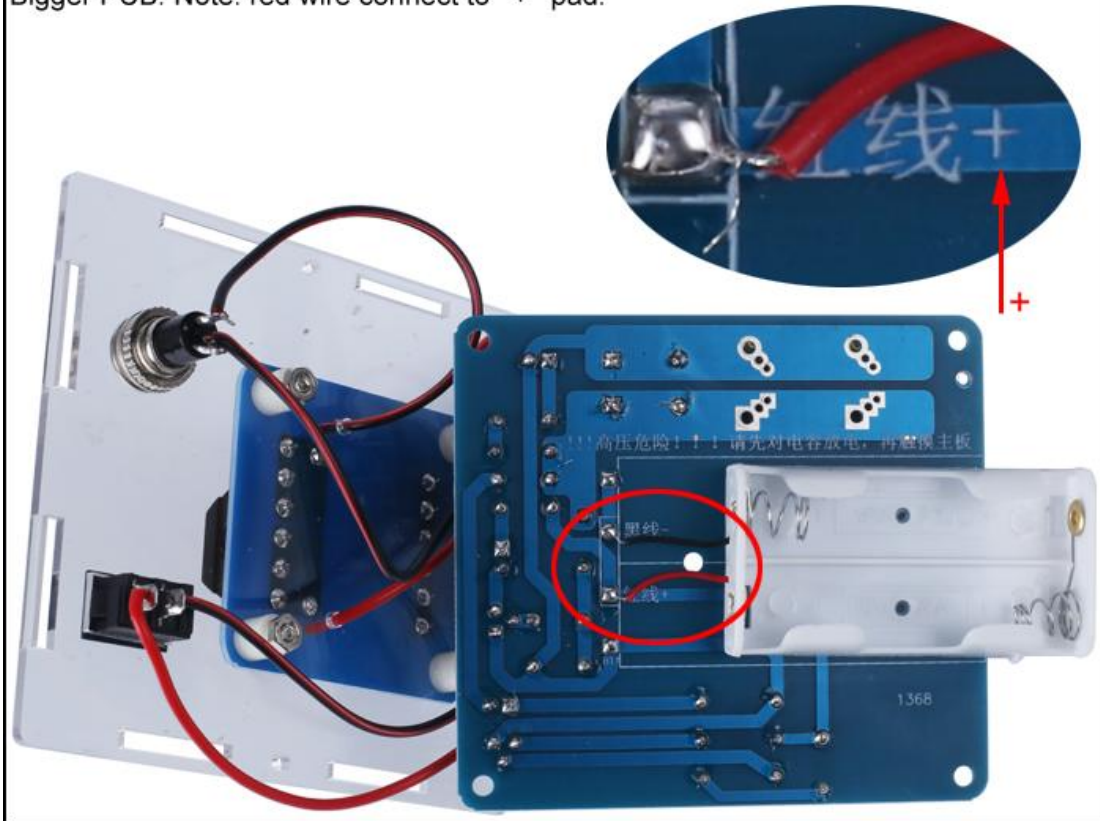

Step 25: Fix 4pcs M3*10+6mm Copper Column by 4pcs M3*5mm Screw on the Bigger PCB.

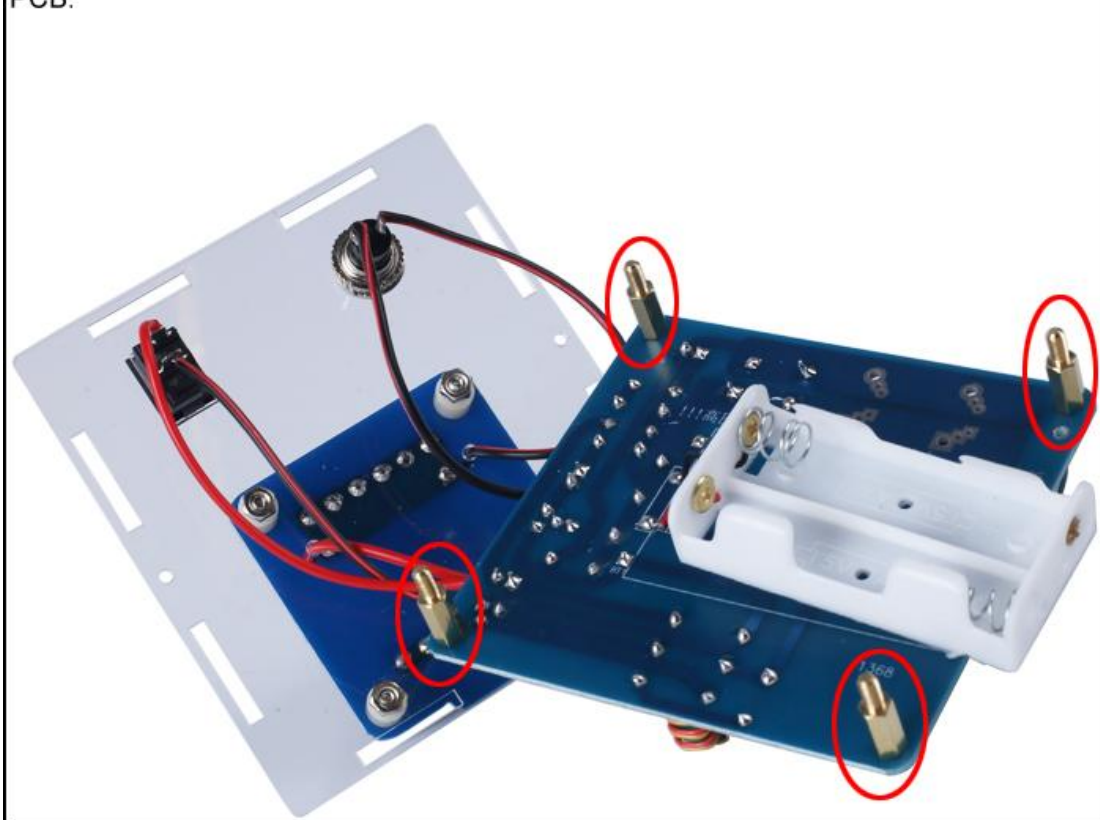

Step 26: Fix the Bottom Acrylic Board by 4pcs Metal Cap. Note: Adjusting the position of the battery box.



Step 27: Place 4pcs side Acrylic Boards as shown. Note: Adjust placement position and direction.

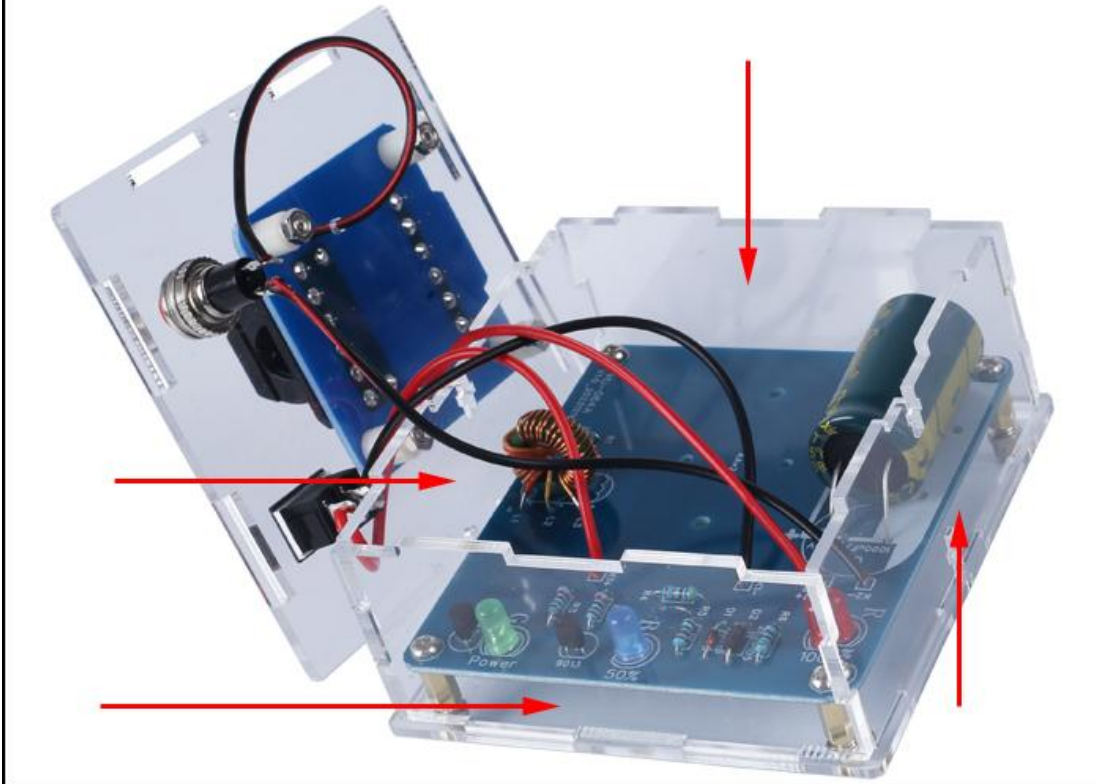

Step 28: Place the TOP Acrylic Board and align each installation hole. Then fix all Acrylic Boards by 4pcs M2*10mm Screw and 4pcs M2 Nut.

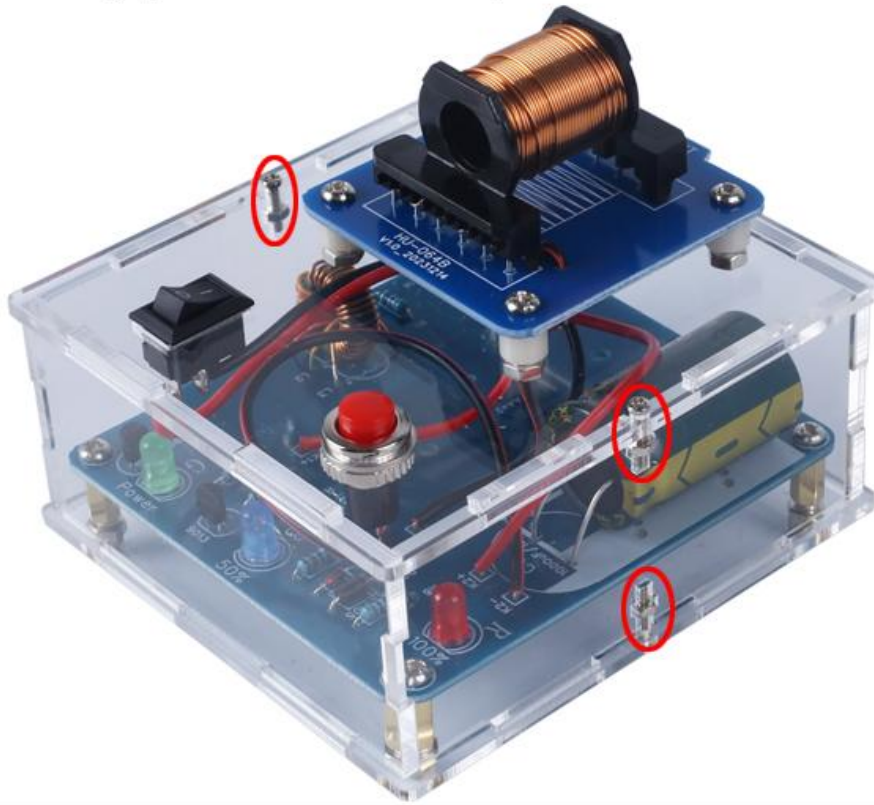

Step 29: Tear off the protective layer on the surface of the double-sided adhesive tape, and then stick it onto transparent plastic pipe and keep away about 1cm from one end.



Step 30: Insert transparent plastic pipe into Electromagnetic Coil.

