

LCD Display FM Radio Receiver DIY Kit

(Please kindly noted: battery is not included due to shipping restrict.You need to prepare it by yourself to make the receiver works)

Parameter:

- 1>.Product Name:LCD Display FM Radio Receiver DIY Kit
- 2>.Work Voltage:DC 3.0V~5.0V
- 3>.Output impedance:8ohm
- 4>.Output power:5W
- 5>.Output channel:Mono for speaker and Dual channel for earphone
- 6>.Frequency:87.0MHz~108.0MHz(Disable Campus Broadcasting Band)
- 7>.Frequency:76.0MHz~108.0MHz(Enable Campus Broadcasting Band)
- 8>.Equivalent noise: >=30dB
- 9>.Work Temperature:-40°C~85°C
- 10>.Work Humidity:5%~95%RH
- 11>.Size(Installed):118*87*27mm

Use Methods:

- 1>.Keep press AUTO button to automatically search and store the radio stations that can be listened to.
- 2>.Automatically name searchable stations like P01,P02,P02 and so on.
- 3>.Press P+ and P- to switch saved stations.
- 4>.Press V+ and V- to adjust volume from V00 to V30.
- 5>.Switch Campus Broadcasting Band: Keep press V+ and V- before power ON and then turn ON work power switch. It means enable Campus Broadcasting Band if display C1 on LCD. It means disable Campus Broadcasting Band if display C0 on LCD.Available after restart.
- 6>.Enable backlight mode: Keep press P+ and P- before power ON and then turn ON work power switch. It means keep backlight ON if display B1 on LCD. It means the backlight will turn OFF after 20second if display B0 on LCD(This is the power saving mode).Available after restart.
- 7>.It can output audio from speaker and earphone jack. The speaker of the module does not work when the earphone is connected.

Component List:

NO.	Component Name	PCB Marker	Parameter	QTY
1	LM4863	U1	SOP-14	1

2	3.5mm Audio Socket	J5	5Pin	1
3	Monolithic Capacitor	C2	0.1uF 104	1
4	Electrolytic Capacitor	C1	1uF 50V	1
5	Metal Film Resistor	R2,R3	10Kohm	2
6	Metal Film Resistor	R1	39Kohm	1
7	FM Audio Receiver	J4	41*22mm	1
8	Black Button	S1-S5	6*6*20mm	5
9	Micro USB Socket	J2	SMD	1
10	Antenna	ANT	80mm-255mm	1
11	Female Pin	J4	16Pin	1
12	Self-locking Button	S6	8*8mm	1
13	Self-locking Button Cap	S6	Red	1
14	18650 Battery Box	J1,J3		1
15	Male Pin		7Pin	1
16	Charging Module	J7	26*18mm	1
17	Cable		15cm	2
18	Speaker	SP1	8ohm 5W	1
19	Acrylic Shell			6
20	Copper Pillar		M3*15mm	4
21	Screw		M3*10mm	4
22	Screw		M3*6mm	14
23	Nut		M3	12
24	PCB			1

Note:Users can complete the installation according to the PCB silk screen and component list.

Schematic Diagram:

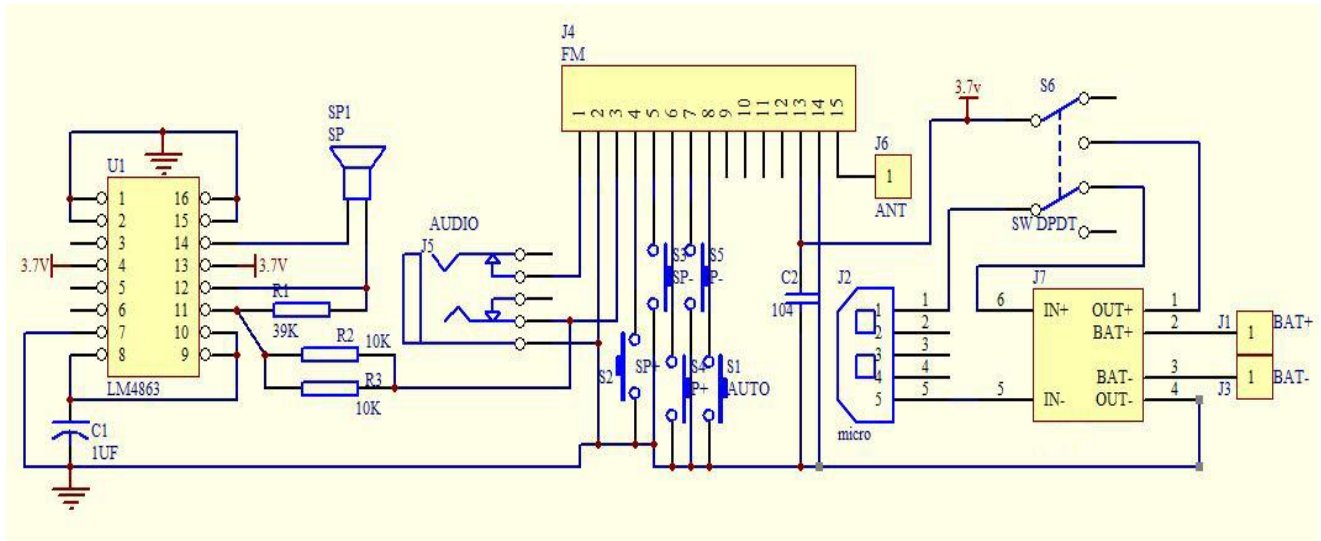

Note:

- 1>.It cannot receive radio while it is charging.
- 2>.It is a wireless module. So do not use it in an environment with signal interference.
- 3>.Input charging voltage form micro USB on the bigger PCB.

Installation Tips:

- 1>.Please prepare the welding tool at first.
- 2>.Please be patient until the installation is complete.
- 3>.The soldering iron can't touch the components for a long time(1.0 second), otherwise it will damage the components.
- 4>.Pay attention to the positive and negative of the components.
- 5>.Strictly prohibit short circuit.
- 6>.User must install the LED according to the specified rules.Otherwise some LED will not light.
- 7>.Install complex components preferentially.
- 8>.Make sure all components are in right direction and right place.
- 9>.It is strongly recommended to read the installation manual before starting installation!!!
- 10>.Please wear anti-static gloves or anti-static wristbands when installing electronic components.

Installation Steps(Please be patient):

- Step 1: Install 1pcs 39Kohm Metal Film Resistor at R1.

Step 2: Install 2pcs 10Kohm Metal Film Resistor at R2,R3.

Step 3: Install 1pcs SOP-14 IC LM4863 at U1. There is a mark on one end of the IC and there is a mark on PCB where the IC can place on. These two marks are corresponding to each other and are used to specify the installation direction of the IC Socket.

Step 4: Install 1pcs micro USB socket at J2.

Step 5: Prepare 6pcs pin header.

Step 6: Install 1pcs Charging Module at J7 and fix by 6pcs pin header.

Step 7: Remove black fixed block from 6pcs pin header and fix Charging Module.

Step 8: Install 1pcs 0.1uF Monolithic Capacitor at C2.

Step 9: Install 1pcs 1uF 50V Electrolytic Capacitor at C1. Pay attention to distinguish between positive and negative. The Longer pin is positive pole.

Step 10: Install 1pcs 3.5mm Audio Socket at J5.

Step 11: Cut a pin from 16Pin Female Socket.

Step 12: Install Female Socket at FM. Pay attention to the direction of the cut pin.

Step 13: Install 1pcs Self-locking Button at S6.

Step 14: Install 5pcs 6*6*20mm Black Button at S1-S5.

Step 15: Install 1pcs Self-locking Button Cap on Self-locking Button.

Step 16: Install 1pcs Antenna at ANT. Note that the antenna should be installed on the front of the PCB.

Step 17: Install 1pcs 18650 Battery Box at J1,J3. Pay attention to the positive and negative. Red wire is positive pole.

Step 18: Install 2pcs 15cm black Cable on speaker.

Step 19: Connect speaker to PCB at SP. The speaker does not distinguish between positive and negative.

Step 20: Install 1pcs FM Audio Receiver on Female pins. Pay attention to the direction of the cut pin.

Step 21: Tear off the protective film on the surface of the acrylic shell.

Step 22: Install 4pcs M3*15mm Copper Pillar and 4pcs M3*10mm Screw on Acrylic bottom plate.

Step 23: Fixed speaker on acrylic bottom plate by 4pcs M3*6mm Screw.

Step 24: Install 3pcs M3*6mm Screw and 3pcs M3 Nut on Acrylic bottom plate. Note that the wire should not be placed between the PCB and the acrylic.

Step 25: Fixed main PCB on acrylic bottom plate by 3pcs M3 Nut. Note that the wire should not be placed between the PCB and the acrylic.

Step 26: Adjust the position of the battery box. Do not place the wires under the battery box. The wires can be moved to both ends of the battery box.

Step 27: Fix other acrylic plate by 6pcs M3*6mm Screw and 6pcs M3 Nut.

Step 28: Connect to power supply and enjoy the effect.

11.Installation step instruction:

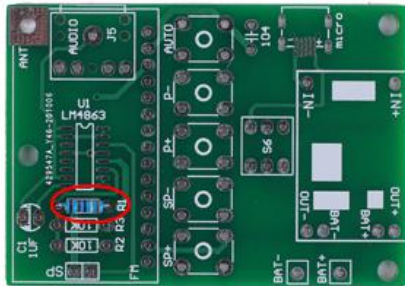

Step 1: Install 1pcs 39Kohm Metal Film Resistor at R1.

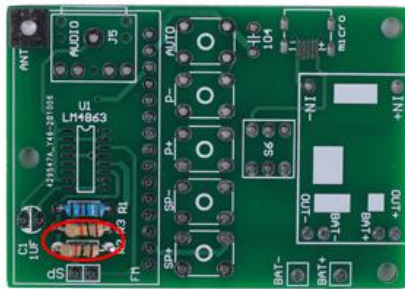

Step 2: Install 2pcs 10Kohm Metal Film Resistor at R2,R3.

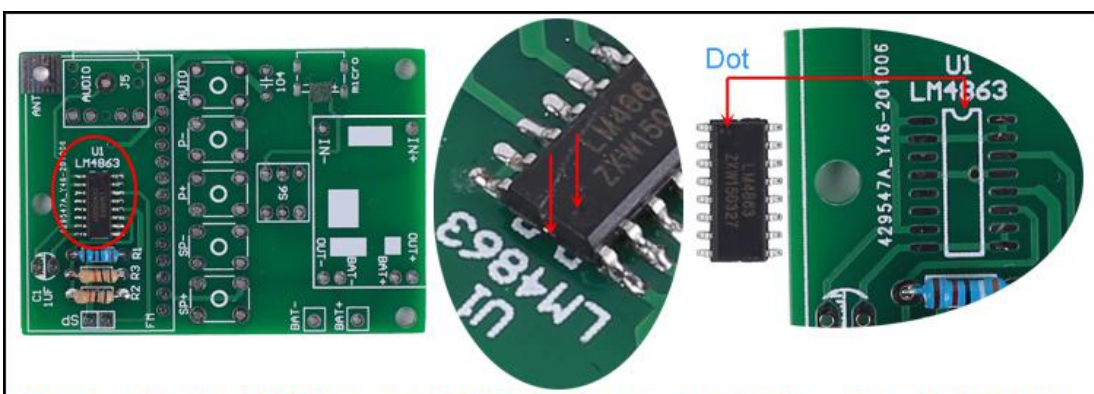

Step 3: Install 1pcs SOP-14 IC LM4863 at U1. There is a mark on one end of IC and there is a mark on PCB where IC can place on. These two marks are corresponding to each other and are used to specify the installation direction of the IC Socket.



Step 4: Install 1pcs micro USB socket at J2.



Step 5: Prepare 6pcs pin header.

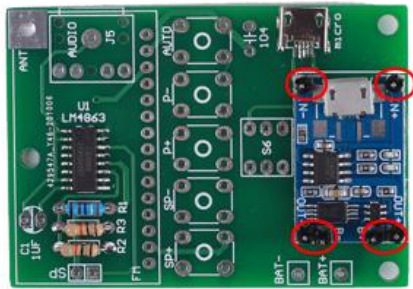

Step 6: Install 1pcs Charging Module at J7 and fix by 6pcs pin header.



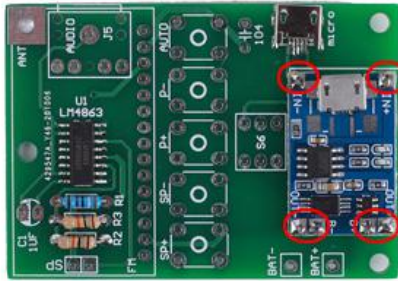

Step 7: Remove black fixed block from 6pcs pin header and fix Charging Module.

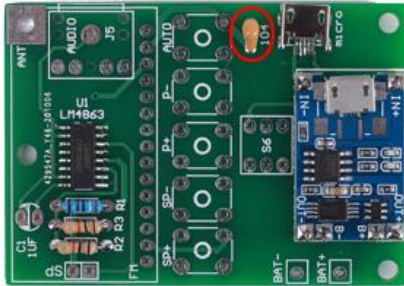

Step 8: Install 1pcs 0.1uF Monolithic Capacitor at C2.

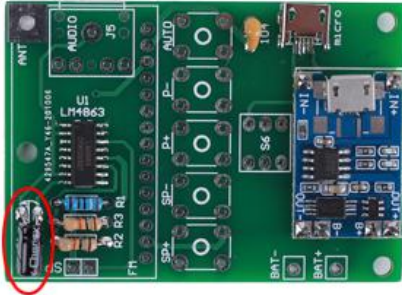

Step 9: Install 1pcs 1uF 50V Electrolytic Capacitor at C1. Pay attention to distinguish between positive and negative. The Longer pin is positive pole.

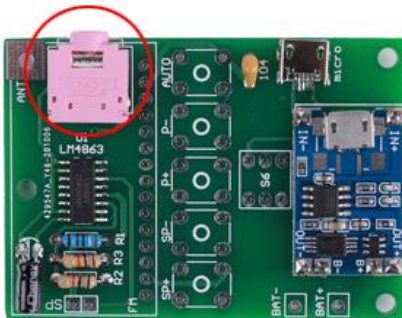

Step 10: Install 1pcs 3.5mm Audio Socket at J5.

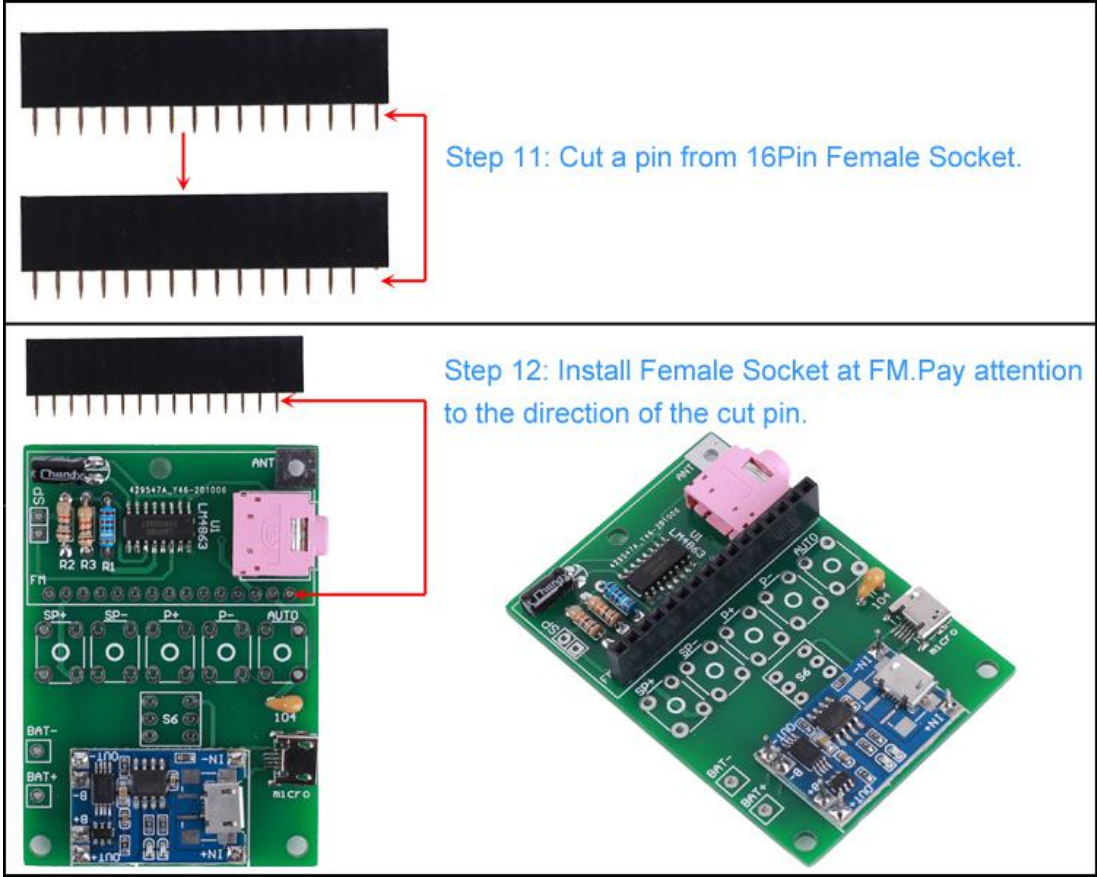

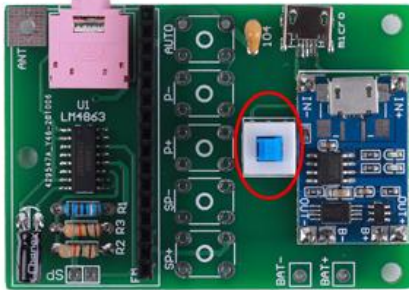

Step 13: Install 1pcs Self-locking Button at S6.

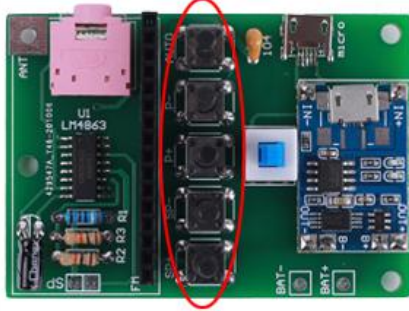

Step 14: Install 5pcs 6*6*20mm Black Button at S1-S5.



Step 15: Install 1pcs Self-locking Button Cap on Self-locking Button.



Step 16: Install 1pcs Antenna at ANT. Note that the antenna should be installed on the front of the PCB.

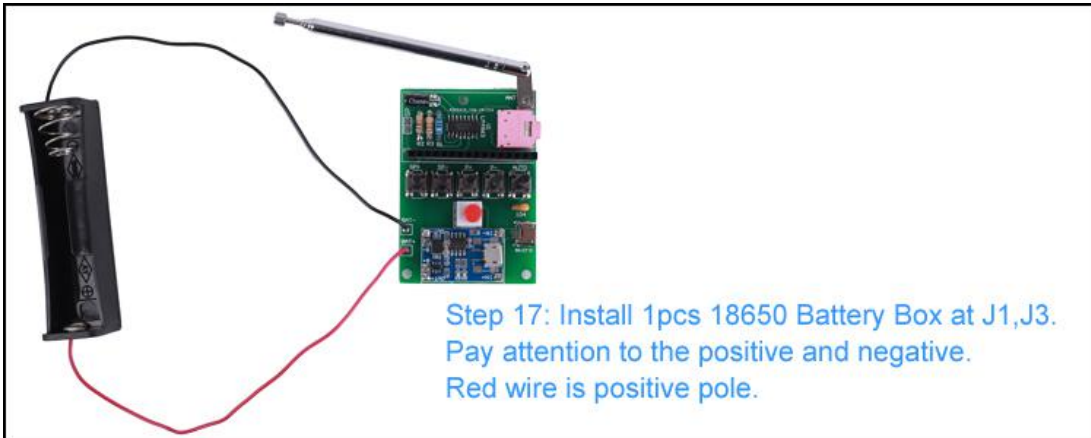





Step 21: Tear off the protective film on the surface of the acrylic shell.



Step 22: Install 4pcs M3*15mm Copper Pillar and 4pcs M3*10mm Screw on Acrylic bottom plate.



Step 23: Fixed speaker on acrylic bottom plate by 4pcs M3*6mm Screw.



Step 24: Install 3pcs M3*6mm Screw and 3pcs M3 Nut on Acrylic bottom plate.
Note that the wire should not be placed between the PCB and the acrylic.



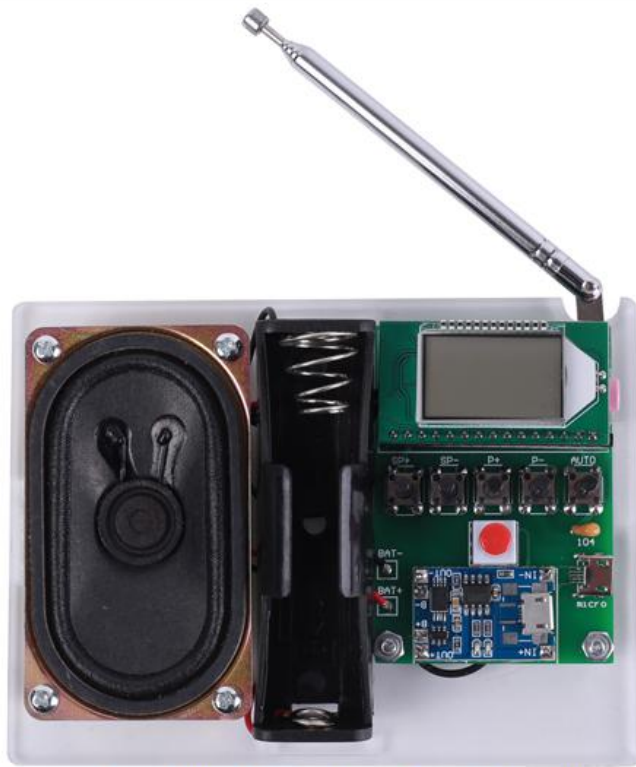

Step 26: Adjust the position of the battery box. Do not place the wires under the battery box. The wires can be moved to both ends of the battery box.

Step 27: Fix other acrylic plate by 6pcs M3*6mm Screw and 6pcs M3 Nut.



Step 28: Connect to power supply and enjoy the effect.