





Self-locking, Interlocking, Jog (default self-locking)





Self-locking mode
4 devices are individually controlled and do not affect each other



Interlock mode
[4 devices open one intelligently at the same time]
When a device is turned on, other devices are automatically turned off at the same time



Jog mode
[The jog duration can be customized]
Turn on the device and automatically keep for 0.5 to 3600 seconds, then automatically turn off





4 Channels

Control up to 4 devices simultaneously

Voice Control

Enjoy Fully Hands-free Experience with your Alexa and Google Home Assistant.

"Alexa, turn on the light"

ok!



Timer Schedule

Set a schedule in the app to turn on and off your lights according to your own living habits.

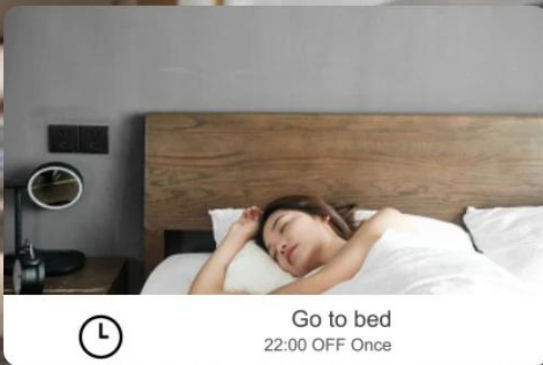

Make your home smarter

4CH Zigbee Smart Switch, it can be connected to most electrical appliances and lightings

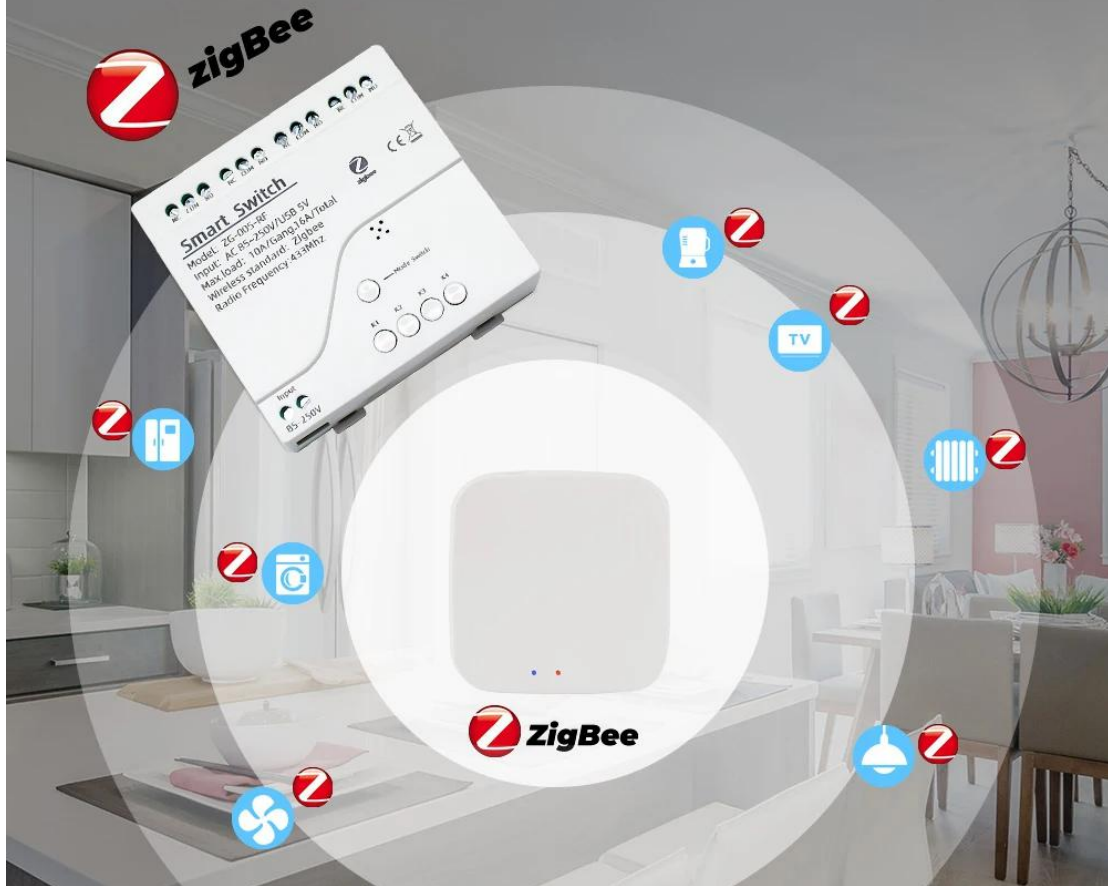

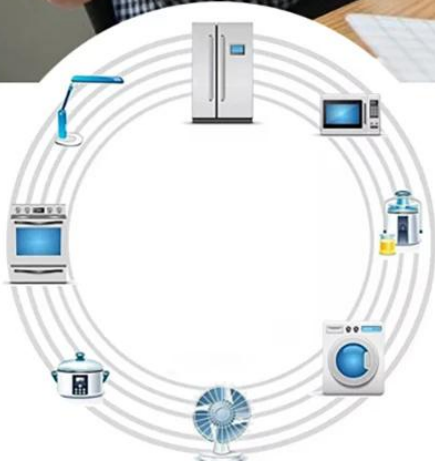

APP Remote Control

Just tap on eWeLink App to turn on a light anytime and anywhere.

Self-locking Switch Application Scenarios

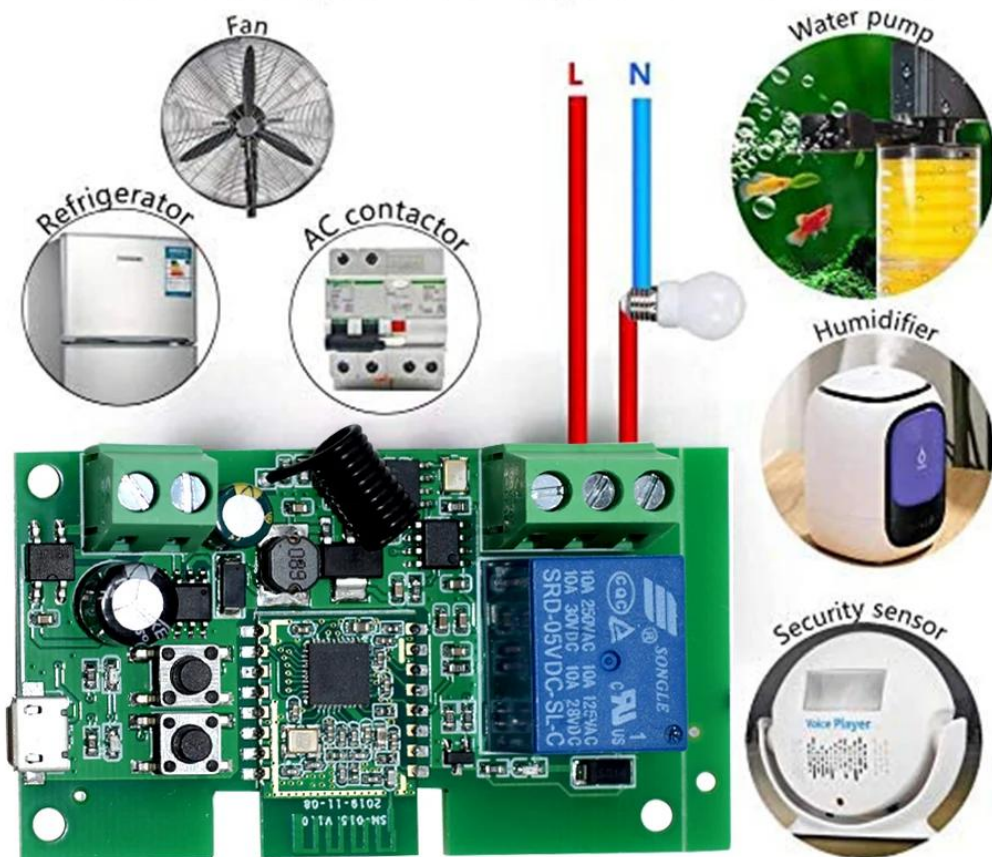

Momentary Button (Delay time 1s) Application Scenarios

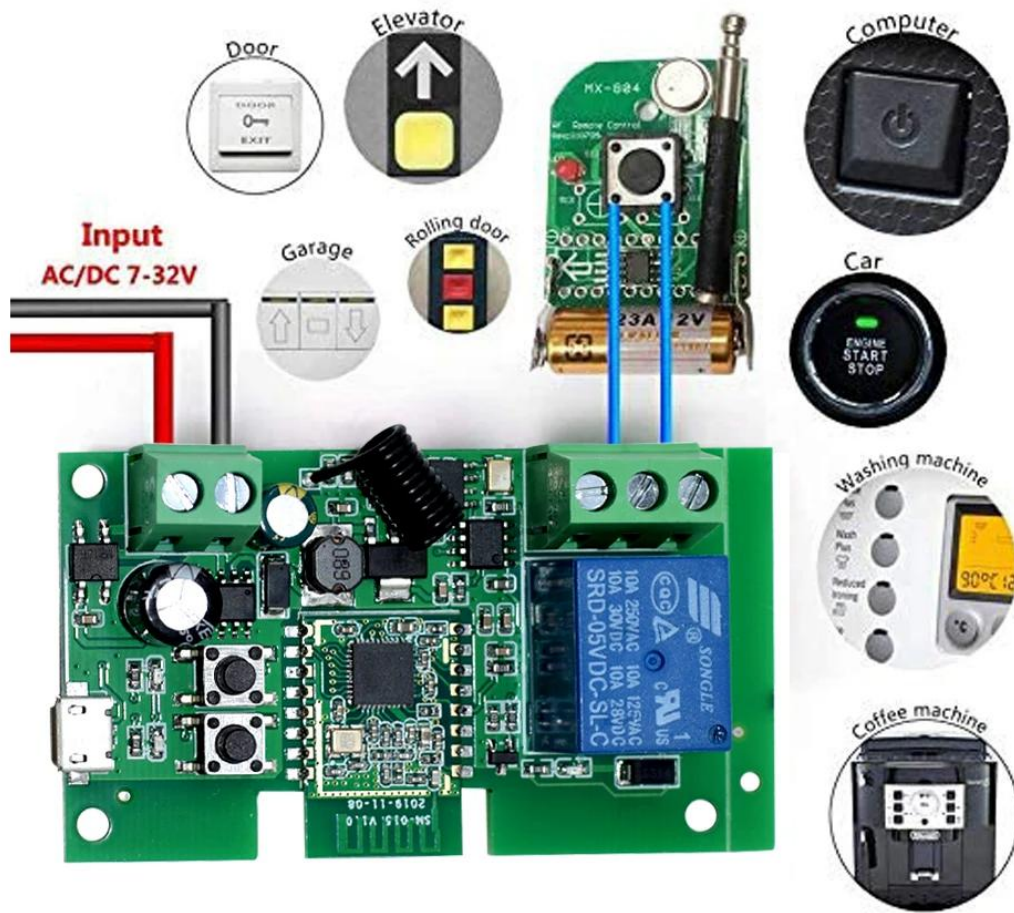

THREE WORKING MODES ZIGBEE 4 CHANNEL RELAY

DC 5/12/32V RF433 Receive 10A Relays 4CH Zigbee Smart Light Switch Module Work with Alexa Google Assistant,Tuya Smart Life

E 0 9 0 4

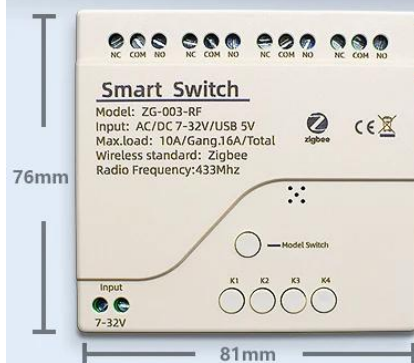

PRODUCT FEATURE

Working temperature: -20°C-70°C
Max.Current: 2200W/10A/gang
Input Voltage: DC/AC 7V-32V
Wireless Standard: Zigbee
Size: 69*41*20mm

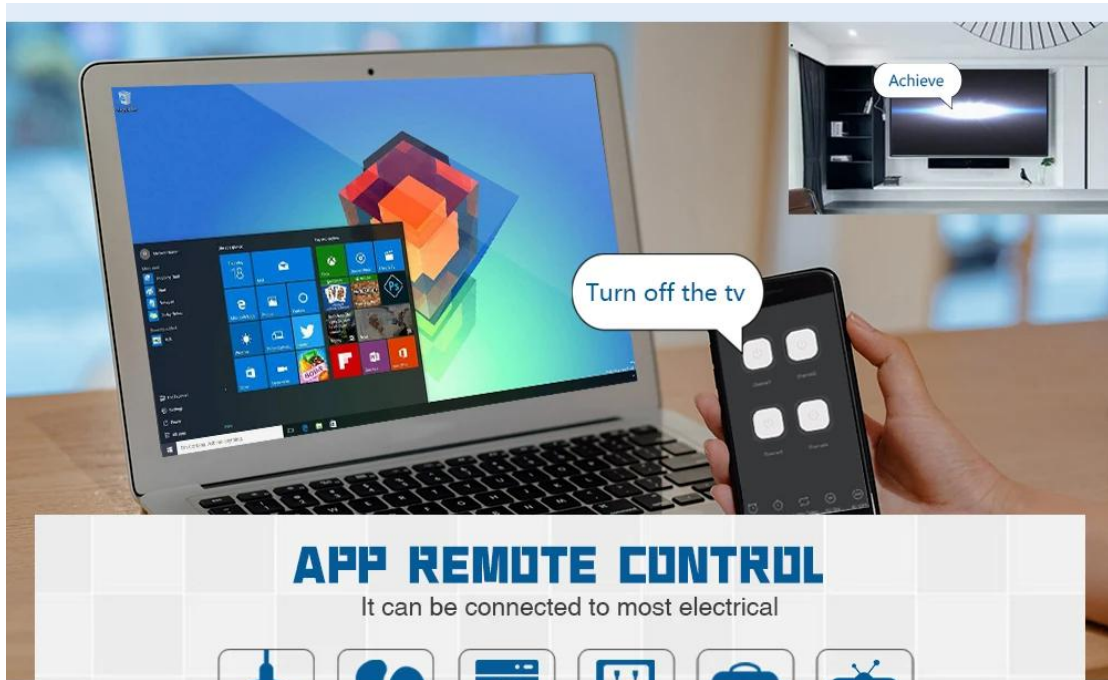

APP REMOTE CONTROL

It can be connected to most electrical



lamp



fan



Washer



Cooler



Rice cooker



Television

01 Go to the app market to Download tuya app



02 Zigbee gateway hub, can be connect to Alexa

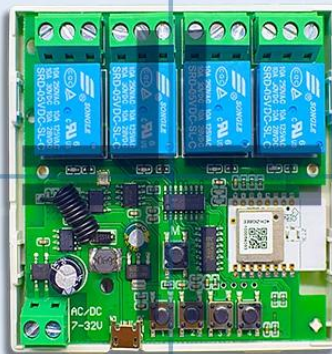

1. 433MHz remote control



03 You could voice command the connected device

04 two different control methods

2. WIFI



ONE SWITCH CONTROLS MULTIPLE DEVICES

control up to four different
devices simultaneously



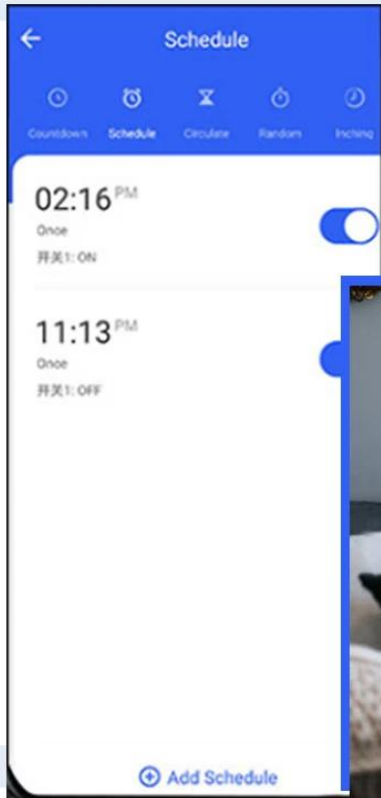

TIMER FUNCTION

turn your lights on of off regularly

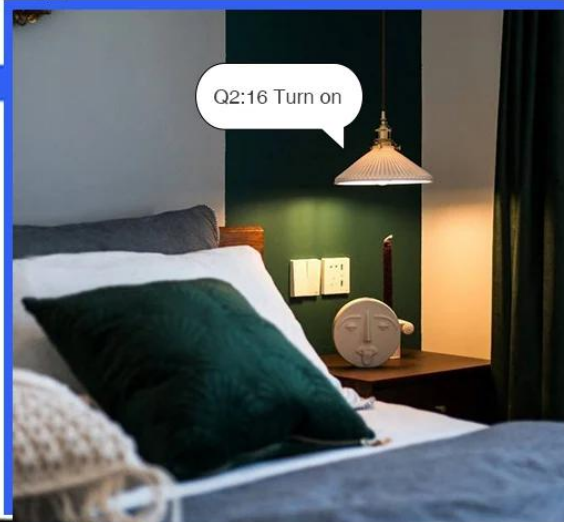

Quick to Use

1



Download Alexa APP

2



Connect with Alexa

3



Power on

4



Add devices

Wireless WIFI

Plug and Play

Intimate wall-mounted design makes it easier for WIFI to expand anywhere, anytime. Works with any standard router or gateway.

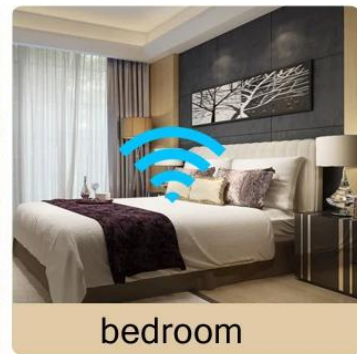
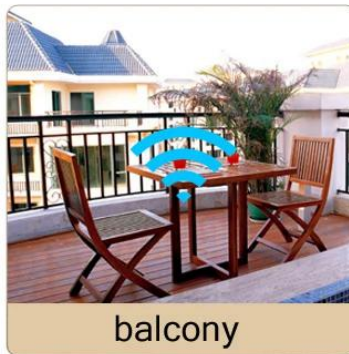
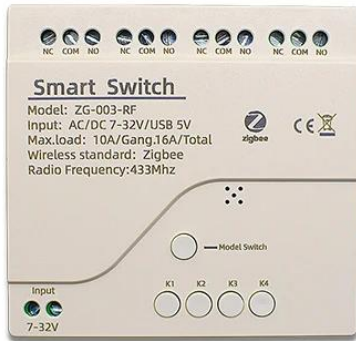



Voice control



ZigBee
3.0

APP control



Wide transmission range



ZigBee Alliance



Remote Control

Control your home curtains anytime, anywhere





Simple Voice Control

Speak to Alexa and it will perform your command

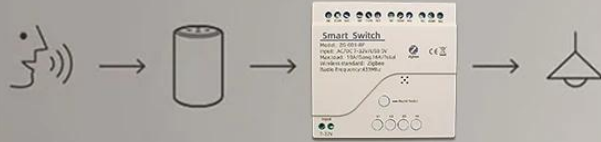

"Alexa, turn on the light."

"Okay."



Scimagic-RC



New Arrival!





tuya



4CH AC / DC 7-32V / USB 5V

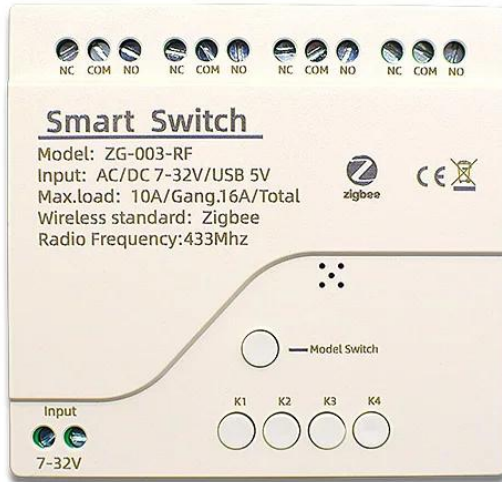
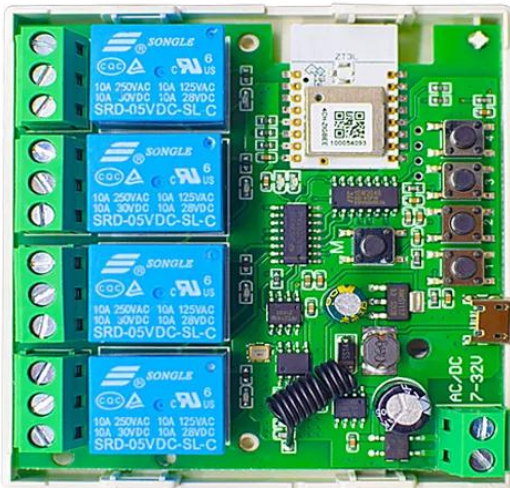

Shell (free)



4CH AC 85-250V / USB 5V



Shell (free)

Wiring Diagram

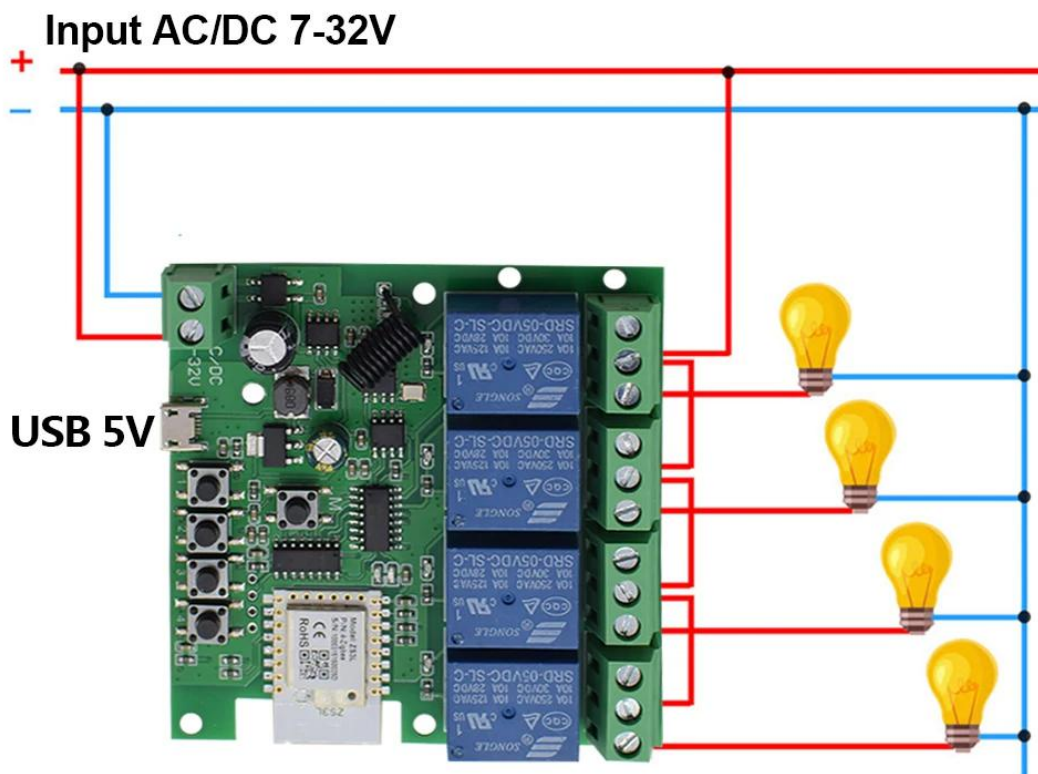

Motor Wiring Diagram

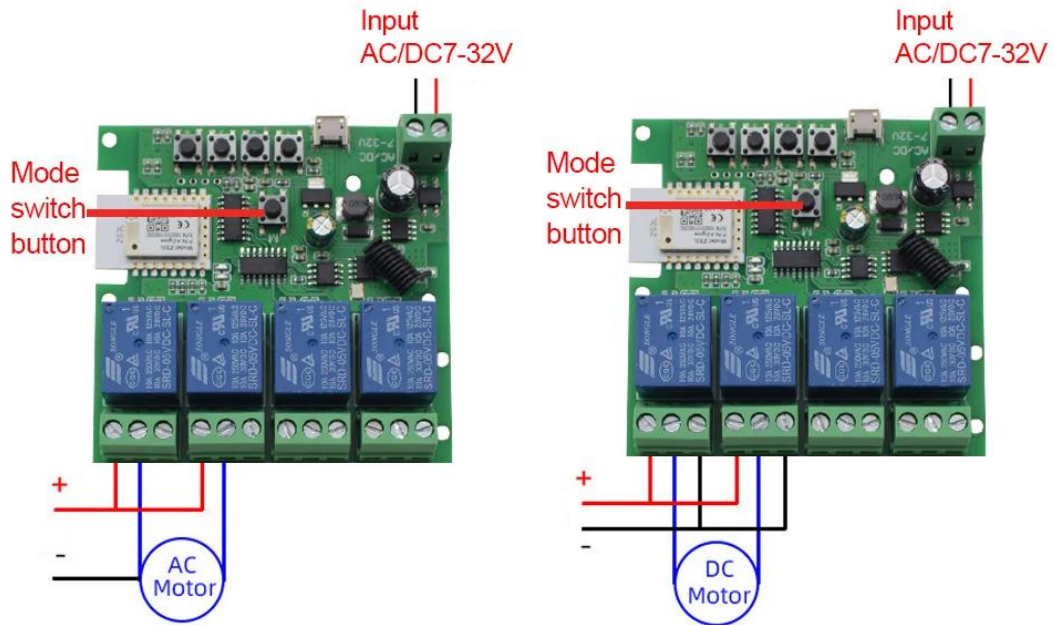

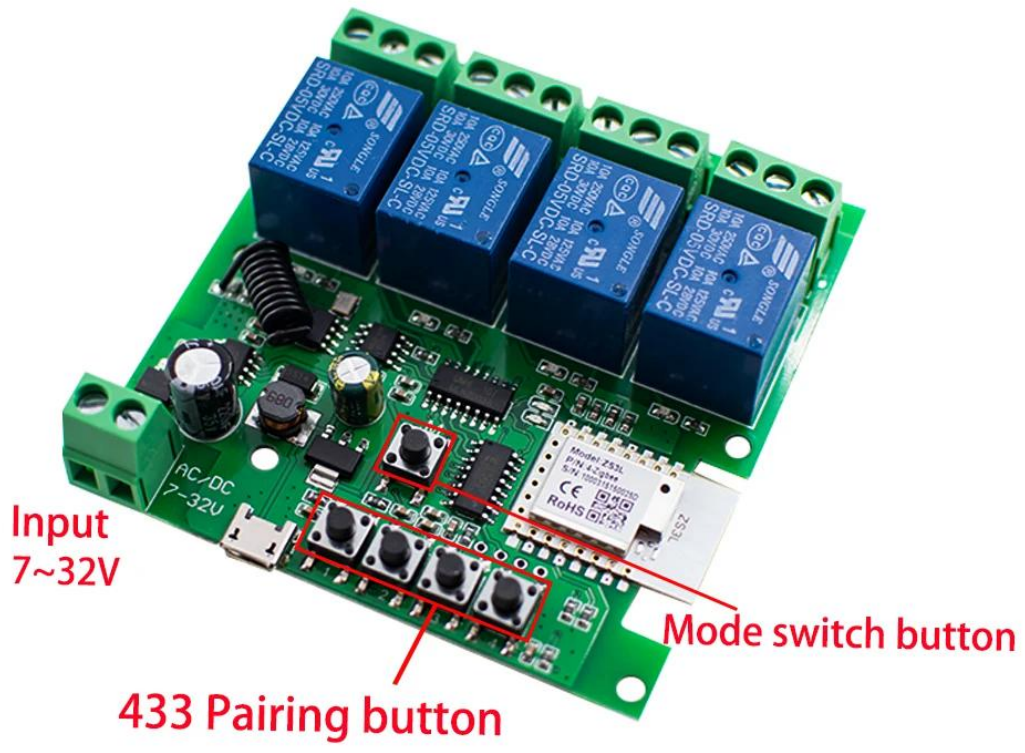

Zigbee Three Mode Switch

Model: ZG- 003
Model: ZG- 003-RF

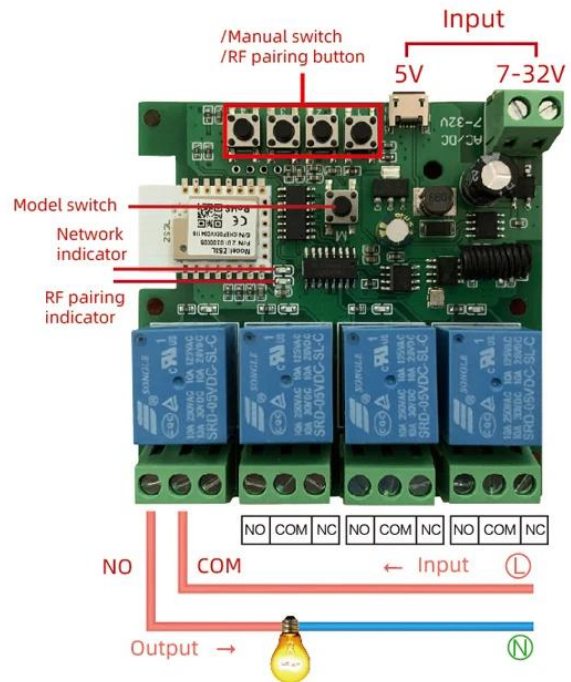

Parameters:

Input voltage: DC/AC 7V~32V
Max.Current:2200W/10A/gang
Wireless Standard:Zigbee
Working temperature: -20°C~70°C
Size: 69*41*20mm

Checklist before using the device

- You need to have a Zigbee gateway.
Try to be close to the Zigbee gateway when pairing.

Add device flow to mobile APP

Here is an example of adding a device to tuya Zigbee gateway

- 1 After installation, power on the device and confirm that the device's network indicator is flashing Status, click the Zigbee gateway card. (If the device network indicator is not flashing, you can press and hold any manual Switch for 8 seconds to reset the device)



- 2 Click "Add subdevice" .



- 3 Wait for about 1 minute until the device is found, then click "Done" .



- 4 Add successfully, return to the main interface of tuya, you can see the newly added device.

- 5 When the device's network indicator light is on, remote control can be performed.

APP Function

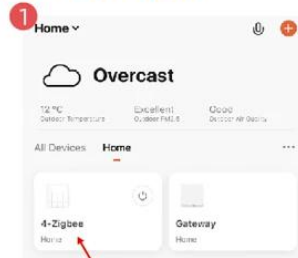

Tip here to enter the full function operation interface.

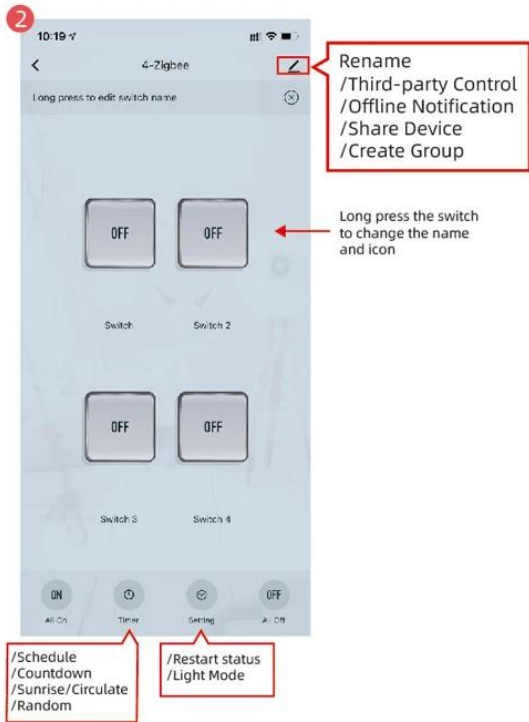

Remote control matches the code

Matching:

- ① hold the manual switch for 3 seconds until RF pairing indicator(blue light)is on.
- ② then long press the remote control buttons .
- ③ loosen the remote control buttons,matching success.



Clear code:

Long press the manual switch for 15 seconds (RF pairing indicator is always on), loosen the manual switch until RF pairing indicator is off.

* note: the matching/clear code method is only available with RF function switch/module reference.

TROUBLESHOOTING

Solutions for the failure of product matching and offline:

Enter the homepage of App,click the icon in the lower right corner of the interface to enter.

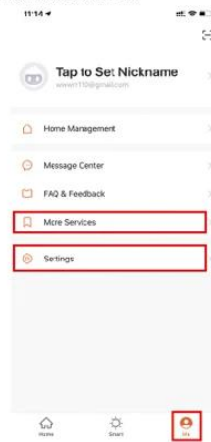



tuya



wifi



RF

2CH AC/DC 7-32V / USB 5V



+



Shell(free)



tuya



2CH AC 85-250V / USB 5V



+



Shell(free)



tuya



wifi



RF

1CH AC/DC 7-32V / USB 5V



+



Shell(free)



1CH AC 85-250V / USB 5V



+



Shell(free)