

# Outdoor Energy Storage Power Station

## 2500W UK Version (230V 50Hz)

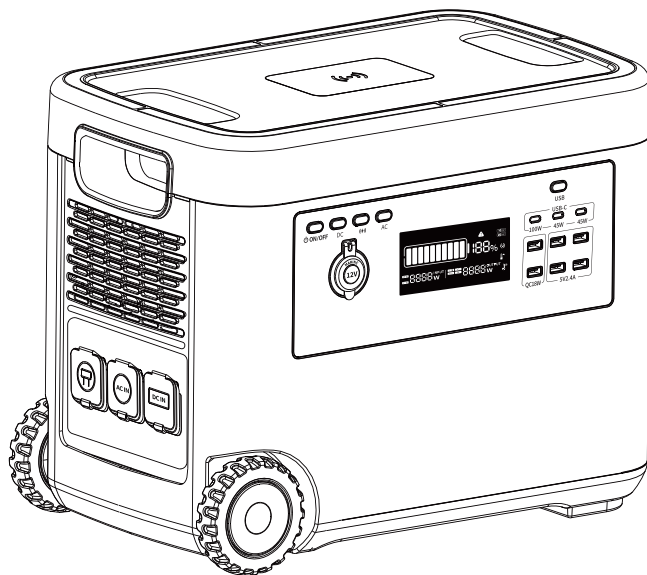

Model:D5

**User Manual**

## Disclaimer

Please read the User Manual of this product to ensure proper use after full understanding before use. After reading the Manual, please keep it safe for future reference. If you do not use this product correctly, you may cause injury to yourself or others, product damage or property loss. By using this product, you are deemed to have understood, recognized, and accepted all terms and contents of this document. The user acknowledges that he/she is responsible for all consequences resulting from his/her actions. The Seller shall not be liable for any loss arising from the user's failure to use the products in accordance with the User Manual.

The Company reserves the right to interpret this document and all related documents of the product by complying with the laws and regulations. Please visit the official website for the latest product information if it is updated, changed or terminated without prior notice.

## Contents

1.Parameter specification	1
2.Safety guidelines	2
3.Beginner guide	3
3.1 Appearance introduction	4
3.2 Introduction of display icon	5
3.3 Instructions	6
3.4 AC charging	7
3.5 Solar charging	8
3.6 Car charger	9
3.7 UPS function	10
4.FAQ	11
5.Package contents	12
6.How to maintain and repair	13

# 1.Parameter specification

## Basic parameters

Name	Outdoor power supply (2500W)
Model	D5
Net weight	About 25kg
Size of host	470.5x289x366mm
Energy capacity of battery pack	45Ah ,48V(2160wh)
PSE Certification standard	UN38.3 CE FCC RoHS MSDS PSE
Quality guarantee	2 years

## Output specification

AC output pure sine wave	230VAC 2500W (peak: 4000W), 50Hz
USB-A (output of X4)	5V≡2.4A, maximum power: 12W (per circuit)
USB-A (output of x2)	5V≡3A, 9V≡2A, 12V≡1.5A, maximum power: 18W (per circuit)
USB-C (output of x2)	5V≡3A, 9V≡3A, 12V≡3A, 15V≡3A, 20V≡2.25A, maximum power: 45W (each circuit)
USB-C (output of x1)	5V≡3A, 9V≡3A, 12V≡3A, 15V≡3A, 20V≡5A, maximum power: 100W (per circuit)
Car charging output	12V≡8.3A, maximum Power: 100W
Wireless charging output	15W

## Input specification

AC input power	Maximum power of fast charge: 1500W
AC input voltage	230V MAX,50Hz
Solar charging input	11V-50V 12A MAX, maximum 400W
Input of car charging	Support 12V/24V, default input current: 15A

## Battery specification

Cycle life	After 2000 cycles, the remaining capacity is still 80%+
Protection type	High temperature protection, low temperature protection, over discharge protection, over charge protection, overload protection, Short circuit protection, overcurrent protection

## Operating temperature

The best ambient temperature:	20°C - 30°C
Ambient temperature of discharge:	-10°C - 40°C
Ambient temperature of charging:	0 °C - 40°C
Ambient temperature of storage:	-10°C-40°C (optimum: 20°C-30°C)
Charging time:	about 6 hours for 400W solar panel (charging time is determined by photovoltaic), about 1.6 hours for mains electricity, about 17 hours for car charging

## 2.Safety guidelines

### 2.1 Instructions

1. Do not put the product near the heat source, such as fire source or heating furnace.
2. Do not allow the product to contact any liquid, do not immerse the product in water or wet it, and do not use this product in the rain or wet environment.
3. Do not use the product in the environment of strong static electricity or magnetic field.
4. Do not disassemble or pierce the product with sharp objects in any way.
5. Do not use wire or other metal objects to short-circuit the product.
6. Do not use non-official parts or accessories. For the replacement (if necessary), please go to the official sales channel for relevant purchase information.
7. Please follow the ambient temperature specified in this User Manual strictly when using this product. If the temperature is too high, the battery may catch fire. If the temperature is too low, the product performance will be reduced seriously, or even cannot meet the requirements of normal use.
8. Do not stack other heavy objects on the product.
9. It is forbidden to block the fan forcibly during use, or keep the product in an unventilated or dusty space.
10. Please avoid collision, fall and violent vibration. In case of severe external impact, please turn off the power immediately and stop using. Please fix it properly during transportation to avoid vibration and impact.
11. If the product accidentally falls into water during use, please place it in a safe and open area away from the product until it is completely dry. The product dried shall not be used again and shall be disposed of properly as described in Section 2.2 of this article. If the product is on fire, please use the fire extinguishing equipment in the following recommended order: water or water mist, sand, fire blanket, dry powder, carbon dioxide fire extinguisher.
12. If there is dirt on the interface of this product, please clean with a dry cloth.
13. Please place the product carefully to avoid damage caused by tipping. If the product is tipped over and seriously damaged, please shut it down immediately, place the battery in an open area away from combustibles and people, and scrap the battery according to local laws and regulations.
14. Please keep this product out of reach of children and pets to reduce risk.

### 2.2 Discard

1. If conditions permit, please be sure to discharge the battery completely, and then put the product in specified battery recycling bin. This product contains batteries, which are dangerous chemicals, so it is strictly prohibited to discard them in ordinary dustbins. Please follow local laws and regulations on battery recycling and disposal for the details.
2. If the battery cannot be discharged completely due to the fault of the product, please do not discard the battery directly in the battery recycling bin, and contact a professional battery recycling company for further processing.
3. The battery will not start after overdischarge. Please dispose it as discarded.

## 3. Beginner guide

### 3.1 Appearance introduction

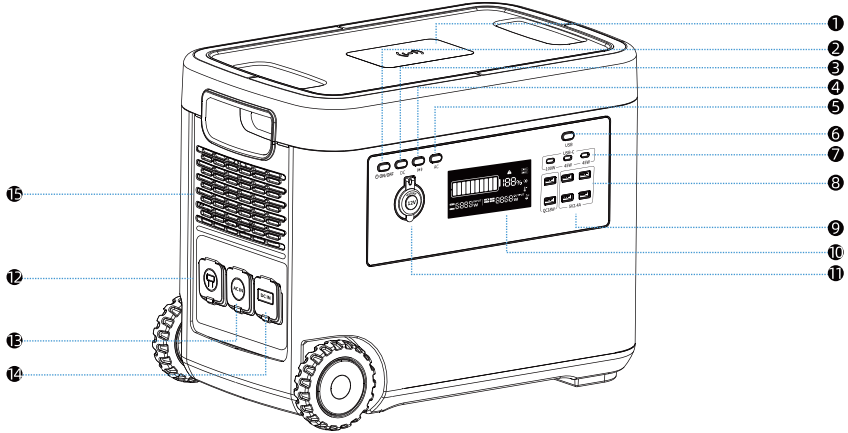

- |   |                                    |                                    |
|---|------------------------------------|------------------------------------|
| ① Output port OF Wireless charging          | ⑥ USB output switch                | ⑪ 12V output port of car charger   |
| ② Main power button                         | ⑦ USB-C output port                | ⑫ Overload protector of AC input   |
| ③ Button of DC output switch                | ⑧ USB-A output port                | ⑬ Input port of AC charging        |
| ④ Button of wireless charging output switch | ⑨ USB-A output port of fast charge | ⑭ Input port of solar/car charging |
| ⑤ Button of AC output switch                | ⑩ LCD                              | ⑮ Intake of air cooling system     |

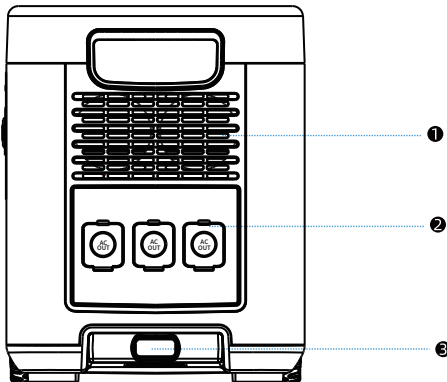

- |                                |
|--------------------------------|
| ① Outlet of air cooling system |
| ② AC output socket             |
| ③ Handle of pull rod           |

## 3.2 Introduction of display icon

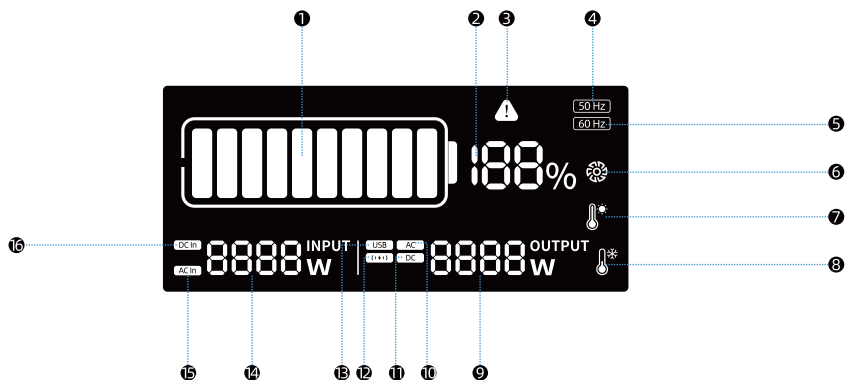

- ① Power display bar
- ② Battery percentage
- ③ Overload/short circuit protection tips
- ④ AC output of 50Hz
- ⑤ AC output of 60Hz
- ⑥ Air cooling system on
- ⑦ High temperature protection tips
- ⑧ Low temperature protection tips
- ⑨ Display of output power
- ⑩ AC output (on)
- ⑪ DC output (on)
- ⑫ Wireless charge output (on)
- ⑬ USB output (on)
- ⑭ Display of input power
- ⑮ AC charging indicator
- ⑯ Solar charging indicator

## 3.3 Instructions

### Turn on, turn off and turn on the LCD screen



Press 1s to turn on/off the machine

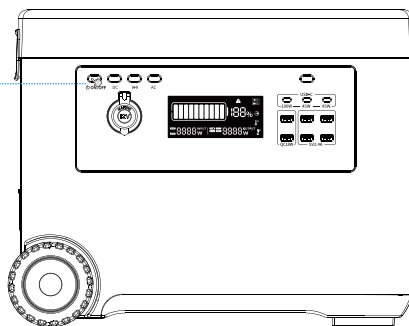

1. Press the OFF/ON button for 1 second to turn on the power-on display. Press the OFF/ON button for 1 second to turn off the device.
2. When all output is off, the product will automatically shut down if there is no operation within 1 minute.

## USB output

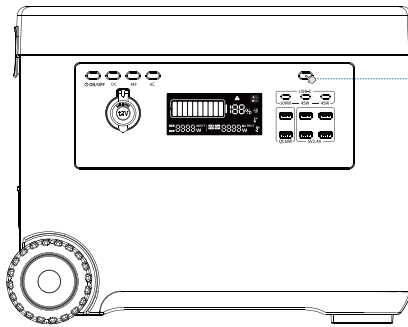

Click USB power switch to turn on USB output, and then click USB power switch to turn off.

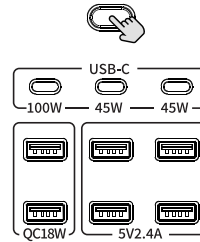

1. When the device is turned on, please click the USB switch to turn on the USB port, and then click the USB switch again to turn off the USB output.
2. When the USB is on and there is no load on the USB output port, the USB will automatically shut down the output 8 hours later, and the product will automatically shut down.

## 12V output



DC

Click DC switch for USB output, and then click DC output power switch to turn off.

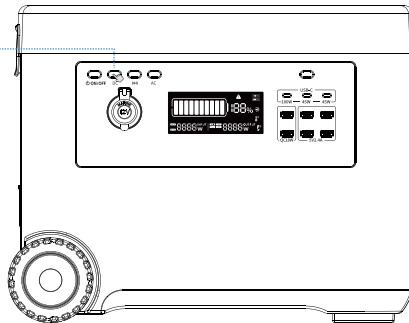

1. Click the DC switch to turn on the DC port for output in startup state, and then click the DC switch again to turn off the DC output.
2. When the DC is on and the DC output port is free of any load, the DC will automatically shut down the output 8 hours later and the product will automatically shut down.



## Output of wireless charging



Click wireless charging switch for output, and then click wireless charging switch to turn off.

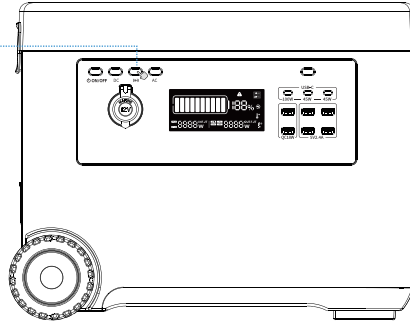

1. Click the wireless charging switch to turn on the output of the wireless charging port in startup state, and then click the wireless charging switch again to turn off the output of the wireless charger.
2. When the wireless charger is open and the output port of the wireless charger is free of any load, the wireless charger will automatically close the output and the product will automatically shut down after 8 hours.

## AC output



Click AC power switch for output, and then click AC power switch to turn off.

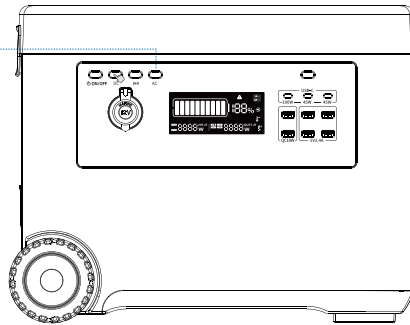

1. Click the AC switch to enable output of the AC port in startup state, and then click the AC switch again to disable the AC.
2. If the AC is enabled and the AC output port is free of any load, the AC will automatically shut down output 8 hours later, and the product will automatically shut down.
3. Please ensure that the load power is smaller than the output power of the port before using the AC output port.
4. When the AC output is not in use, please turn it off promptly to avoid battery loss caused by the power consumption of the inverter.
5. Hertz conversion: When AC is on, please press the AC switch for 3 seconds to switch to 50Hz/60Hz.

### 3.4 AC charging

For AC charging, please charge with the official standard AC charging cable. The AC charging plug shall be directly connected to the current wall that supports more than 15A. We do not assume any responsibility for the damage caused by the use of other unofficial power cables and failure to operate according to the specifications. The fast charging technology is specially designed for AC charging, which can be connected to the mains electricity to charge the product through the AC charging cable. In the abnormal case that the AC input current continues to be higher than 15A, the charging input port will start the self-protection function, and the charging overload protection switch on the product will talk automatically. After confirming that the product has no fault, you can press the charging overload protection switch to restore the charging.

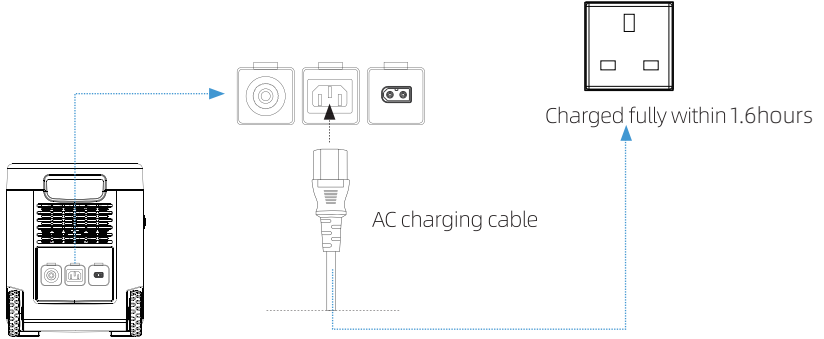

### 3.5 Solar panel charging diagram

#### How to charge energy storage for solar energy

To connect individual solar panels, please refer to the instructions for solar panels. The series and parallel modes of the four solar panels are mainly shown here. When the input exceeds 50V, the product will trigger overload protection. Moreover, high voltage may damage the product. When using solar energy to charge the product, check whether the output voltage of the solar panel is within the product specifications according to the User Manual to avoid damage to the product. We will not assume any responsibility for the damage caused by the use of other non-standard operations.

#### Series charging scheme (recommended scheme)

Users can connect 1-4 solar panels in series through the MC4 interface as shown in the figure, and then connect our MC4 to XT60 connection wire, and use XT60 connector to connect the XT60 interface of energy storage to charge the product.

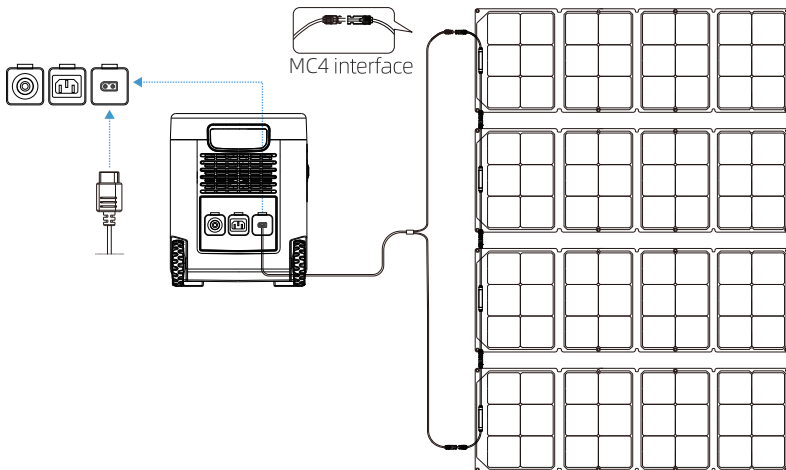

### 3.6 Car charger

The product can be charged by the car charging port on the car. Specifically, it shall be charged by the car after ignition and start, so as to avoid the loss of car battery and failure to start, and ensure that the contact between the car charger and the car charger input based cigarette lighter is well. If the loss is caused by the failure to comply with the regulations, the Company shall not assume the corresponding responsibility.

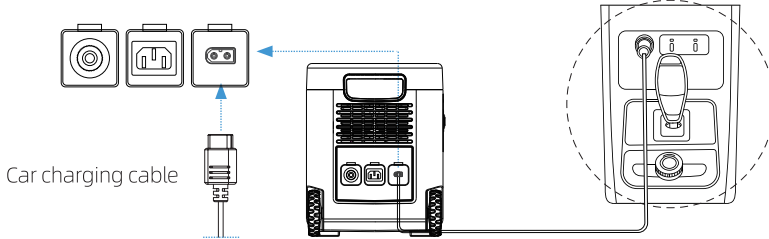

### 3.7 UPS function

This product supports UPS function. When you connect the power grid to the AC input port of this product through the AC charging cable, the electrical appliances can use the AC output port of this product to work (the AC power comes from the power grid, not the battery). When the power grid fails suddenly, this product can automatically switch to the battery power mode within 20ms. This function is a non-professional UPS function and does not support 0ms switchover. Do not connect it to devices that require uninterrupted power supply, such as data servers and workstations, or test multiple times to confirm compatibility before using it. It is recommended to use only one device instead of multiple devices at the same time to avoid overload protection. If the device cannot operate normally or the data is lost due to the failure to follow the instructions, our company will not assume the corresponding responsibility.

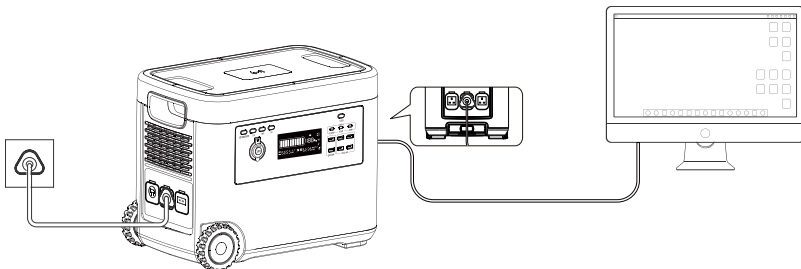

## 4.FAQ

### 1. What type of battery does the product use?

This product uses high-quality lithium iron phosphate batteries.

### 2. What equipment can be brought to the AC outlet of the product?

The AC output port of the product has high power ratings and maximum power to power most household devices. It is recommended to check the power of the equipment before use to ensure that the total power of all loaded equipment is lower than the rated power.

### 3. How to know the time of the product can be powered?

The liquid crystal display screen of this product will show the remaining power, and the equipment with stable general electricity can be estimated according to the time.

### 4. How to judge if the product is charging?

When charging, the LCD screen will display the remaining power, the power indicator ring outside the battery power percentage will start to rotate, and the input power display will indicate the charging status.

### 5. How to clean the product?

Please wipe the product with a dry, soft, clean cloth or paper towel.

### 6. How are products stored?

When storing, please turn off the product firstly, and then store in a dry, ventilated place at room temperature. Do not place this product near water sources. For long-term storage, it is recommended to discharge the battery to 30% and then charge it to 60% every three months to extend the service life of the product.

### 7. Can I carry this product on the plane?

No.

### 8. Why does it sound when it is used?

The product adopts an air-cooled cooling system with built-in fan to help heat dissipation, so slight noise is normal during use.

### 9. Is it normal for the product to work slightly hot?

It is normal for this product to have a slightly hot while charging/discharging. This product is in line with national safety standards. You can use it at ease.

### 10. How to deal with the triangle symbol flashing and Didi alarm sound on the LCD screen during operation or use of this product?



If the product is used in the process of warning prompt and Didi alarm sound, the several reasons shall be excluded, such as buzzer alarm and flashing triangle symbol for high temperature protection, low temperature protection, over discharge protection, over charge protection, overload protection, short circuit protection and over current protection, and the product can be restored to normal work after being excluded in several aspects. If an alarm occurs during the use of the product and the alarm icon does not disappear after restarting the device, please stop using the product immediately (do not charge or discharge the device).

If the information above cannot solve your problem, please contact customer service for consultation.

### 11. How to deal with the triangle symbol flashing and Didi alarm sound on the LCD screen when the product is used due to high internal temperature?

Please confirm whether the inlet and outlet of the product are unblocked, remove the cause and automatically resume use after the temperature decreases.

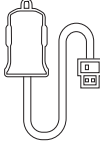
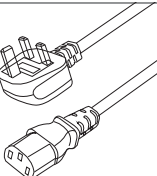
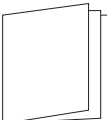
## 5.Package contents

			
Car charging cable	AC charging cable	User Manual and warranty card	D5-2500W

## 6.How to maintain and repair

1. It is recommended to use or store the product at an environment of 20°C to 30°C, away from water source, heat source and other metal objects.
2. In case of a long-term storage, please charge and discharge the product once every 3 months (that is, discharge the product to 30% and then charge it to 60%).
3. For safety, please do not store the product in an environment of higher than 45°C or lower than -10°C for a long time.
4. In order to prolong the service life of the battery, it is recommended to use the product in the environment of 20°C to 30°C.
5. If the power of this product is less than 10% after use, please charge it to 60% before storage. If left idle for a long time in the case of serious power shortage, it will cause irreversible damage to the cell and shorten the service life of the product.
6. If the power supply of the product is seriously insufficient and the idle time is too long, the product will enter deep sleep mode, and the product can only be restored after being charged before being used again.

**Warning!** Please do not charge immediately after full load discharge. For the service life and use safety of battery, please wait for 1 hour of cooling before charging! After full load discharge, the tips of over temperature will be displayed while charging the machine immediately, which is a normal phenomenon. Please wait 1 hour before charging.