

YU XIANG

www.yuxiang-rc.com

User Manual

F11S



CE

FC



MADE IN CHINA



Contents:

Introduction	1
Accessories List	1
Notes	2
Warnings	2
Safety Precautions and Warnings	2
Helicopter Parameters	3
Warnings and Battery Usage Guidelines	3
Battery Charging	3
Battery Functions and Indicators	4
Remote Control Functions	5
Display Contents	5
Description of Switch Functions	6
Aircraft and remote control to frequency matching	6
Description of the aircraft status indicators	7
Gyroscope Calibration	7
Compass calibration	8
Manual Start/Stop Motor	9
First Flight	9
Flight Modes	10
Lower Vision Mode Notes	10
Auto Return	11
Return Point	11
Smart Return	12
Straight Return	12
Smart Low Power Return	12
Failsafe Return	12
One-button Landing	13
Round Flight	13
Heart-shaped Flight	13
Flight Restriction	13
Propeller Pitch Setting	13
Common Troubleshooting	14
ELRS Receiver Channel Switch Settings Corresponding to Flight Modes	15

Introduction:

This aircraft model is a 1:32 scale reduction of the SH-60 Black Hawk helicopter with high simulated exterior details. It has two removable side doors, shock-absorbing landing gear and awesome lights, and comes with two-way transmission for remote control communication, equipped with intelligent flight control system, which is perfect for beginners. It is also a good static model of the exhibit.

It uses a built-in GPS / geomagnetic smart flight control system, direct drive motor, smart battery, multi-functional GPS flight self-stabilization mode, optical flow stabilization mode, and manual height setting mode. In addition, it also has a flight fence, one-button return, smart low power return, failsafe return, one-button landing, and other safe flight modes.

Please read the detailed instructions in this manual carefully before operating your helicopter, as this will help you understand the product. Incorrect operation can cause damage to the model aircraft, wasting your valuable time and money.

Accessories List:

Serial number	Accessory	Quantity
1	Color Box	1
2	Sponge Inner Package	1
3	User Manual	1
4	Helicopter	1
5	Launcher	1
6	Transmitter	1
7	Adapter	1
8	Battery 11.1v 1800mAh 30C	1
9	Phillips Screwdriver/Hex Wrench	1
10	Main Propeller	4
11	Tail Propeller	1

NOTE:

All descriptions, warranties, and other ancillary documents are subject to change at the sole discretion of our company. To obtain the latest product information, contact us.

WARNING:

Please read the entire user manual to familiarize yourself with the functions of the product before operation. Any failure to operate the product properly may result in damage to the product, loss of personal property, and cause serious injury. This is a complex product to operate for hobby purposes. It must be operated with care and common sense and requires some basic mechanical ability. Failure to operate this product in a safe manner may result in personal injury as well as damage to the product or other property. The product is not intended for use by children without direct adult supervision. This manual contains safety, operating, and maintenance instructions. Before assembly or use, please read and follow all instructions and warnings in the operator's manual to operate properly and avoid damage or serious injury.

Safety Precautions and Warnings:

- 1.Age advice: not suitable for children under 14 years old. It is not a toy.
- 2.Always operate your model in an open space away from all kinds of vehicles, traffic and people.
- 3.Follow operating notices, warnings, and any supportable devices (chargers, batteries, etc).
- 4.Keep the product away from any chemicals. Keep children away from any small parts and electrical equipment.
- 5.Always keep away from water. Special attention is paid to the fact that this product is not waterproof and it will be damaged by moisture.
- 6.Do not put any part of the model in your mouth as this may result in serious injury or even death.
- 7.Do not operate your model with low voltage launcher batteries.

Helicopter Parameters:

Length	485mm
Height	155mm
Weight	560g
Main Propeller Length	450mm
Tail Propeller Diameter	73mm
Battery Specification	11.1v 180mAh 30C
Flight Duration	12Min
Main Brushless Motor	4306
Brushless Tail Motor	1206

⚠ Warnings and Battery Usage Guidelines:



To ensure safety, please use the original standard charger

⚠ WARNING: It is highly recommended to use the original battery charger

⚠ NOTE: When the battery voltage is below 1 1.1V, the lithium battery may be damaged and may not be charged properly.

Battery Charging:

1. When the charger is not connected to the battery, the red light is on.
2. The indicator light is flashing when charging.
3. The indicator light stops flashing when charging is complete.
4. When charging is complete, disconnect the power and remove the battery from the charger.

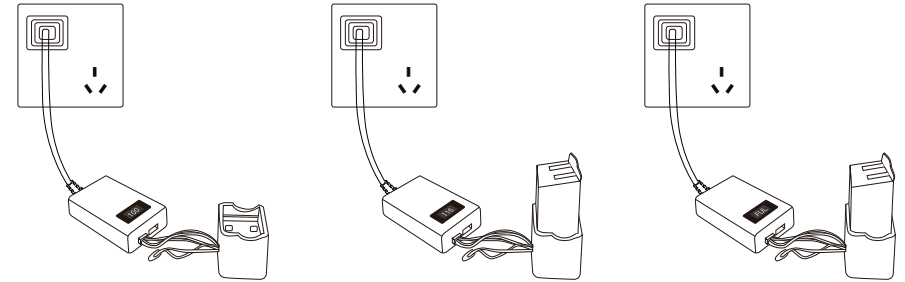

⚠ WARNING

1. For maximum safety, please monitor the battery while charging.
2. Please do not let your child do the charging by himself unless accompanied by adult supervision at all times.
3. Please use the original standard charger of this product for charging. There may be a risk of fire and explosion with unknown chargers.

Battery Functions and Indicators:

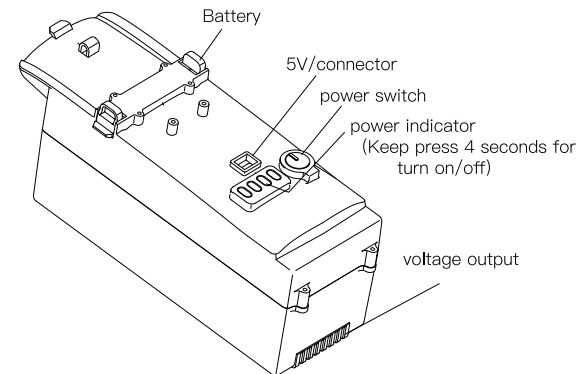

Status	Power
●●●●	4lights on 100%
●●●○	3lights on 75%
●●○○	2lights on 50%
●○○○	1lights on 25%
○○○○	4lights flashing 电量不足

⚠ WARNING:

Please turn off the battery power after use, leaving it on for a long time may shorten the battery life. Please remove the battery after using, so as not to damage the battery by over-discharge.

Remote Control Functions:

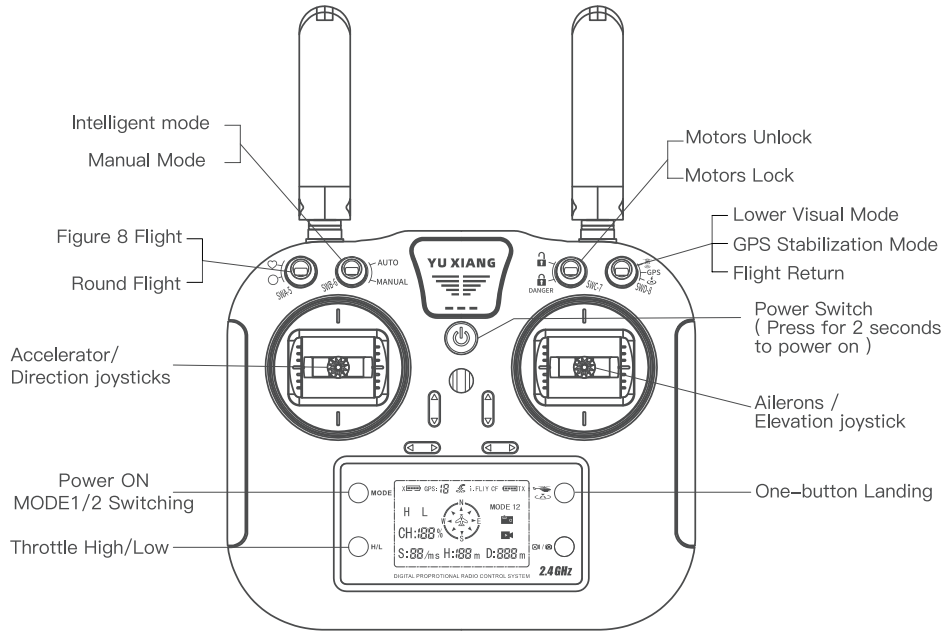

Display Contents:

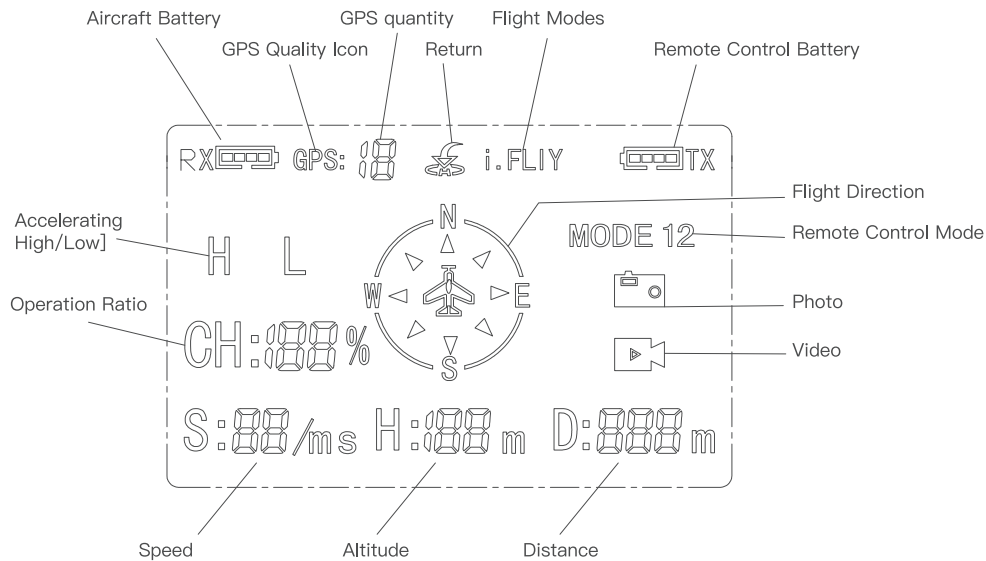

Right Accelerator



Left Accelerator



Description of the switch function:

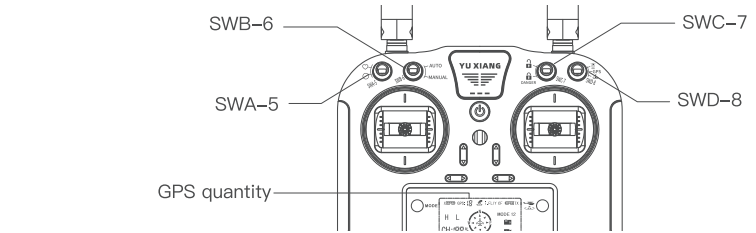

Toggle the switch upwards, and the helicopter will record the current coordinates, then fly horizontally figure 8 based on these coordinates.

SWA-5 In GPS mode, toggle down the reset switch, and the aircraft records the current coordinates and flies in a horizontal circle around the center with these coordinates.

SWB-6 Switch up for auto-stabilization attitude mode

SWB-6 Switch down for completely manual mode, shielding the lower visual positioning mode and GPS mode. **This mode is suitable for poor GPS signal, geomagnetic data interference and caused by the aircraft can not be accurately positioned or serious yaw, and for manual control and emergency landing use.**

SWC-7 Switch up is motor unlock, normal flight should keep the switch on top.

SWC-7 Pay special attention!
Switch down is to lock the aircraft, it will stop all movements (including motors and servos), so use the lock switch carefully during the flight, the in-flight stop will cause the aircraft to crash, unless a serious fault is detected during the flight (such as air hit, aircraft not under control, rapid ascent or descent, aircraft not under attitude control), and SWB-6 switch off to manual mode still can not control the aircraft, then switch to lock mode in the air so as to force a crash.

SWD-8 Switch up is the lower visual positioning mode. The maximum flight height of the aircraft flying is 6 meters, suitable for GPS-poor scenarios.

SWD-8 Switch in the middle position is GPS positioning mode, which can achieve accurate positioning of the aircraft, stable flight and intelligent flight.

SWD-8 Switch down is the return, at this time the aircraft instantly and automatically return to land, after landing and turning off the motor.

Aircraft and remote control to frequency matching:

If you are purchasing a complete set of remote control and aircraft, they have been successfully frequency matched at the factory and you can directly power on and use them. In other cases, please use the following method for frequency matching.

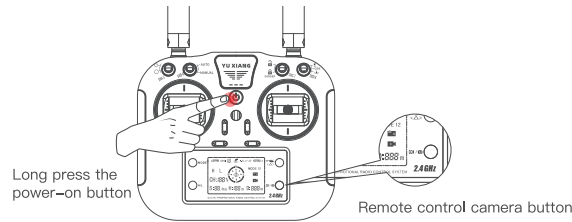

- 1 Press and hold the camera button and the power button of the remote control, and it will continuously make beeps.
- 2 Power up the aircraft and turn on the smart battery, with the yellow light of the aircraft indicator flashing fast.
- 3 Keep the aircraft stationary within 0.5m distance from the remote control.
- 4 The remote control makes two consecutive beeps, and the display shows the aircraft pattern and RX power, which means the frequency matching is successful, here the indicator is restored.
- 5 If the frequency matching is not successful, please repeat the above steps and try again.

⚠ Note: After successful frequency matching, the indicator light will be displayed accordingly depending on the current remote control switch position, please refer to the light indication.

Description of the aircraft status indicators:

- 1 Fast flashing yellow light: Self-test of the aircraft
- 2 Long red light: under visual positioning mode
- 3 Slow flashing green light: GPS star search and positioning
- 4 Long green light: GPS positioning mode
- 5 Long yellow light: manual attitude mode

⚠ Warnings & Exceptions

Slow flashing red light: Level 1 low power

Fast flashing red light: Level 2 low power

Flashing alternately between red and yellow lights: ground magnetic data error, need to recalibrate

⚠ Note: After frequency matching between the aircraft and the remote control, different mode lights will be displayed accordingly according to the remote control switch position indication.

Gyroscope Calibration:

After the successful frequency matching of the aircraft, please push the left joystick of the remote control (MODE2) to the uppermost corner and the lowermost corner of the right joystick for 2–3 seconds as shown in the picture, when the yellow light of the aircraft indicator flashes fast, the indicator has a fast flashing light to a long green light, calibration is complete.

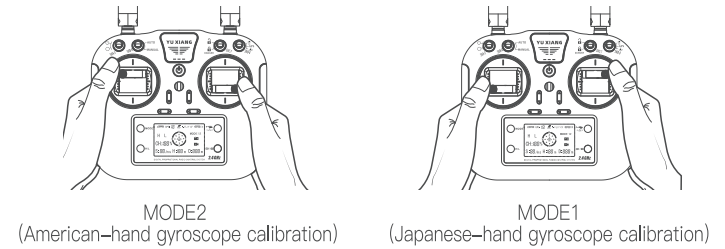

When performing gyroscope calibration, be sure to place the aircraft on a level surface, otherwise it will affect the original calibrated gyroscope and it is not necessary for the user to calibrate it again. Only if the initialization cannot be exited or if yaw exists in manual attitude mode, then the gyroscope needs to be recalibrated.

After the calibration is completed, the indicator light will be displayed according to the current remote control switch position, please refer to the indicator light description for details.

Compass Calibration:

Please put the successful frequency matching aircraft on the ground, the remote control (MODE2) as shown in the picture left-hand joystick is located in the lower left corner, the right-hand joystick is located in the upper right corner, now enter the gyroscope calibration, the indicator yellow light is flashing fast which means into calibration compass.

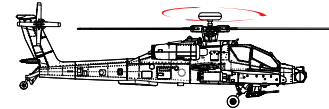
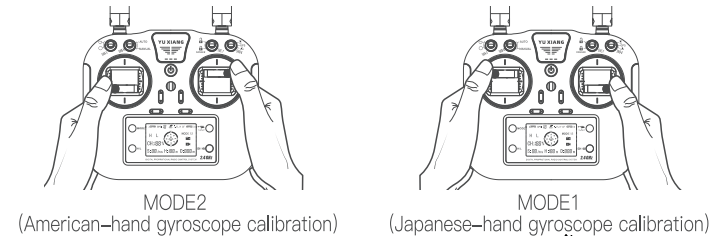

The first step of horizontal rotation

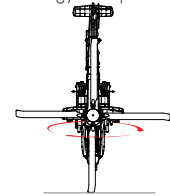

The second step of upright rotation

The aircraft rotates horizontally until a fast flashing yellow light changes to a fast flashing green light, then stand it up again and rotates until a long green light is on and the compass calibration is complete.

⚠ NOTE: Please recalibrate your compass for a safer and more stable flight on your first flight or change of flying site.

When calibrating, please keep the aircraft at a distance of more than 1 meter from the ground.

Do not calibrate in areas with strong magnetic fields, such as magnetic mines, buildings with underground reinforcement.

Please do not carry magnetic materials with you when you calibrate and do not do so in the vicinity of large pieces of metal.

Manual start/stop motor:

Start motor

The operation to swing outward joysticks action to start the motor, then immediately releasing them, accelerating joystick up to push more than 50%, the aircraft takes off.

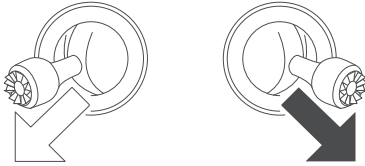

Stop Motor

After landing, accelerate the joystick to the lowest position for over 3 seconds, and the motor will stop.

In-flight Stop

During the flight, if the SWC-7 switch is toggled down , the aircraft will stop all movements (including motors and servos), so please use the lock switch carefully during flight. Sudden stop in flight will cause the aircraft to crash, except when a serious malfunction is detected during flight (e.g. impact in the air, aircraft not under control, rapid ascent or descent, aircraft not under attitude control), and the SWB-6 switch to manual mode is still unable to control the aircraft, then switch to lock mode in the air to force a crash.

First Flight:

If you are not experienced with the F11S, please take a few minutes to learn about them before attempting your first flight.

Throttle



Rudder

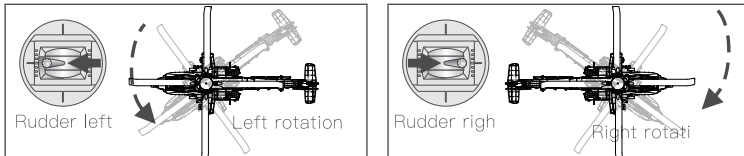

Elevator

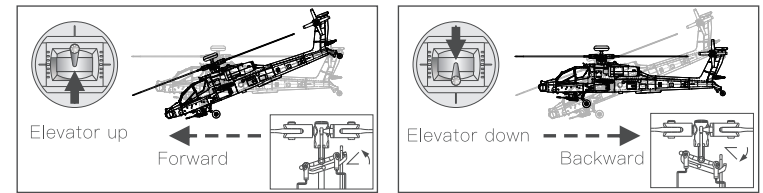

Aileron

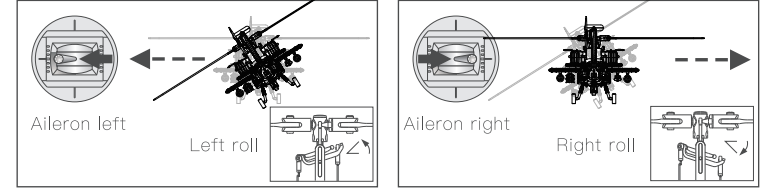

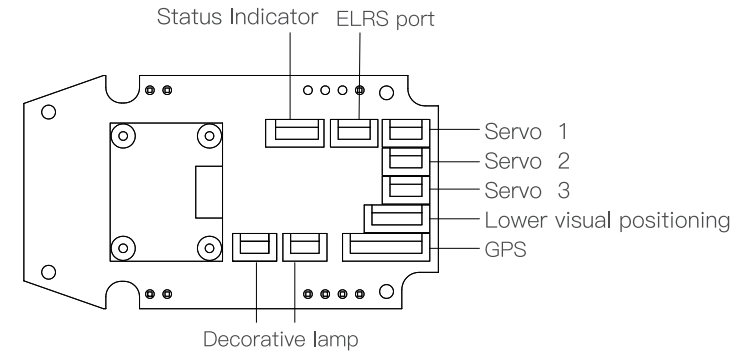

Flight Control Interface Diagram



Flight Modes:

The F11S allows GPS stabilization mode, optical flow stabilization mode and manual attitude mode, which can be switched by remote control.

The middle position of the remote control  GWD-8 switch, GPS stabilization mode, the use of GPS + geomagnetic module, to achieve precise hovering, stable flight, smart flight, accurate positioning of the aircraft, the maximum tilt angle of 25°, the maximum flight speed of 5 m/s.

The upper position of the remote control  GWD-8 switch, lower visual (optical flow) positioning mode, is suitable for environments without GPS signal or poor GPS signal. Turn on the lower visual positioning mode. Use lower vision positioning system on open and flat ground, limited flight height is 6m, flight speed is 1m/s in L gear, 2m/s in H gear.

Remote control SWB-6 switch toggle to the bottom position,  open the manual attitude mode, this mode hand-controlled motion mode, shielding GPS and lower vision mode, can strengthen the ability to control the aircraft, but also for GPS geomagnetic data confusion, the aircraft is not controlled yaw situation, which can be urgently switched to hand-controlled mode emergency landing.

Notes on the lower visual model:

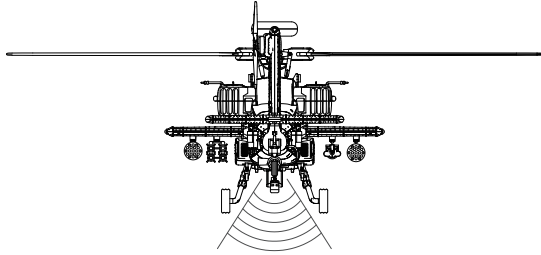



Please be aware of your surroundings. The visual system only plays a supporting role under limited conditions and cannot replace human judgment and control. Users should always pay attention to the surrounding environment during the flight, maintain control of the aircraft throughout and be responsible for the control.

The lower vision system tracks the lowered objects through the lens, and the limited takeoff height is 6 meters, please avoid taking off on the building roof. Flying over the building roof will cause the lower vision to fail and thus the aircraft will drift. In this case, you should immediately fly the aircraft back or immediately switch to GPS stabilization mode.

The lower vision system is unable to recognize surfaces and environments without textural features, as well as to work properly in low or excessive light intensity. The lower vision system does not work in the following scenarios.

- 1 Pure color surface (listed as pure black, pure white, pure red, pure green)
- 2 Surface with strong reflections or reflections.
- 3 Surface of water or transparent objects.
- 4 Surface of moving objects (listed as above the flow of people, shrubs and grasses blown by high winds)
- 5 Scenes with intense and rapid changes in lighting.
- 6 Extremely dark or bright object surfaces.
- 7 The surface of materials that have a strong absorption or reflection effect on infrared light.

Auto Return:

F11S-GPS has the automatic homing function. The main homing mode is intelligent homing. The intelligent low power homing is out of control. The aircraft has successfully recorded the homing point and, under the condition of good positioning, when the user starts automatic homing (the lowest position of SWD-8 switch ) , the low power of the aircraft triggers intelligent low power homing. The remote controller and the aircraft lose the communication signal to trigger the out of control homing. The aircraft returns to the homing point and lands. When the aircraft enters the homing, the homing icon appears on the remote control display  , and the sound prompts continuously

Return Point:

After the aircraft is powered on, the first satellite search will be a little longer, wait until the indicator light changes from a slow flashing green light to a long bright green light, the GPS icon and the number of satellites appear on the remote control display, and the remote control emits a beep before the motor can be unlocked in GPS mode. At this time, the aircraft also records the coordinates of the current takeoff point, recorded as the return landing point.

 NOTE: If the number of satellites is not enough on transmitter screen it means the gps quality is not good. If the transmitter display screen does not appear GPS sign, the GPS mode can not be unlocked to take off. If the takeoff is in down visual mode and manual attitude mode, the aircraft is recorded to the position where the satellite mass is reached during the actual flight as the return point. This has a risk, users should circumvent such an operation.

Smart Return:

Smart return is initiated by the user, SWD-8 switch  toggle to the bottom position to open the smart return. The SWD-8 switch is turned to the middle GPS mode on the way to smart return, and the user can regain control of the aircraft after exiting smart return.

Straight Return:

When the user takes the initiative to control the smart return, the remote control will emit three beeps and the display will show the return icon. The aircraft will make a straight line return, the process is as follows:

- 1 The aircraft records the return point
- 2 Smart return is set off
- 3 The aircraft brakes first, and turns towards the return point to start the return flight.
A. When the return distance > 15 meters, the aircraft adjusts the nose toward the return point, and then rises vertically to the set return height and return, if the current height is more than 10 meters then return directly; if the height is less than 10 meters, then rise to 10 meters height and return.
B. When the return distance is 3-15m, the aircraft will adjust the nose and face the return point with the current altitude, if the current altitude is <5m, it will rise to 5m and then return.
C. If the return distance is <3m, the aircraft will land directly.
- 4 The aircraft automatically flies back to the return point and then the landing begins.

Smart Low Power Return:

To avoid unnecessary danger due to insufficient power, F11S-GPS will intelligently determine whether the current power is sufficient according to the flight location information. If the power is only enough to return or trigger the level 1 return voltage, the aircraft will automatically return.

When detected into the Level 1 low power, the aircraft will return to 25 meters from the takeoff point, 20 meters altitude range and hover, and as a flight fence. At this time, you can control the aircraft to fly inside this fence until it enters the Level 2 low power, the aircraft will land at the return point and power off.

Note: Upon entering the low power return, the remote control will have an alert and the display RX power flashing.

In a low power return state, the aircraft cannot be cancelled to return.

If the aircraft does not exceed 25 meters in distance and 20 meters in height before entering the Level 1 low power, it can be controlled to fly within this limit.

The aircraft goes too high and too far. When in a low power return, it is possible to go right into Level 2 low power and return directly to land.

 NOTE: In lower vision mode and manual mode, the aircraft will not enter smart low power return and will perform the in-situ landing. Please pay close attention to the flight mode and the power of the aircraft.

Failsafe Return:

When the connection with the remote control is lost for more than 3 seconds (the aircraft pattern and RX power icon in the center of the remote control display disappears), the aircraft will return.

When connected to the remote control again and the signal continues (the aircraft pattern and RX power appear on the remote control display), the aircraft will terminate the return flight and hover to wait for the operation command.

One-button Landing:

When long-press the One-button Landing, the flying aircraft will land in place and will not return to the take-off point. The remote control can control the aircraft during the landing process. During the process, you can push up the remote control accelerator joystick to release the landing command, or you can release it by pressing the button again. At this time, the aircraft is hovering and waiting for the operation command.

Round Flight

Toggle down the SWA-5 reset switch and the aircraft will record the coordinates and fly in a horizontal round flight with these coordinates as the center. Toggle down the switch or aileron/elevation joystick again to release the round flight.

Figure 8 Flight:

In GPS mode, the SWA-5 reset switch is toggled upward, the aircraft records the coordinates and flies an up and down Figure 8 Flight pattern with these coordinates. Toggle the SW-5 switch again to deactivate the current flight mode.



Flight Restriction:

For safety reasons, the F11S aircraft is limited to a flight altitude of 120 meters and an electronic fence with a flight distance of 350 meters.

Propeller Pitch Setting:

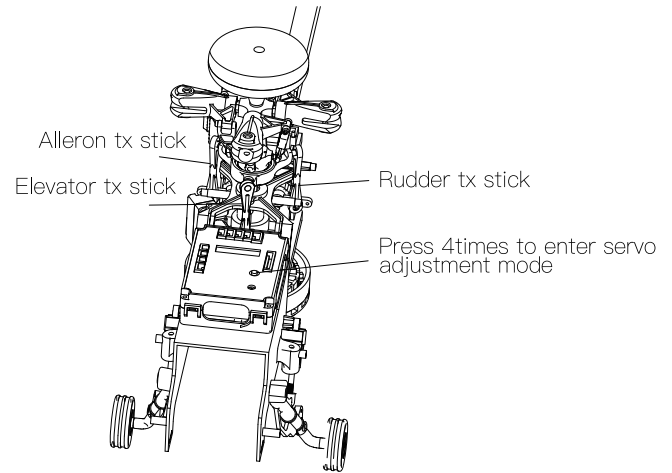
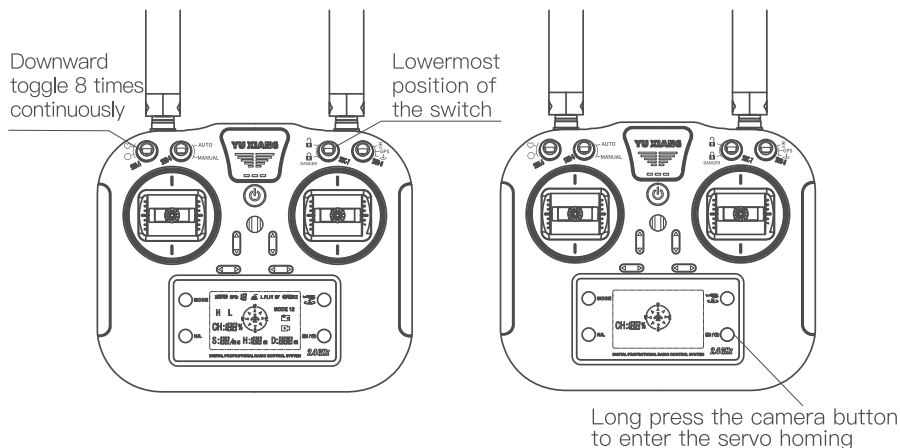
When users change the rudder or other major accessories, it may change the propeller pitch, and adjust them to help flight stability. Please follow the steps below to set it.



- 1 The remote control is connected to the aircraft for frequency matching.
 - 2 Toggle the SWC-7 switch  of the remote control to the bottom to lock the aircraft. toggle the SWA-5 switch down 8 times continuously to enter the propeller pitch setting. The remote control display only shows the aircraft and channel pattern.
 - 3 Long press the camera button with a beep sound, then all servos enter the servo homing.
 - 4 Adjust the corresponding servo through the joystick until the aircraft cross plate is horizontal and the propeller angle is 0 degrees, then toggle the remote control SWC-7 switch  to the top, the remote control will resume full screen display and the propeller pitch setting is completed.
-  Note: The experienced person is needed to guide the propeller pitch setting.

Common Troubleshooting:

Serial Number	Problem	Solutions
1	GPS mode cannot be unlocked for takeoff	1 The GPS icon does not appear on the display before the flight is unlocked. 2 Please make sure the remote control switch is in the correct position.
2	After the aircraft is powered up, the remote control display does not show the aircraft data.	1 The power-up is so fast that the remote control is too late to respond. 2 Re-power the aircraft.
3	The light keeps flashing rapidly after the aircraft is powered on.	When the aircraft is in the gyroscope detection state, please put it on a stationary plane or on the ground.
4	The aircraft cannot hover or tilt to one side after takeoff.	Recalibrate the gyro by placing the aircraft on relatively level ground or table.
5	The aircraft vibrated badly.	1 Check the propeller blades for breakage and replace them as a whole. 2 Please check if the main cross shaft of the aircraft is bent and replace it in time.
6	The aircraft cannot be unlocked and the indicator light is flashing rapidly.	The battery voltage is too low, please give a full charge.
7	Unstable flight in high winds.	The craft is suitable for use in weather conditions less than force 4 winds.
8	Unable to hover, keep circling.	The compass data is wrong, please recalibrate it.

ELRS Receiver Channel Switch Settings Corresponding to Flight Modes

ELRS Receiver Settings:** (Receiver connects to power continuously 3 times to enter binding mode)

- CH1: Ail ±100 Left/Right Roll
- CH2: Ele ±100 Forward/Backward
- CH3: Thr ±100 Throttle
- CH4: Rud ±100 Steering
- CH5: SD Three-position switch (Flight mode switch)
 - 100: Optical Flow Mode 0: GPS Mode +100: Return-to-Home Mode
- CH6: SA Two-position switch (Emergency Stop Switch)
 - 100: Control Allowed 100: Emergency Stop
- CH7: SC Three-position switch (Auto Route Switch)
 - 100: In GPS mode, switch from 0 to -100, the aircraft executes circular route command.
 - 0: In GPS mode, route command off.
 - +100: In GPS mode, switch from 0 to +100, the aircraft executes figure-eight route command.
- CH8: SB Two-position switch (Manual Mode Switch)
 - -100: Auto Mode (flight mode determined by CH5 three-position switch position)
 - 0 or +100: Altitude Hold Mode (Optical Flow and GPS off)
- CH9: SI Button switch (One-key Inverted Flight)
 - In GPS mode, switch from -100 to +100 to activate the one-key inverted flight function of the aircraft.

Following the T20 Open-source Communication Protocol Remote Control Settings Parameters:

Channel Settings

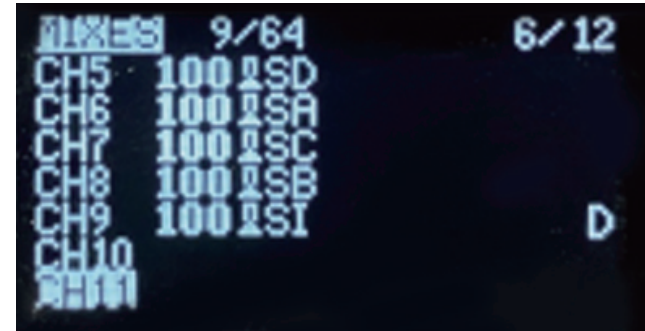

Communication Frequency Setting

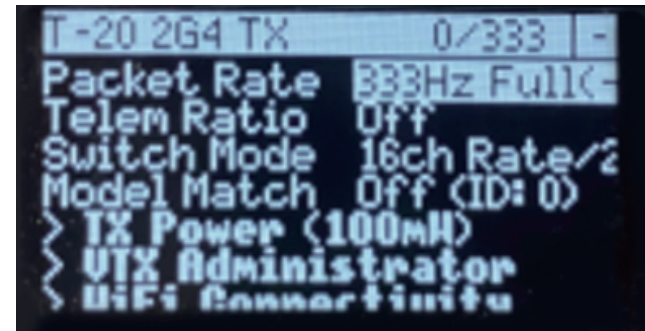

Communication Mode Setting



All the above parameter settings are based on the T20 open-source protocol remote control. For differences in the interface and parameters of specific remote controls, please refer to the remote control's instruction manual in detail.