

***iMars***

**CAR JUMP STARTER**

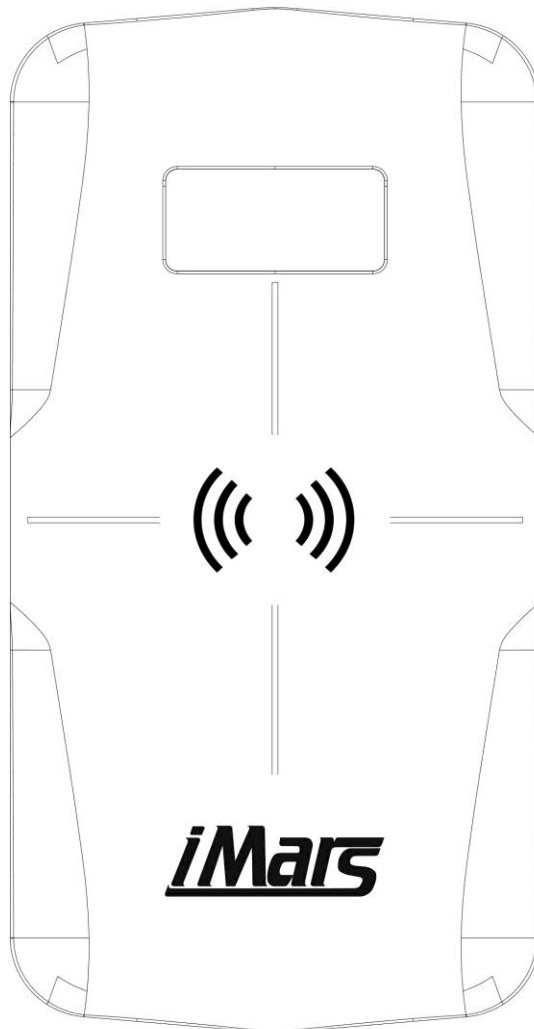

**J03**

**USER MANUAL**

## Product Overview

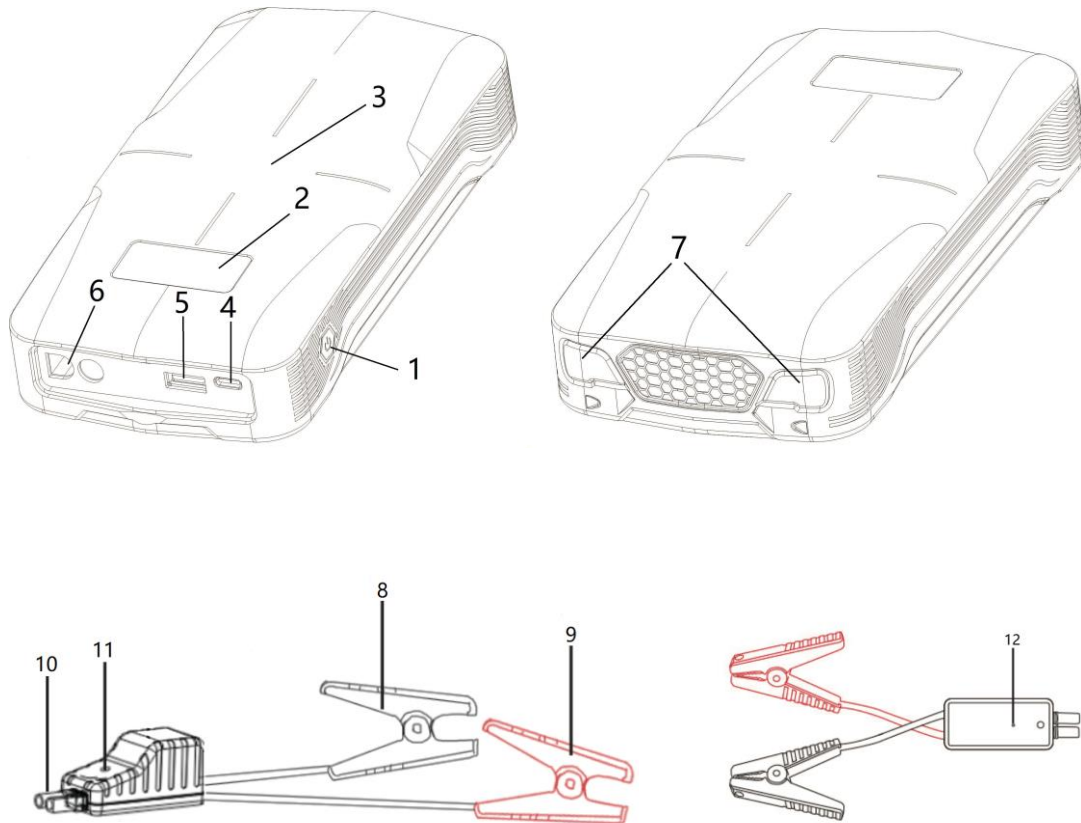

NO.	Function	Operation
1	ON/OFF Button (Multifunctional)	Press the button to charge your devices.  Press the button to see the remaining capacity.  Long press the button to turn on/off the flashlight.
2	LED Display Screen	Shows the percent power.  Shows charge and discharge status.  Shows wireless charging status.  Shows SOS status.
3	Wireless Charging	Wireless charging feature only works on devices with the

	Pad	wireless charging option.
4	USB C Input Port	Charge the jump starter (via USB-A to USB-C cable).
5	USB Output Port (QC 3.0)	Charge your devices (QC 3.0 compatible) faster, with 75% increase in speed.
6	Jump Starting Port	Insert the plug into the jump starting port.
7	LED Flashlight	Flashlight modes: Solid, SOS, Alert, and Off
8	Black Clamp	Connect the black clamp to the negative terminal of the car battery.
9	Red Clamp	Connect the red clamp to the positive terminal of the car battery.
10	Plug	Insert the plug into the jump starting port.
11	Battery Clamp Indicator Lights	Show the status of the smart battery clamp.
12	Force Start Button	You need to press this button if the car battery voltage too low.

## Getting Started

### Charging the jump starter:

1. Connect the jump starter and the power source via the USB C cable.
2. Short press the ON/OFF button to turn on the product. While charging the jump starter, the LED Display Screen will show the percent power increased. Once it is fully charged, the LED Display Screen will show

100%.

3. Unplug the cable when no charge is required.

**NOTE:**

- When using product for the first time, please make sure that the jump starter is fully charged.
- Please use the provided USB C cable to charge the product.
- Wall adapter is not included in the package.

**Charging your USB devices:**

1. Connect the product and your iPhone, smart phones or other electronic devices via USB cable.
2. Press the ON/OFF button to turn on the product.
3. Unplug the cable when no charge is required.

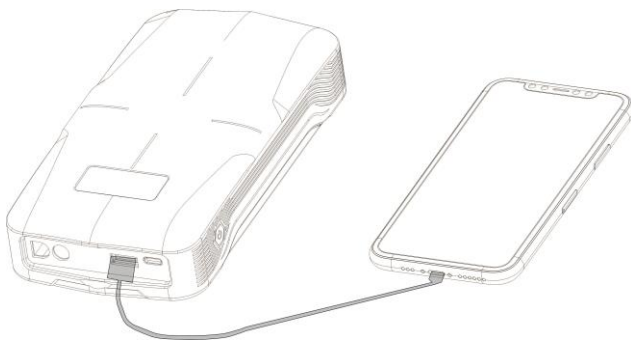

**Wireless Charging your device:**

Press the power button once to enable wireless charging function. Place the device on top of wireless charging icon to start. You may need to

adjust the orientation to have the best charging.

**NOTE:** The wireless charging feature only works on devices that allow Qi (inductive) wireless charging. Only use the wireless charging pad with Qi-certified devices.

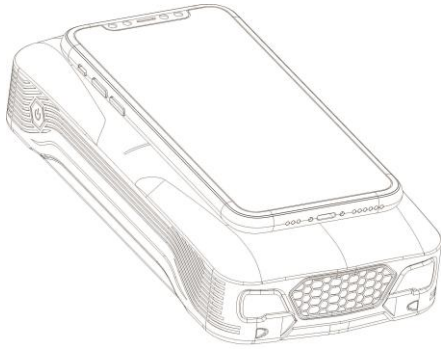

### **LED flashlight**

Long press ON/OFF button for 3 seconds to turn on the light. Press ON/OFF button shortly to switch modes among Solid, SOS, Alert and Off.

### **Jump start your car**

#### **NOTE:**

- This product is for 12V car (up to 6.0L petrol or 4.0L diesel engine) only.
- Check to make sure that battery level is above 50% before you use it to jump start your car.

**Step 1: Insert the plug of the smart battery clamp completely into the jump starter.** If the green and red light indicators on the battery clamp are flashing alternately, you are safe to move on to the next step.

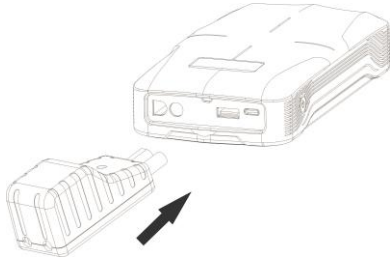

**Step 2: Connect the red clamp to the positive terminal (+) of the car battery and connect the black clamp to the negative terminal (-) of the car battery.** If the green and red light indicators on the battery clamp are flashing alternately, you are safe to move on to to the next step.

However, if the red indicator light is on:

1. The battery clamp may be connected in reverse. If so, you need to disconnect the battery clamp from the vehicle and the jump starter.
2. Adjust the clamps for maximum contact with battery terminals.

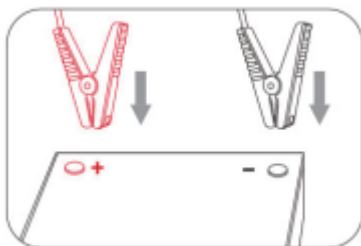

**Step 3-a: Start your car.**

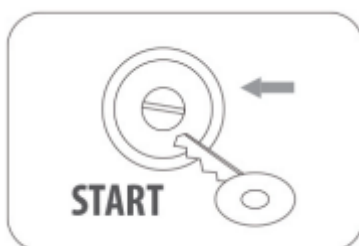

- *If you failed to start your car, you need to disconnect the battery clamp from the vehicle and the jump starter. Wait for at least 30 seconds, then try again.*
- *If you failed to start your car after 3 attempts, you can use the **force start function**. See step 3-b.*

**Step 3-b (optional): Force start function.** First please make sure that the clamps are connected to the correct polarity battery terminal. Then, hold the force start button for 3 seconds to start your car. When the indicator light of the smart clamp is solid green, you need to start the vehicle within 30s.

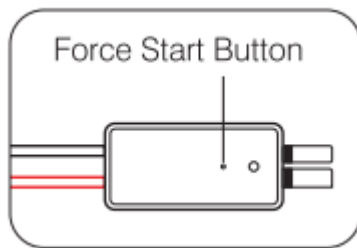

**Step 4:** Once your car is started, remove the battery clamp from the car battery and the jump starter within 30 seconds.



**If any of the following situations, the smart clamp turns protection on.**

LED Indicator	Situations
The red/green light will flash	Ready to work
The red/green light will flash	Work status
The red light is always on	<p>1. Battery clamp is reversely connected. -Check whether the clamp is reversely connected.</p> <p>2. The clamp is short-circuited. -Check whether two clamps together connect or connect both clamps to the same piece of metal.</p>
The red light is always on	<p>Reverse charging protection, the voltage of the car battery is higher than 12.6V. -No jump starter needed, the car battery is enough to start your car.</p>
The red light flashes quickly	<p>The temperature of the clamp exceeds 65(+/-5) degrees. -Remove the clamp until the red/green light flash</p>
The green light flashes slowly	<p>The voltage of the jump starter is too low. -Try to replace the jump starter or charge it in time.</p>



## **Cautions**

1. Use the original smart battery clamp to start the car.
  2. Do not use this unit if any cable clamp or cord is damaged.
  3. Do not connect two clamps together when the product is turned on.
- Do not connect both cable clamps to the same piece of metal. Otherwise, the jump starter will be damaged.

## **Care and Maintenance**

1. DO NOT use the product to start a bulging car battery.
2. Store the product in a shaded, well-ventilated area.
3. Please handle the product with care and do not abuse it. Avoid dropping or striking the product heavily and repeatedly.
4. DO NOT disassemble or modify the product.
5. DO NOT use detergents to clean the product.
6. DO NOT place the products in a high-temperature environment for long. The operating temperature of this product is  $-20-60^{\circ}\text{C}$ . The storage temperature of the product should not exceed  $50^{\circ}\text{C}/122^{\circ}\text{F}$ .
7. Check the battery level of the product at least once every three months and charge the product in time.
8. Keep the product away from children and pets.

## Specifications

Brand	iMars
Model	J03
Capacity	16000mAh/59.2Wh
Type C input	5V/2A
USB output	5V/3A, 9V/2A, 12V/1.5A
Wireless Charging	5V/2A, 10W max
Start current	650A (last for 1s)
Peak current	1300A (last for 0.2s)
Short circuit protection	Effective
Over-discharge protection	$\leq 13V \pm 0.3V$
Over-temperature protection	$> 65^{\circ}C \pm 5^{\circ}C$
Reverse polarity protection	Effective
Reverse charging protection	$\geq (12.6V \pm 0.3V)$
Dimensions (L*W*H)	180*92*36mm

## FAQ

Q: How to turn off the product?

A: This product will power off automatically when no load is detected or when charging is complete.

Q: How long does it take to fully charge the jump starter?

A: About 5 hours through the Micro USB input port or Type C input port.

Q: How many times can this product start the vehicle with full capacity?

A: About 15 times.

Q: How many times can this product fully charge my cell phone?

A: It depends on the battery capacity of your cell phone. For example, iPhone 8 can be fully charged 3~4 times.

Q: What are the safety protections of the smart battery clamp?

A: Short-circuit protection, over-temperature protection, low Voltage Protection, over-voltage protection, over-charge protection, over-discharge protection, over-current protection and reverse polarity protection.

### **Package Contents**

1 x 16000mAh Jump Starter

1 x Smart Battery Clamp

1 x USB Type C Cable

1 x User Manual

1 x Carry Pouch

1 x Gift Box